

MULTIPHYSICS SIMULATION

Sponsored by
 COMSOL

Special Advertising Section to
IEEE Spectrum

JUNE 2012



TOPOLOGY OPTIMIZATION LEADS TO BETTER COOLING OF ELECTRONIC COMPONENTS

PAGE 8

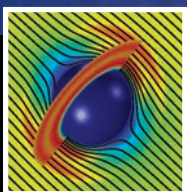

METAMATERIALS
MAKE PHYSICS
SEEM LIKE MAGIC

PAGE 3



UPGRADING THE
NUTS AND BOLTS OF
THE ELECTRICAL GRID

PAGE 22

SIMULATION— MORE THAN MEETS THE EYE

By **JAMES A. VICK**, SENIOR DIRECTOR, IEEE MEDIA;
PUBLISHER, IEEE SPECTRUM

TODAY SIMULATION IS ubiquitous. It has been embraced by virtually every industry that designs and innovates new products and services.

There has been remarkable progress in simulation methods. In fact, the performance of improved algorithms has matched that of improved hardware over the last half century. The combined effect of these advances has been a huge increase in the computing power available for simulation-based design and optimization.

So we asked COMSOL, an innovator in multiphysics simulation software and the creator of this special supplement to lay out how the leap in computational capability has changed what simulation software can do today.

In the next few pages you will find examples of some truly remarkable work. These include developing metamaterials to achieve electromagnetic cloaking, the shaping of fractal-like pattern cold-plates to cool power-electronics in hybrid cars, and bringing superconducting fault current limiters to the power grid.

I am sure you will find this supplement, sponsored by COMSOL, fascinating.

Please feel free to contact me if you would like to share your own experiences in pushing the limits of simulation. ©

Email: jv.ieeemedia@ieee.org

CONTENTS

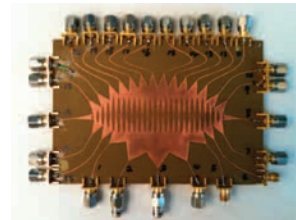

3 METAMATERIALS MAKE PHYSICS SEEM LIKE MAGIC

- NASA Glenn Research Center, Cleveland, OH USA
- Naval Postgraduate School, Monterey, CA USA
- Duke University, Center for Metamaterials and Integrated Plasmonics, Durham, NC USA

8 NUMERICAL SIMULATION-BASED TOPOLOGY OPTIMIZATION LEADS TO BETTER COOLING OF ELECTRONIC COMPONENTS IN TOYOTA HYBRID VEHICLES

- Toyota Research Institute of North America, Ann Arbor, MI USA

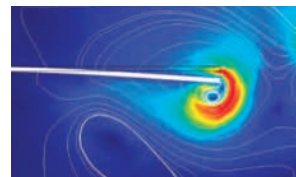

12 MODELING OPTIMIZES A PIEZOELECTRIC ENERGY HARVESTER USED IN CAR TIRES

- Siemens Corporate Technology, Munich, Germany

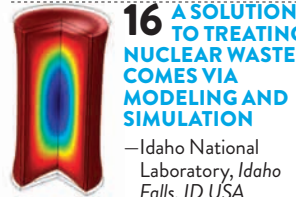

16 A SOLUTION TO TREATING NUCLEAR WASTE COMES VIA MODELING AND SIMULATION

- Idaho National Laboratory, Idaho Falls, ID USA



19 MODELING SCAR EFFECTS IN ELECTRICAL SPINAL CORD STIMULATION

- Lahey Clinic, Burlington, MA USA



22 UPGRADING THE NUTS AND BOLTS OF THE ELECTRICAL GRID FOR A NEW GENERATION

- ABB AB Corporate Research Power Technologies, Västerås, Sweden
- Florida State University, Center for Advanced Power Systems, Tallahassee, FL USA

26 NUMERICAL MODELING OF ELECTROSTATIC PRECIPITATORS

- Alstom Power Sweden AB, Växjö, Sweden



29 LIGHTNING-PROOF WIND TURBINES

- Global Lightning Protection Services A/S, Lejre, Denmark

32 MATHEMATICAL MODELING: AN INDUSTRIAL PERSPECTIVE

- DuPont Experimental Station, Wilmington, DE USA

ON THE COVER: Advanced heat sinks with optimized cooling channel topology are being designed to cool power electronic components in Toyota hybrid vehicles.

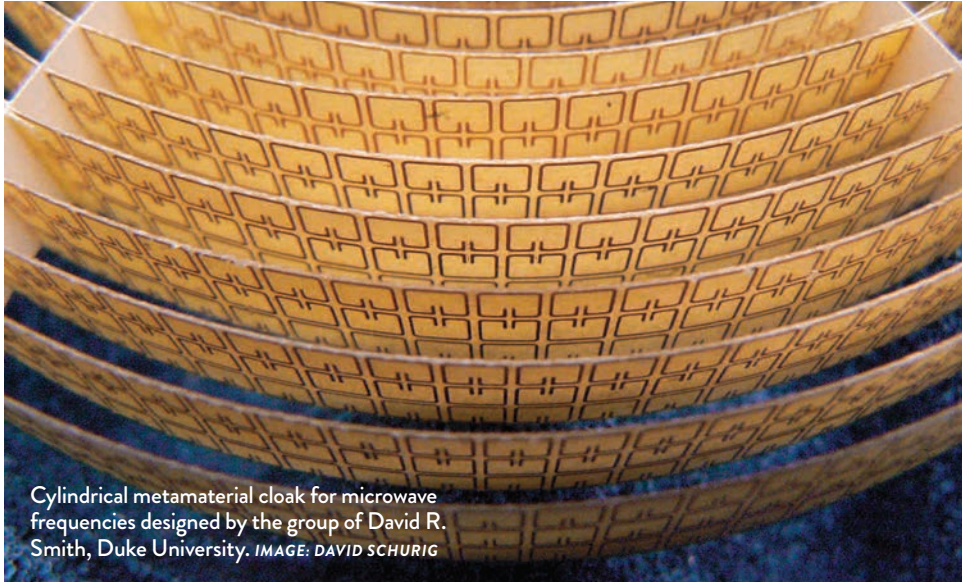

Cylindrical metamaterial cloak for microwave frequencies designed by the group of David R. Smith, Duke University. IMAGE: DAVID SCHURIG

METAMATERIALS MAKE PHYSICS SEEM LIKE MAGIC

To achieve this magical effect, one must have simultaneous control over multiple physical phenomena

By **DEXTER JOHNSON, PROGRAM DIRECTOR, CIENTIFICA & BLOGGER, IEEE SPECTRUM ONLINE**

THE FAMED SCIENCE fiction author Arthur C. Clarke once remarked, “Any sufficiently advanced technology is indistinguishable from magic.”

If this idea indeed holds true, then the emerging field of metamaterials would have to be classified as a “sufficiently advanced technology.” Metamaterials have been stunning both the layman and the scientist in recent years with their ability to render objects invisible (see the cloak image above), leaving many to comment only half in jest that they must be magic.

Metamaterials are not magic, however. Instead, they are the result of a science that requires an enormous amount of knowledge and control over electromagnetic phenomena and other physical attributes of materials.

A metamaterial can be broadly defined as an artificially structured material fabricated by assembling different objects so as to replace the atoms and molecules that one would see in a conventional material. The resulting material has very different electromagnetic properties

than those found in naturally occurring or chemically synthesized materials.

Manipulating the structure of the metamaterial allows it to interact with and control electromagnetic waves. Just what an impact this has comes into stark relief when we take into account the fact that electromagnetic radiation can have wavelengths that range from thousands of kilometers to billionths of a meter.

Controlling electromagnetic waves lets us control whether objects can be seen. For instance, the wavelength of the electromagnetic waves that make up visible light ranges from 400 to 750 nanometers. But because the spacing between atoms is much smaller than that—on the order of one-tenth of a nanometer (an angstrom)—we cannot resolve an image of atoms from visible light. This leads to the exciting prospect of using metamaterials to make invisible objects visible and visible objects invisible.

All the fine details of the medium are blurred on the spatial scale of about one wavelength, which allows physicists to use an averaged description known as effective medium theory. The idea of metamaterials stems from this simple concept of field averaging.

The many orders of magnitude difference between the wavelength of visible, infrared, or microwave radiation and the atomic



David R. Smith (above), Yaroslav Urzhumov, Duke University.

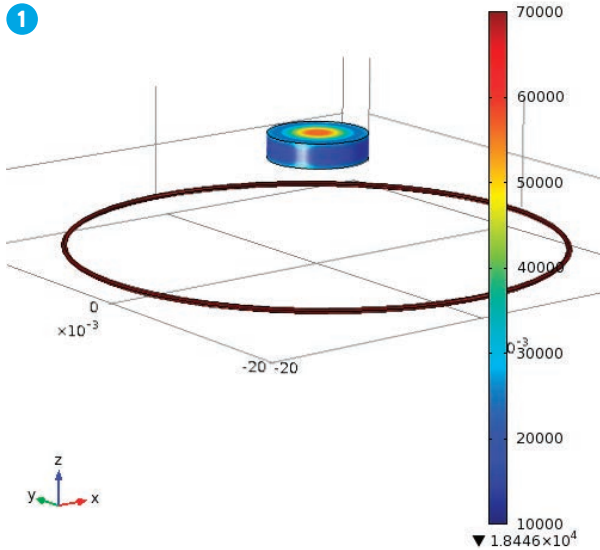

FIGURE 1: Full-wave simulation of a magnetic metamaterial disk levitating above a current-carrying coil.

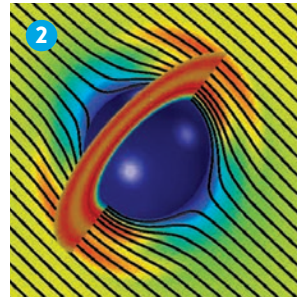

FIGURE 2: Hydrodynamical cloak: a porous metamaterial shell that eliminates wake. Designed and modeled with COMSOL Subsurface Flow and Optimization Modules.

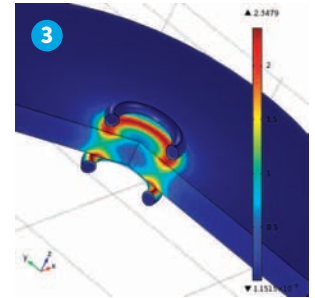

FIGURE 3: A pair of coils tightly coupled through a negative-permeability metamaterial slab.

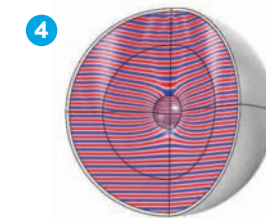

FIGURE 4: Unidirectional acoustic cloak based on quasi-conformal transformation optics, modeled using COMSOL's axisymmetric pressure acoustics.

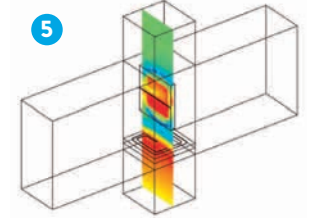

FIGURE 5: A composite Split Ring Resonator Thin Wire Array metamaterial exhibiting negative index of refraction in the microwave X-band; COMSOL simulation. Note the additional blocks of free space that facilitate multi-directional S-parameter simulations.

IMAGES: YAROSLAV URZHUMOV (DUKE UNIVERSITY)

scale creates a window of opportunity for an effective medium consisting of artificial “atoms” that are much larger than real atoms but still significantly smaller than the wavelength of the radiation. Such a medium is what scientists call a metamaterial.

» **NEGATIVE REFRACTIVE INDEX**

AN IMPORTANT PROPERTY of metamaterials is the phenomenon of negative refraction. Of course, we’re all aware from an early age that refraction is the bending of light at the intersection of two materials.

The most common example of refraction at work is the observation of underwater objects from above the water. In this case, refraction makes those objects appear closer to the surface than they actually are. So refraction provides the basic

optical principle for the manufacturing of lenses or any other optical device that bends or manipulates light.

All materials in nature have a refractive index, or a measurement of the speed of light through that material. But some metamaterials are capable of achieving what is known as a negative refractive index, resulting in metamaterials’ sometimes being referred to as “left-handed” or “negative-index” materials.

A material that has a negative refractive index is capable of bending light in the opposite direction of what we would expect based on typical refraction.

The method by which you make a material that has a negative refraction index requires reversing the electrical component (permittivity) and the magnetic component (permeability) of a material’s refractive index. This is accomplished by artificially constructing a material (Figure 5) that

possesses structures with dimensions smaller than the wavelengths of the light it is intended to refract. This causes the atoms and the photons in the material to resonate and reverse the material’s permittivity and permeability.

These optical capabilities of metamaterials are important for understanding the wide array of applications that exist for them.

» **APPLICATIONS FOR METAMATERIALS**

ONE OF THE first potential applications suggested for metamaterials was a “superlens” that would utilize the negative refraction of a metamaterial to provide much higher resolution than is possible with lenses made from natural materials, according to Jeffrey D. Wilson, a physicist at NASA’s Glenn Research Center.

Such a lens could enable very high-resolution imaging and lithography, with

one application being the fabrication of smaller and faster computer chips. Problems with fabrication and attenuation issues need to be solved, however, before this becomes practical. Attenuation issues that severely limit the performance of negative-index lenses are however less severe in near-field applications, where, instead of negative index, one can use either a negative permittivity or negative permeability. The latter material property - still rarely available in nature - is particularly promising for applications requiring magnetic field enhancement and focusing, such as magnetic levitation (Figures 1, 3).

“The area in which electromagnetic metamaterials have first been used for practical application is antenna technology,” explains NASA’s Wilson. “Metamaterials have been used in antennas to significantly reduce size, increase frequency bandwidth, and increase gain.”

While antenna technology has been the largest application for metamaterials, it is perhaps in the area of “cloaking” that the most excitement and publicity have been generated.

In cloaking, metamaterials are used to divert microwaves or optical waves around an object so that it appears invisible. Most of the applications for this cloaking effect involve the military.

Among the exciting potential future applications being discussed for

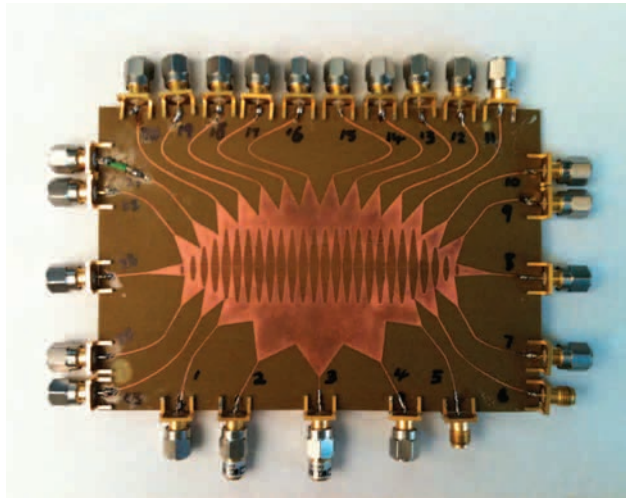

MICROWAVE DEVICE: Microwave Rotman lens whose size is substantially reduced with the aid of magnetic metamaterial filling the tapered transmission lines in the center. IMAGE: JOHN HUNT (DUKE UNIVERSITY)

metamaterials is a seismic metamaterial that could be used to protect structures from earthquakes, according to Wilson.

Another area in which metamaterials are gaining traction is in terahertz (THz) technologies, in particular for imaging applications. THz imaging has aroused interest in the contexts of security and medical imaging because of its ability to penetrate non-metallic materials and fabrics and do so without damaging tissue or DNA.

“THz waves have frequencies that are higher than those of microwaves but lower than those of optical radiation,” explains Wilson. “However, the THz frequency band has been essentially neglected and is referred to as the ‘THz gap’ of the electromagnetic spectrum. The primary reason for this is that currently available compact THz sources can produce only

small amounts of power—on the order of milliwatts.”

Some companies have developed airport scanners that make use of THz imaging but achieve their capabilities by means of very expensive and complicated imaging arrangements.

The problem has been that the background thermal energy in the THz range of the electromagnetic spectrum is small compared with infrared, according to Fabio Alves, a researcher from the Sensor Research Lab, led by Professor Gamani Karunasiri, at the Naval Postgraduate School (NPS) in Monterey, Calif. When the THz waves have to travel through open air, as they do in airport imaging technologies, most of the radiation is absorbed before it reaches its target.

Alves and his colleagues

at NPS have been developing metafilms (thin films based on metamaterials) that could enable less expensive THz imaging devices and total absorption of the THz waves.

“The metafilm we are developing exhibits properties not found in natural materials,” explains Alves. “It is obtained by placing a periodic array of metal cells close to a conducting plane in between to form an artificial structure that exhibits electromagnetic properties such that its impedance matches with the surrounding media (free space in our case) at a specific frequency.

“In this situation, ideally there is no transmission and no reflection, resulting in total absorption. By selecting appropriate materials and geometry, it is possible to design films with near 100 percent absorption in the desired frequency.

“Simulation tools enable us to be creative and to quickly test new ideas that would be much more difficult, time-consuming, and expensive to test in the lab.”

—JEFFREY D. WILSON,
NASA GLENN
RESEARCH CENTER

The films can be employed in the fabrication of microbolometers and bimaternal focal plane arrays, where the absorption characteristic can be engineered to match the frequency of the source, significantly improving the efficiency of the imaging system.”

One of the leading research organizations in metamaterials—and the one perhaps most closely associated with the cloaking effects of metamaterials—is the Center for Metamaterials and Integrated Plasmonics (CMIP) at Duke University, led by David R. Smith. CMIP is also working on finding ways of compensating near-field decay in free space or open air.

In ongoing work at CMIP, Yaroslav Urzhumov, an assistant research professor, and others are working with Toyota Corporation to fabricate magnetic metamaterials

“As for me personally, I discovered entirely in a COMSOL simulation that these cloaks can perform extremely well in the short-wavelength limit.”

—YAROSLAV URZHUMOV,
DUKE UNIVERSITY

for wireless power transfer for electrical vehicles (EVs).

When one imagines how such a wireless transfer of power could be achieved, one usually conjures up devices incorporating microwave or laser technology. Both of these technologies come with the obvious inherent risk of frying the device being charged, however.

Just as Smith and his CMIP colleagues developed metamaterials that made it appear as though an object had disappeared using electromagnetic cloaking, they have now created a lens (Figure 3) made from metamaterials that can focus low-frequency fields in such a way that it makes the distance between the power source and the device being charged disappear.

Making a source appear closer than it really is with the aid of metamaterial-based lenses is just one of the tricks that the novel concept of transformation optics has predicted. Transformation optics is an engineering methodology based on the idea of warping, bending, or squeezing physical space, as electromagnetic waves or fields see it. While cloaks and flattened fish-eye lenses (see the Maxwell fish-eye lens above) are examples of space warping, even more trivial coordinate transformations like space squeezing are of tremendous practical use, as they reduce the device

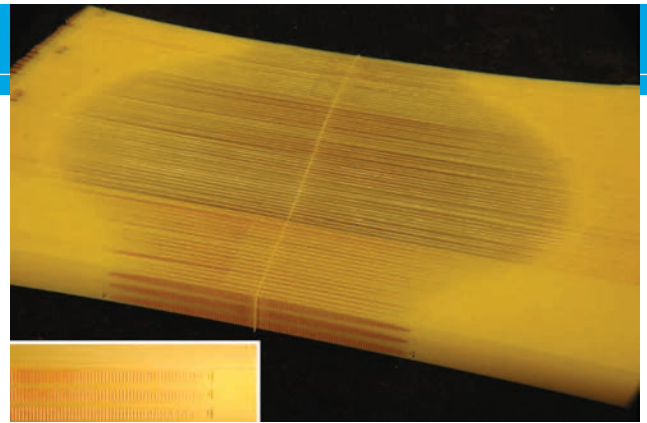

A modified Maxwell fish-eye lens with two flattened surfaces for two-dimensional microwave propagation, experimental sample. The flattening of a normally circular Maxwell lens shape is accomplished with quasi-conformal transformation optics theory. IMAGE: JOHN HUNT (DUKE UNIVERSITY)

dimensions without deteriorating its performance (See the compressed Rotman lens on the previous page.). Physical implementations of space transformation ideas almost invariably require metamaterials with exotic electromagnetic properties.

» OBSTACLES IN DESIGNING WITH METAMATERIALS

ONE OF THE key design constraints researchers face when working with metamaterials is the high ohmic loss of metamaterials due to the ohmic losses in the metal. This causes electromagnetic waves that pass through the structure to be strongly attenuated.

Not only are there design constraints in working with metamaterials, but they also require a high level of control over their structure. In fact, a metamaterial derives its properties—such as its electromagnetic cloaking—from its structure rather than its chemical composition. So, as one might imagine, being able to design and then fabricate these complex structures is no easy feat.

“Metamaterials usually have a fairly complex structure, with a large number of design parameters,

including architectural parameters as well as electromagnetic properties of the materials from which they are constructed,” explains CMIP’s Urzhumov.

“Complex structure leads to very complex electromagnetic response. Frequency spectra of metamaterials typically have lots of interesting features, most stemming from electric and magnetic resonances,” says Urzhumov.

While analytical models exist for a handful of simple geometries and crude semi-analytical estimates can be made for certain other types of structures by introducing approximations, it is virtually impossible to predict the electromagnetic response of complex structures without simulations, according to Urzhumov.

The impact of modeling and simulation tools in the field of metamaterials is not restricted to the science. It can also extend to business considerations, as well as helping to push the limits of our imagination.

“Simulation tools enable us to be creative and to quickly test new ideas that would be much more difficult, time-consuming, and expensive to test in the lab,”

explains NASA's Wilson. "When we find an idea that works, we can optimize the desired effect and thus specify the design to be built."

But ultimately, science considerations are paramount when working with metamaterials. If one wants metamaterial-based devices to function properly, precise knowledge of the response at each frequency of interest is needed, making accurate frequency-domain simulations a requirement.

It's become clear that simulation is absolutely necessary in working with structures that have arbitrary, inhomogeneous, time-dependent, and nonlinear electromagnetic properties, as seen in metamaterials. But not all simulation tools have these capabilities—and if they do, they're quite limited.

According to NPS's Alves, modeling and simulation tools have been exceptionally helpful in the design and analysis of the metafilms he and his colleagues are developing.

"One of the most significant design constraints in our work is the lack of an analytical model that completely explains the interactions of all involved parameters," explains Alves. "The numerical simulations fill this gap. The flexibility of COMSOL Multiphysics allows us to deal with several degrees of freedom simultaneously. Furthermore, material properties can be tuned by fitting the measured and simulated data, improving the accu-

racy of future designs."

Flexibility and versatility are key requirements for a modeling and simulation tool when working with metamaterials.

"The use of COMSOL Multiphysics allows us to analyze the performance of the sensors in many ways," (Figure 6) says Alves. "In the specific case of the bimaterial sensor, RF simulations were conducted to obtain the amount of radiated power absorbed by the metafilms. This power is converted into heat that flows through the sensor and is exchanged with the environment. This phenomenon can be studied using heat transfer simulations."

Ultimately, structural mechanics simulations evaluate the deformation in the bimaterial structures, which is the effect to be probed by the external readout, according to Alves. This is all done in a single run.

"This process would be exceedingly difficult without the help of multiphysics simulations," says Alves.

"We appreciate the versatility of all boundary conditions and excitation types that can be used in all types of studies in COMSOL," says Urzhumov. "One feature in particular—the ability to specify a given background field and use it as an excitation—has been truly enabling for many of our projects."

COMSOL Multiphysics can do much more than just modify all boundary conditions: It allows for changes to the equations themselves.

"I routinely insert addi-

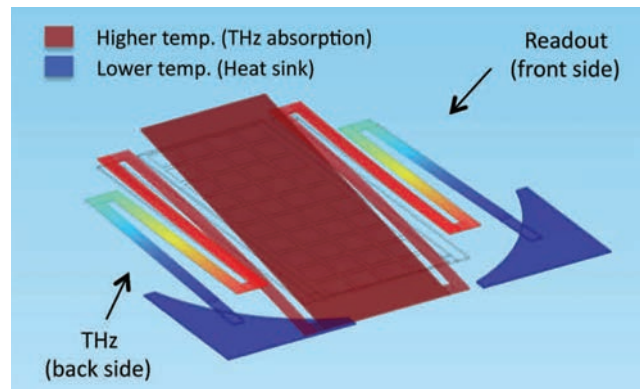

FIGURE 6: COMSOL simulation (deformation analysis) of the Bi-material sensor integrated with the THz sensitive metafilm. The metafilm in the center absorbs THz and transfer the heat to the multifold legs that bend proportionally to the absorbed radiation. The amount of bending can be accessed using optical readouts.

IMAGE: FABIO ALVES (NAVAL POSTGRADUATE SCHOOL (NPS))

tional polarization densities that describe the response of a dispersive medium, such as a metal at optical frequencies, which allows me to model negative-index metamaterials in the time domain," says Urzhumov. "This extra polarization density is merely an extra term in the main electromagnetics equation that couples it to an extra equation describing the evolution of that polarization density."

In fact, the most noted quality of metamaterials, their ability to cloak objects electromagnetically—the so-called "invisibility" cloak—was predicted entirely by simulation, according to Urzhumov.

"As for me personally, I discovered entirely in a COMSOL simulation that these cloaks can perform extremely well in the short-wavelength limit," says Urzhumov.

» DISCOVERIES AND APPLICATIONS ENABLED BY MODELING AND SIMULATION

URZHUMOV CREDITS

much of the success of his research to being able to use modeling and simulation tools to open up new avenues of discovery.

According to Urzhumov, one of unique features of COMSOL is its ability to perform a sensitivity analysis semi-analytically, which enables quick gradient-based optimization with a huge number of design parameters.

"With the help of the numerical optimization in COMSOL I could extend my 'fluid cloak' solution (Figure 2) into the strongly nonlinear flow regime, where analytical solutions are almost impossible to obtain," says Urzhumov. ©



The Toyota Research Institute of North America's topology optimization team includes (from left) Ercan Dede Ph.D., principal scientist; Jaewook Lee Ph.D., researcher; and Tsuyoshi Nomura Ph.D., senior principal engineer.

NUMERICAL SIMULATION-BASED TOPOLOGY OPTIMIZATION LEADS TO BETTER COOLING OF ELECTRONIC COMPONENTS IN TOYOTA HYBRID VEHICLES

By **GARY DAGASTINE**

ONE GLANCE UNDER the hood of a modern automobile is all it takes to realize that free space in the engine compartment is a thing of the past.

If carmakers could reduce the number, size, and weight of the components in there, better fuel economy would result. A case in point is the design and development of optimized cooling structures, or advanced heat sinks, for thermally regulating the growing number of power electronics components used in the electrical system of Toyota hybrid vehicles.

To save the time and expense associated with analytical design methods and trial-and-error physical prototyping, researchers at the Toyota Research Institute of North America (TRI-NA) in Ann Arbor, Mich., instead used numerical simulation and multiphysics topology optimization techniques to design, fabricate, and test possible prototypes of a novel heat sink for future hybrid vehicle generations.

One prototype example combines single-phase jet impingement cooling in the plate's center region with integral hierarchical branching cooling channels to cool the periphery. The channels radiate from the device's center, where a single jet impinges, and carry liquid coolant across the plate to dissipate heat evenly throughout, with minimal pressure loss.

Numerical simulations enabled Dr. Ercan (Eric) Dede, principal scientist in TRI-NA's Electronics Research Department, and his colleagues to produce the optimized branching cooling channel patterns in an automated fashion, using advanced simula-

tion tools as opposed to a traditional trial-and-error design approach.

Dede carried out this work as part of TRI-NA's mission to conduct accelerated advanced research in the areas of energy and environment, safety, and mobility infrastructure. TRI-NA is a division of the Toyota Technical Center, which in turn is part of Toyota Motor Engineering & Manufacturing North America, in charge of R&D, engineering design and development, and manufacturing activities for Toyota's North American plants.

TRI-NA's Electronics Research Department focuses on two main areas: 1) sensors and actuators and 2) power electronics. Among its resources are powerful modeling and simulation capabilities and prototype design tools, which enable its staff to develop effective solutions in the compressed time frames demanded by the highly competitive automotive markets.

» HOT UNDER THE HOOD

TOYOTA HYBRID vehicles have sophisticated electrical systems in which many power diodes and power semiconductors, such as

insulated gate bipolar transistors (IGBTs), are used for power conversion and other applications. These components are standard planar silicon devices measuring a few centimeters per side, with high power dissipation.

In these hybrid vehicles, they are mounted on aluminum heat sinks, or cold plates, through which a water-glycol coolant mixture is pumped. In earlier model years, the cold plate design featured a fluid inlet on one side of the plate and an outlet on the other side; in between were arrangements of mostly straight cooling channels through which the coolant flowed. The long channels provided adequate heat transfer, but it came at the cost of a significant pressure drop across the plate.

The technology roadmap for these power components, however, calls for them to shrink to about half their current size while dissipating the same amount of power, meaning that heat fluxes will have to increase. In addition, although they have a 150 °C maximum operating temperature, silicon devices are normally kept at lower temperatures for greater component reliability. Furthermore, the role of such devices is becoming more important as the electrification of vehicle systems increases.

All of these factors mean that the thermal management of these devices will become more difficult

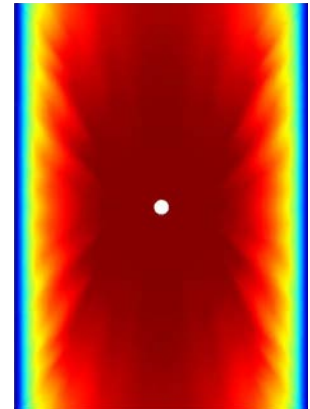
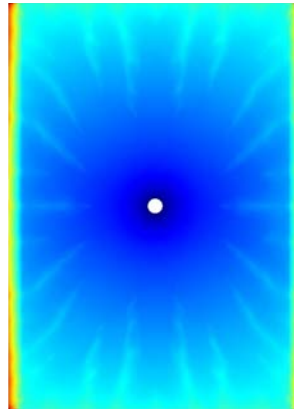
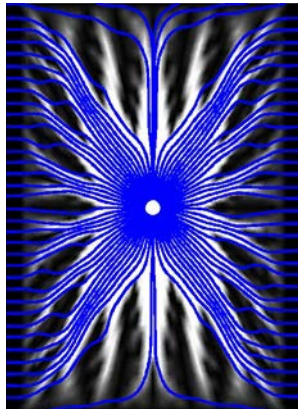

FIGURE 1: Optimal cooling channel topology, with fluid streamlines colored blue (left), normalized temperature contours (center), and normalized pressure contours (right).

than it has been to date.

It might seem reasonable simply to redesign the cold plates so that more coolant can be pumped through them. But that would require more pumping power, and with space already at a premium in the engine compartment where the pump is located, moving to a larger, more powerful pump or adding an additional pump is unacceptable.

Instead, Toyota decided to look at re-engineering the cold plate with an eye toward achieving optimum heat transfer along with negligible additional pressure drop. If both could be achieved, thermal objectives could be met with no need to significantly increase system pumping capacity.

» JET IMPINGEMENT AN INCOMPLETE SOLUTION

“MANY RESEARCHERS working on diverse applications have identified jet impingement as an attractive way to cool surfaces,” says Dede.

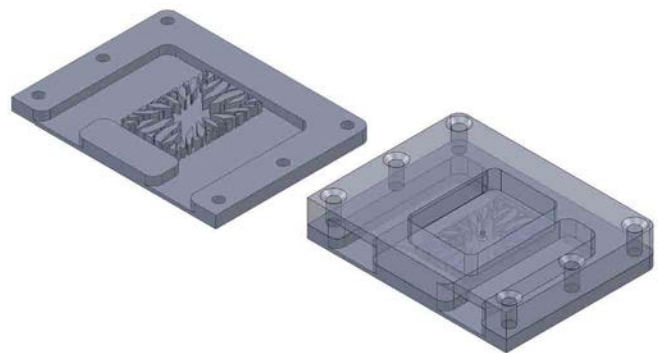

FIGURE 2: Isometric views of the derived hierarchical micro-channel cold plate, without a jet plate (left) and with a jet plate, which is shown transparent for clarity (right).

“But while jet impingement performs well with respect to heat dissipation close to the jet, it’s less than optimal as you move away from the orifice.”

The reason is that the greatest heat transfer occurs close to the jet entrance, where the fluid is the coolest and velocity is the highest. As a result, much heat-transfer capability is lost by the time the coolant reaches the exit of the cold plate.

One solution to this problem is to combine jet

impingement with a peripheral channel structure to increase the area-average heat transfer. “It’s in your interest to make those channels short to keep pressure drop to a minimum, but short, straight channels aren’t efficient enough for our needs,” Dede explains. “Our goal was to come up with a combination jet impingement/channel flow-based cold plate with optimally designed branching channels to uniformly remove the

least pressure drop.”

The CFD and Heat Transfer Modules of COMSOL Multiphysics software were essential to the numerical simulations at the heart of this work. COMSOL's LiveLink™ for MATLAB® also enabled Dede to work with the multiphysics simulations in a high-level scripting language as he went about the task of optimizing the cold plate's topology.

He examined how topology influenced such variables as steady-state convection-diffusion heat transfer and fluid flow. He did this using well-established material interpolation techniques and a method of moving asymptotes (MMA) optimizer, moving back and forth between COMSOL and MATLAB in an iterative fashion to investigate cooling channel layouts. (MMA is a convex-approximation strategy to aid in optimizing physical structures.)

Although the aspect ratio of the channels (i.e., the ratio of height to width) is quite important, to simplify the numerical simulations Dede assumed a thin 3-D structure and then further “flattened” it. Once an initial channel topology was derived, the height of the fins that separate the cooling channels could be investigated and incorporated with a separate parametric sizing study. Dede's group had separately performed such

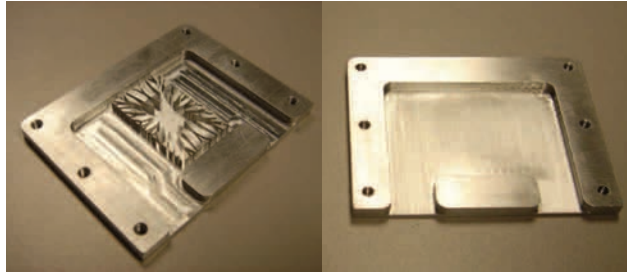

FIGURE 3: Prototype aluminum cold plates with (left) and without (right) the hierarchical microchannel topology.

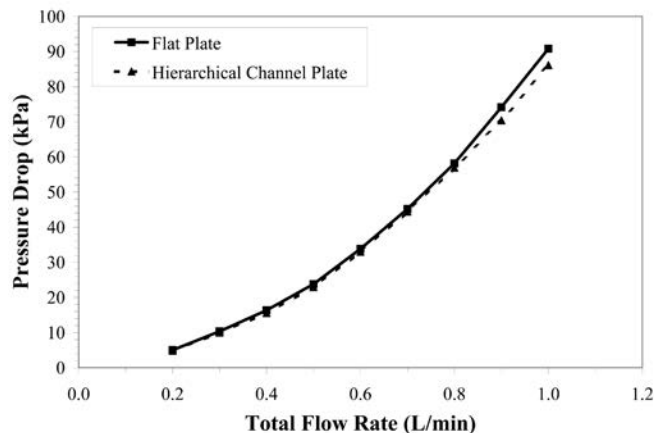
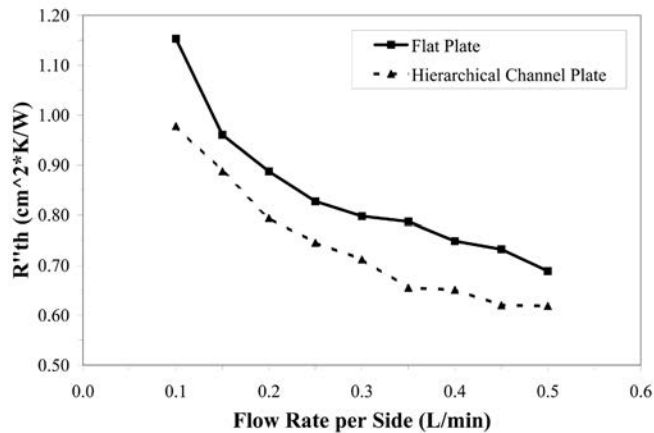

FIGURE 4: Comparison of cold plate unit thermal resistance (top) and pressure drop (bottom).

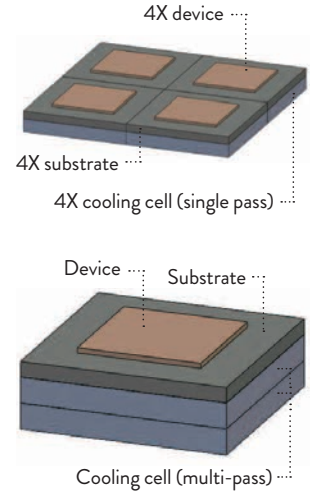

FIGURE 5: Multichip application (left) and multipass configuration for single-chip package.

studies, so his assumptions were well informed.

Ultimately, these numeric simulations produced an optimal cooling channel topology with fluid streamlines in branching channels (see Figure 1).

Because these channels efficiently distribute coolant throughout the plate and create relatively uniform temperature and pressure distributions that are a function of branching complexity, this fractal-like topology was in turn used to guide the design of a cold plate prototype (see Figure 2). The size of the plate was set to approximately 60 by 45 millimeters, with a middle cooling zone covering a 25- by 15-mm area to match a specific heat source. The plate's base substrate thickness was assumed to be 1 mm.

» REAL-WORLD PERFORMANCE

“ONCE WE USED COMSOL and MATLAB for the topology optimization routine, we then used the final channel concept from it to design and evaluate a prototype using COMSOL’s LiveLink™ for SolidWorks®,” Dede says. “COMSOL has a nice feature that allows you to actively link to computer-aided design tools, and it was easy to import various structures from SolidWorks back into COMSOL to verify pressure drop and heat transfer.

“I think this is really the future of simulation, to be able to link your CAD tool to your simulation tool so that you can streamline the development of fast, accurate design iterations,” Dede added. “It’s not necessarily going to solve all of your problems, but it helps you to quickly establish a reasonable starting point and to make fast progress from there.”

Using the SolidWorks designs, two prototypes were fabricated from aluminum, using standard micromachining techniques. Two prototypes were produced so that unit thermal resistance and pressure drop in a combined jet/hierarchical microchannel version could be compared against a version that utilized jet impingement of a simple flat plate (see Figure 3).

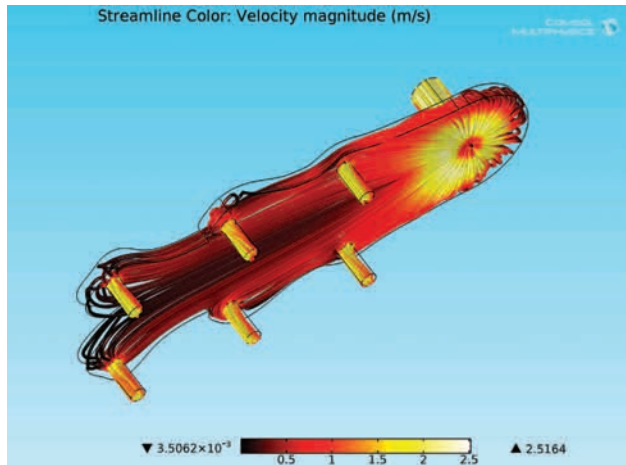

FIGURE 6: Manifold to feed fluid to multiple multipass cooling cells.

The prototypes were then incorporated into a double-sided cooling test setup to see whether a dual configuration might provide higher-performance cooling in an ultra compact package size.

On average, the dual hierarchical microchannel version dissipated 12.8 percent more power than the flat-plate version (see Figure 4, top). Indeed, using water as the coolant, it demonstrated very high heat transfer when cooling on both sides of the heat source was accounted for. With regard to pressure drop, both cold plates demonstrated similar results, although the dual hierarchical version performed slightly better at higher flow rates (see Figure 4, bottom).

» FUTURE DIRECTIONS

DEDE NOTED THAT the cold plate concept could be applied to multichip packages or could even be used

in a multipass configuration for a single-chip package for higher-performance cooling (see Figure 5).

Along these lines, Dede performed other numerical topology optimization simulations to study the fluid flow of a cold plate inlet manifold made up of a single fluid inlet and six outlets. Such a manifold could feed fluid to multiple multipass cooling cells. In Figure 6, the fluid streamlines are colored according to their velocity magnitudes. The curvy sidewall manifold shape was generated through fluid-flow topology optimization studies, where the goal was to minimize the pressure drop across the manifold while balancing the flow rate to each outlet nozzle.

The flow rates across all nozzles are within 7 percent of each other, and the pressure drop is about 2 kilopascals, mean-

ing that the different local sections of the cold plate would receive the same coolant flow. This results in an even balance of the device’s temperature distribution across the cold plate.

“The work we’ve done here is really just the first iteration of this solution,” Dede says. “In the future, we will also look at such things as manifold design to decrease the pumping penalty further. Also, we may be able to optimize the topology of each individual cooling cell so that it works optimally in a 3-D configuration.”

And what about even farther down the road? “We can apply these methods to other things, like electromagnetics and thermal stresses, as well,” Dede says. “We believe this project is just the beginning for numerical-simulation-based topology optimization.” ©

For more information, see the paper “Experimental Investigation of the Thermal Performance of a Manifold Hierarchical Microchannel Cold Plate,” by Toyota’s Ercan M. Dede in the InterPack 2011 Conference Proceedings (from the ASME 2011 Pacific Rim Technical Conference & Exposition on Packaging and Integration of Electronic and Photonic Systems).

MODELING OPTIMIZES A PIEZOELECTRIC ENERGY HARVESTER USED IN CAR TIRES

Siemens is using fluid-structure interaction simulation to ensure the cost effective optimization of a cantilever in a MEMS generator designed to power a tire pressure monitoring system.

By **JENNIFER HAND**

THE DESIRE TO eliminate batteries and power lines is motivating a wide range of research. In the quest for systems that are energy autonomous, the concept of energy harvesting is attracting a great deal of attention. Combine this idea with operation at the micro level, and the “what if” scenarios become even more enticing.

For researchers at Siemens Corporate Technology in Munich, exploring the potential of an energy-harvesting microelectromechanical system (MEMS) generator holds strong appeal. As Ingo Kuehne, a senior engineer explains, “Our mandate is broad. We are looking to develop platform technologies for tomorrow rather than specific products;

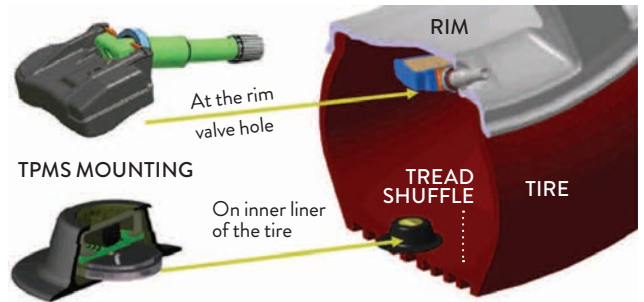

FIGURE 1: Two TPMS mounting options: on the rim or on the inner lining of the tire.

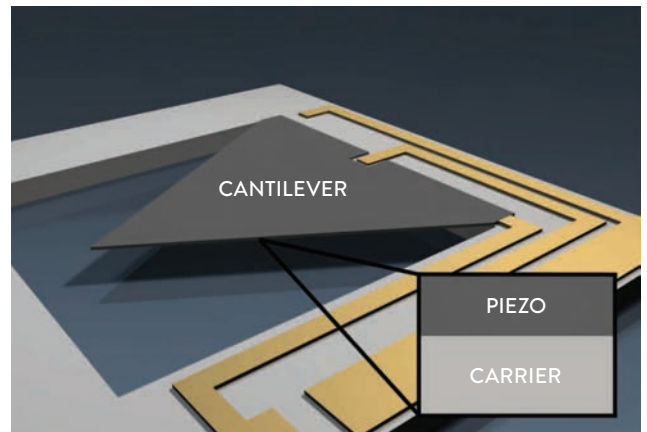

FIGURE 2: Schematic of the piezoelectric MEMS generator energy harvester. The cantilever is made of two materials, and electrical energy is transferred through the circuit from the cantilever.

however, it makes sense to demonstrate the value of our research. Together with our partner Continental AG, we decided to focus on an application with clear commercial potential. Our ultimate goal is to design the MEMS generator to be as small, light, and strong as possible, with enough energy to power a system under a range of conditions.” The researchers chose to design a microgenerator for an innovative tire pressure monitoring system

(TPMS) driven by motion.

TPMSs are traditionally powered by batteries, they tend to be mounted on the wheel rim. With no reliance on a battery, such a system could be placed inside the tire (see Figure 1) and would be in a position to measure much more than pressure. It could monitor temperature, friction, wear, and torque; assist with optimal tracking and engine control; and convey all this critical infor-

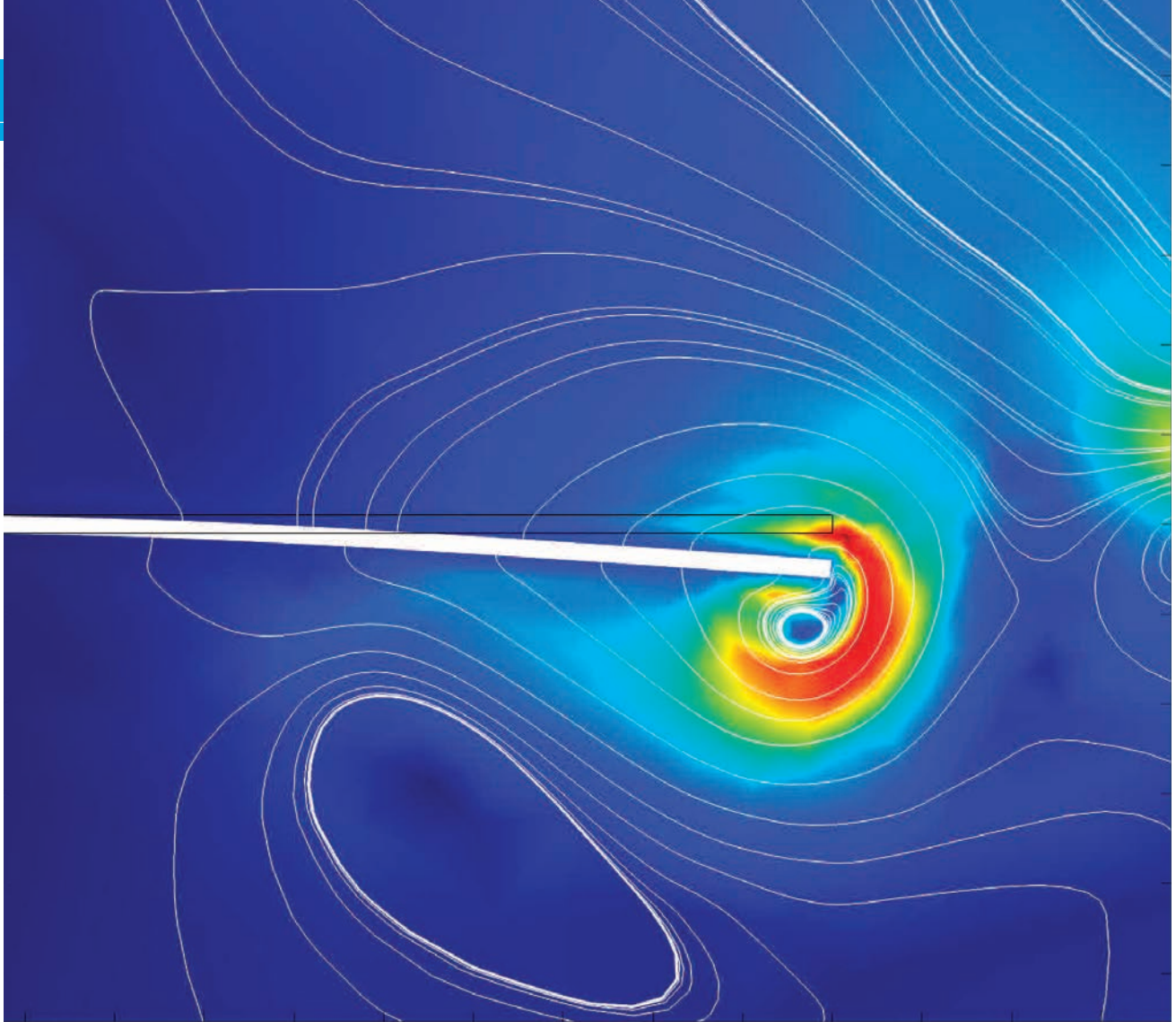

FIGURE 3: A 2-D FSI simulation showing the velocity field caused by feeding mechanical cantilever energy into the disordered kinetic energy of the surrounding gas.

mation wirelessly. It would also be maintenance-free, low in cost, and environmentally friendly.

Yet locating the device within the tire requires that the assembly be extremely robust and able to withstand gravitational accelerations up to 2500 g. Moreover, to avoid tire imbalance it would have to be very light, and in terms of operational life it would need to match that of a tire—a minimum of eight years.

» **FROM MECHANICAL STRESS INTO ELECTRICAL ENERGY**

MOUNTED TO ONE spot on the inside of a tire, a piezoelectric microgenerator would be able to harvest energy from the compression created each time that particular area of the tire touched the ground. The cantilever was designed to incorporate a thin film of self-polarized piezoelectric ceramic material with a silicon carrier layer, which provides

mechanical stability and stores harvested mechanical energy (see Figure 2).

The team settled on a triangular design for the spring-loaded piezoelectric cantilever, as such a shape enables a uniform stress distribution in the surface direction. “Typical cantilever designs have substantial mass and are heavy, with a concentrated weight at the tip. This is fine for the conventional method of continuously exciting a cantilever at its natural frequency. However, the high dynamic forces we are dealing with prevent us from using this method of

“ *In that amount of time it is easy to simulate the performance of up to 2,000 different prototypes within COMSOL Multiphysics.*

—INGO KUEHNE

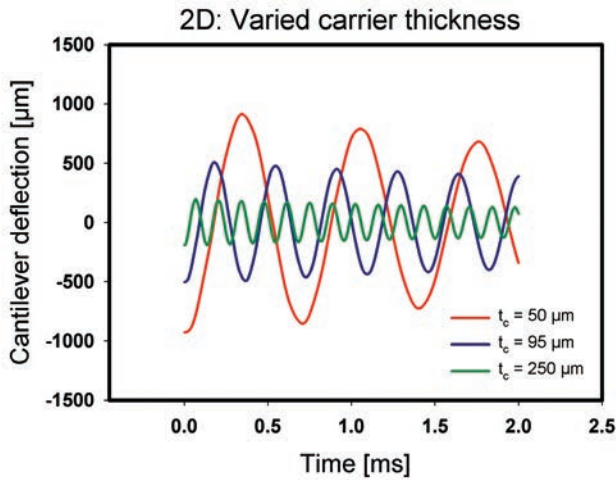

FIGURE 4: 2-D simulations of FSI on a cantilever's deflection at a gas pressure of 1 bar for various carrier thicknesses.

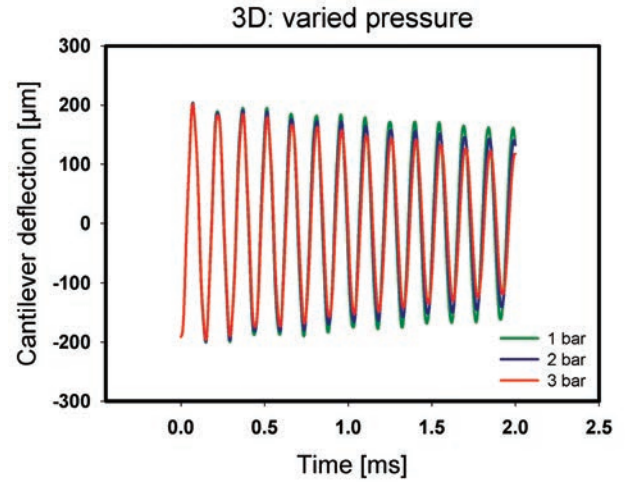

FIGURE 5: 3-D simulations of FSI on a cantilever's deflection as a function of gas pressure, with a carrier thickness of $250 \mu\text{m}$.

excitation," says Alexander Frey, a senior engineer. "We had to adopt an unconventional approach and avoid mass and its concentration. This in turn gave us a more serious problem, because damping becomes much more critical."

The big question for the Siemens team was how to optimize the design of the cantilever in order to minimize damping. It appeared that air damping was the dominant effect, and the aerodynamic profile was a critical parameter. Although the cantilever area was limited to 100 square millimeters, the layer thicknesses were design parameters that could be freely changed. "We needed to find suitable values for these parameters so that we could ensure that the mechanical oscillation would continue for

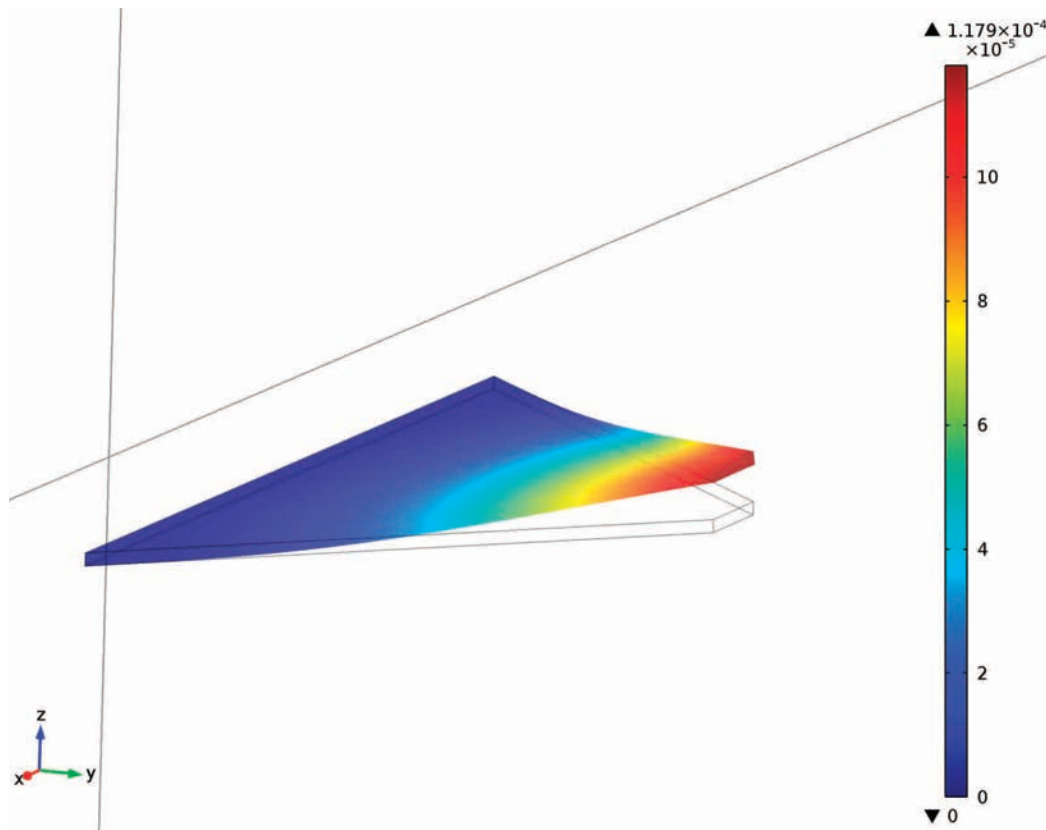

FIGURE 6: A 3-D FSI simulation showing the deflection of the triangular cantilever.

as long as possible and transfer as much of the mechanical energy as possible to the electrical domain,” says Frey. “We really needed a numerical tool to determine the optimal structure and ensure that enough energy was being produced.”

» FLUID AND STRUCTURE: AN OPEN RELATIONSHIP

HAVING IDENTIFIED THE transfer of mechanical energy to the surrounding air as a critical process, the team first conducted a fluid-structure interaction (FSI) analysis of the cantilever. Kuehne explains: “We started with static simulations, and these gave us some initial values. Then a time-dependent analysis allowed us to see a range of physical effects and understand the impact of the surrounding air on the damping of the cantilever.” (See Figures 3 and 4.)

Members of the team went on to conduct a 3-D FSI simulation and to consider the cantilever deflection as a function of external pressure and carrier thickness (see Figures 5 and 6). They examined the

maximum stress required for initial deflection at each thickness. With this analysis, Frey says, “we confirmed quantitatively that increasing the thickness of the cantilever led to an improvement in the damping behavior of the MEMS harvester.”

» OPTIMIZING THE CANTILEVER'S SIZE AND SHAPE

“WITH COMSOL Multiphysics simulation software, we learned how to numerically describe the behavior of our structure, which allowed us to conduct research in the laboratory,” says Kuehne. In order to compare the simulated behavior with experiments, the cantilever was periodically excited, and the piezoelectric voltage generated was recorded.

“Comparison of the simulation with physical testing revealed that the overall damping behavior was actually higher,” says Kuehne. “The obvious explanation was that we were losing energy because of intrinsic losses in the material. We assumed an accepted value for this internal damping, and

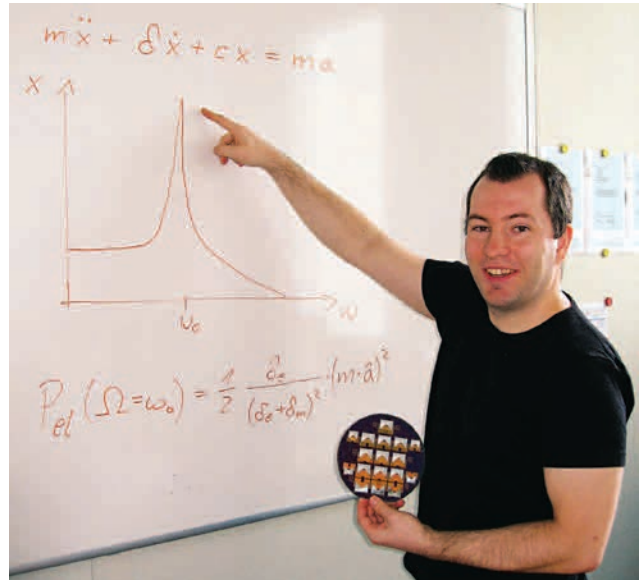

Kuehne holding one of the wafers used in the production of the MEMS energy harvester prototypes.

after taking these correction factors into account, we arrived at the same results. This reassured us that our simulation process with COMSOL was reliable and that we could continue to investigate the performance of the cantilever using different parameter values.” The team was then able to move on to optimizing system components and system integration (see Figure 7).

The use of COMSOL was critical to the development of the physical prototypes. According to Kuehne, it takes three people four months to do one technological run, which typically consists of one batch of up to 25 wafers. “One run usually results in a couple of complete prototypes, depending on lay-

out. Testing takes a further two months. In particular, the extra expense of a clean room infrastructure results in development costs of more than €100,000 for a single prototype run over six months. In contrast, you can measure a 2-D simulation in hours and a 3-D simulation in days. In that amount of time it is easy to simulate the performance of up to 2,000 different prototypes within COMSOL Multiphysics.”

Frey concludes: “Without COMSOL and the option of numerical modeling, we would have to make numerous physical structures, which would have been time-consuming and expensive. Instead, we were able to get on with the process of optimizing the MEMS design.” ©

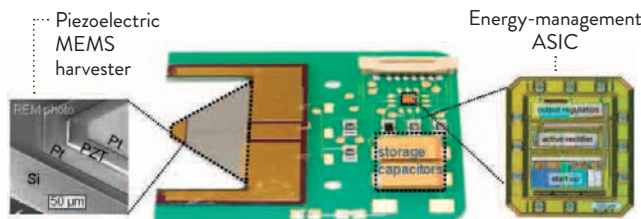

FIGURE 7: Prototype of a piezoelectric MEMS energy-harvesting module and the surrounding system.

A SOLUTION TO TREATING NUCLEAR WASTE COMES VIA MODELING AND SIMULATION

Simulations enable nuclear waste solution to come faster and cheaper than expected

By **DEXTER JOHNSON**, PROGRAM DIRECTOR, CIENTIFICA & BLOGGER, IEEE SPECTRUM ONLINE

THE IDAHO NATIONAL Laboratory (INL), owned by the U.S. Department of Energy (DOE), has been engaged since 1992 in the Idaho Cleanup Project (ICP) to clean up and dispose of radioactive material stored at the site. The ICP is the result of the INL having received spent nuclear fuels from reactors all over the world starting in 1952. From 1953 to 1992, the INL operating contractors recovered unused, highly enriched uranium from the spent nuclear fuel via a procedure known as “fuel reprocessing.”

Fuel reprocessing at this facility consisted of dissolving the spent fuel to generate an aqueous solution consisting of the dissolved fuel cladding, unused uranium, and the fission/activation products. The uranium was then separated from the aqueous solution via a solvent extraction technique. After the uranium was separated, the raffinate (waste solution) was temporarily stored in underground tanks; then it was solidified using a high-temperature drying process known as calcination. The calcination process produced a small, granular product (0.3–0.7 millimeters) known as calcine. Calcination of the fuel reprocessing raffinate occurred from 1962 through 2000 and generated 4,400 cubic meters of calcine that are stored in several large storage bins.

The INL calcine contains the bulk of the fission and activation products originally in the spent fuel. As a result, it is highly radioactive and is classified as high-level waste. In addition, the calcine contains some Resource Conservation and Recovery Act (RCRA) metals. The combination of radionuclides and RCRA metals makes calcine a “mixed” waste. Some of the radionuclides and RCRA metals in the calcine are in a leachable form, and therefore this calcine is not in an acceptable state for waste disposal. Prior to

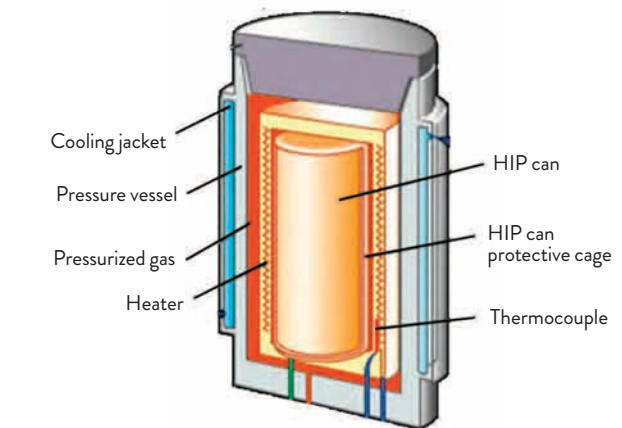

FIGURE 1: Representation of HIP Can filled with Calcine for COMSOL Analysis.

disposal, the calcine must be retrieved from its current storage location and treated so as to immobilize the radionuclides and RCRA constituents.

Currently, DOE has contracted with CH2M-WG Idaho, LLC (commonly known as CWI) to perform conceptual design and test work to support the future construction

and operation of a process to retrieve and treat the INL calcine. The project is known as the Calcine Disposition Project (CDP).

» HOT ISOSTATIC PRESSING

THE CDP PROCESS will remove the calcine from the storage bins, place it in stainless-steel containers, and process it using a

hot isostatic press (HIP). The HIP process creates a glass-ceramic (mineral-like) waste form that is stable, immobilizes the radionuclides and RCRA metals, and can be placed in a disposal repository with minimal risk to the environment. The HIP process is fairly common in manufacturing. It simultaneously applies heat and pressure to powdered materials like metals and ceramics to create various shapes that are difficult or impossible to forge or cast.

The CDP is complicated by significant time and budget constraints. The CDP faces deadlines imposed by a settlement agreement between the state of Idaho and DOE to have the calcine processed and ready to leave the state by 2035.

At this stage of the CDP, a stainless-steel container must be designed that can hold the radioactive calcine and then be subjected to the HIP process. The resulting container is referred to as the “HIP can” among the engineers working on the project.

» TESTING WITH A RADIOACTIVE MATERIAL

IT'S QUITE DIFFICULT to actually work with the radioactive calcine. There are obvious risks and costs involved in handling it, making it very difficult to verify whether the HIP process will be effective by working directly with

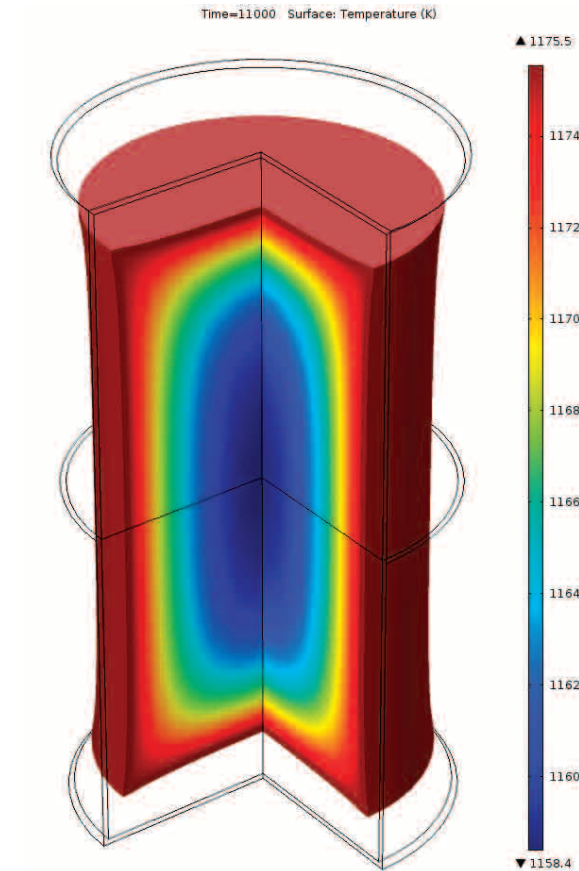

FIGURE 2: Densification and temperature using derived volume change coefficient

the radioactive material.

“This is why CDP has adopted a virtual testing program, validated by physical tests with surrogate calcine, which departs from traditional methods of testing and design,” explains Vondell J. Balls, project engineer with the CDP. “Before the advent of high-performance computers and sophisticated analysis programs, engineers would have an idea and then go to a shop to build it, test it, and break it and then go back into

the design shop and make changes and then go back out again to build and test it until they iterated onto their final design. What we’re doing for the HIP can development and design is to use COMSOL and other analysis software as our virtual test platform. We model, simulate, and test virtually, and then we perform physical tests with surrogate calcine to verify and validate the model.”

Because the radioactive material is so cost-prohibitive to work with, the first full-scale HIP can containing the INL’s radioactive calcine will probably be created when the HIP plant first comes on line 10 to 15 years from now. Currently, the benchmarking that is done involves nonradioactive simulated calcine, which permits accurate predictions about the treatment of radioactive calcine before actual processing begins. Small-scale tests with radioactive calcine will then be performed to confirm the results obtained with the surrogate calcine.

While COMSOL’s modeling and simulation software allows for testing and verification that would be difficult in a real-world environment, it has also demonstrated that the design of the HIP containers can be far simpler than was originally anticipated.

“When we started this project a couple of years ago, experts were telling us

“What we’re doing for the HIP can development and design is to use COMSOL and other analysis software as our virtual test platform.”

—VONDELL J. BALLS,
PROJECT ENGINEER,
CDP ENGINEER

that the can design would be very complicated and that it was very tricky to make these cans and maintain their integrity through the process. As we've gotten into the simulation and testing process, we haven't found that to be the case. We've found the can and welds design can be very simple," says Dr. Delwin C. Mecham, project engineer, treatment technical lead for the CDP.

Simplicity in place of complexity is not the only benefit that has come from the modeling and simulation process. The time and cost of the technology development has been reduced dramatically.

"At this point, we believe that we have already cut out two years and \$1 million from the testing costs," says Mecham. "A year ago, we had planned that we would need to perform three half-scale tests to meet design development goals. Because of the modeling and simulation, we only needed to do one test at half scale

“ We believe that we have already cut out two years and \$1 million from the testing costs.

—DR. DELWIN C. MECHAM, PROJECT ENGINEER, CDP TREATMENT TECHNICAL LEAD

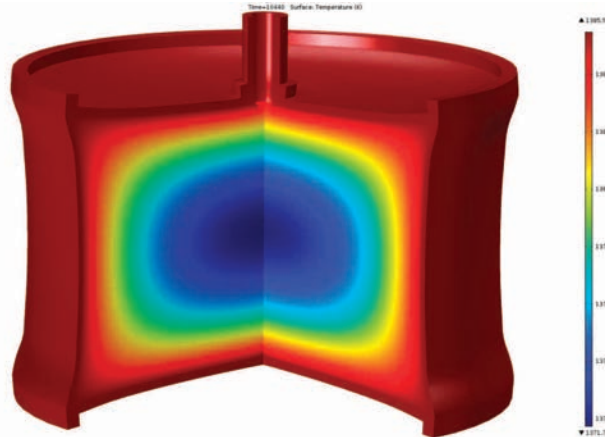

FIGURE 3: Densification and temperature using Ashby's deformation rate equations.

to get the same data."

The accuracy of the models has been a revelation to the engineers. When they performed physical tests with half-scale HIP cans using the surrogate calcine, they detected an anomaly that seemed to indicate that the models were somehow off. On further investigation, they discovered that the problem arose from the physical tests, where there was a void of material in the process used to fill and seal the HIP can. The model was updated to simulate that void, and the associated simulation results then matched the physical test results, further validating the virtual modeling program.

» MODELING AND SIMULATION AS QUALITY CONTROL

SO REALISTIC ARE the models and simulations that in the future operation of

the CDP plant, the models will serve as a simulated real-time monitor of the HIP process.

"As the HIP can inside the HIP machine is going through its programmed time, temperature, and pressure profile, known as the HIP cycle, we will not be able to see it," says Balls. "As part of the plant control system, we're going to use COMSOL Multiphysics simulations as a virtual confirmation of the HIP cycle. In other words, on the operator's screen will be the model of the HIP process using the multiphysics simulations of the structural mechanics of the can, the interior pressure and heat transfer of the argon to the HIP can, and the calcine material phase change from a granular powder to a liquid. On the operator's screen, we'll see this simulation of the HIP can and its contents

as the HIP machine goes through the HIP cycle. So if we have to shut the process down, we will know where we were with that HIP can and the condition of the contents. Linking the physics together using COMSOL will be the key to the accuracy of the simulations needed for this project. During preliminary design, the project will be conducting hundreds of full-scale HIP can tests with surrogate material to develop the validation database required for the waste form permitting and the virtual simulations."

"While this kind of real-time window into the HIP process is a plan for the future use of simulation in the project, COMSOL has already managed to help the CDP attain its technological readiness levels for advancing the project from conceptual design to preliminary design," says Troy P. Burnett, P.E., treatment analysis lead for the CDP. "COMSOL is working directly with us on this problem and has provided excellent support in modeling the physics of large deformations and particle, heat-transfer, and phase changes. This modeling has played a key role in attaining technological readiness levels preparatory for the CDP's Critical Decision 1 stage, which will advance the project from conceptual design to preliminary design." ©

MODELING SCAR EFFECTS IN ELECTRICAL SPINAL CORD STIMULATION

BY EDWARD BROWN

SINCE THE 1960S, spinal cord stimulation (SCS) has been used to alleviate chronic back and leg pain. The process involves surgically implanting a series of electrodes, which are used to apply electrical potentials directly to the spine (see Figure 1). Although approximately 30,000 such procedures are performed each year, there is still not a precise understanding of SCS's mode of action. SCS somehow interferes with the human pain signaling circuitry. In the past 15 years, researchers have begun to develop a more detailed understanding of the effects of this stimulation. What makes the method attractive is that it is known to have beneficial results without many of the side effects of long-term pharmacological treatment.

One of the phenomena associated with this treatment is that it remains effective for many years, although over the course of time the stimulation generally has to be reprogrammed to modify the original parameters. As early as four to six weeks after the electrode is



Discussing the spinal cord stimulation modeling results. From the left Mr. Kris Carlson, Dr. Jeffrey Arle, and Dr. Jay Shils. All with the Neuromodulation Group at Lahey Clinic in Burlington, MA.

implanted, scarring occurs at the interface of the electrode and the surrounding tissue. Paradoxically, while this helps keep the paddle that holds the electrodes securely in place, it alters the electrical characteristics of the system, so that the stimulation has to be reprogrammed. The reprogramming is generally done through trial and error.

Research into this phenomenon was performed by Jeffrey Arle, a neurosurgeon with a degree in computational neuroscience; Jay Shils, who has

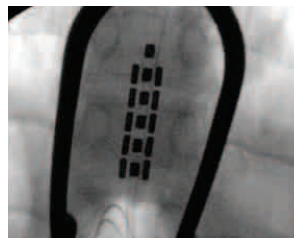

FIGURE 1: X-ray image of a stimulator electrode array on the spinal cord for treatment of chronic back pain.

a background in electrical engineering and computational neurophysiology; and Kris Carlson, who has expertise in programming and along with Shils

has become an expert in the use of COMSOL software. They are all with the Neuromodulation Group at Lahey Clinic in Burlington, Mass., and have concluded a study based on the hypothesis that the formation of relatively higher-resistance scar tissue alters the impedance seen by the implanted electrodes, which in turn alters the pattern of the electric field distribution. It was their thesis that a 3-D mathematical model could be used to accurately predict these changes and define the necessary cor

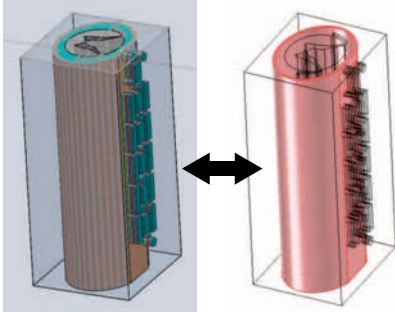

FIGURE 2: The geometry created in SolidWorks (left), imported into COMSOL Multiphysics, yields the most complex model of its kind created to date. Most work by medical device companies is done in 2-D. The 3-D model created by Lahey Clinic has 4³² possible configurations of scar and electrode.

rective modification of the stimulus pattern. Reprogramming the stimulation accordingly could then reverse the deterioration in the performance of the treatment that is often observed.

» MODELING

DRAWING ON EXTENSIVE earlier work done by their group, the three had a great deal of data that included precise measurements of the spinal cord segments and estimations of the numbers of neurons in each and the numbers of each type of neuron. They were also able to draw on detailed published work on the so-called “white matter,” (or axons—the “wiring” that carries signals from neurons in the spine up to the brain). Their plan was to store this data as a digital database so that it could be accessed and manipulated. This database was then used to build a 3-D model of the spinal cord, one that was much more accurate than anything that had been done in the past.

The basic structure of the model was built using the SolidWorks® CAD platform. The SolidWorks model could then be imported into COMSOL Multiphysics so as to solve some of the critical problems encountered with

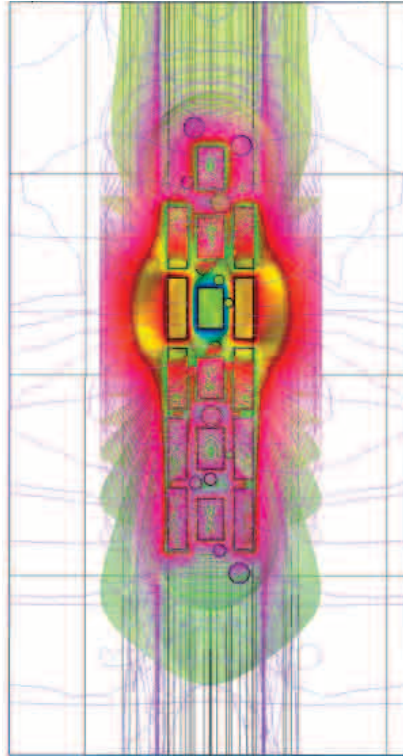

FIGURE 3: View of the stimulator array on the spinal cord, with scars, electric field isopotential, and contour lines. Scar conductivity is initially set to that of tissue, and anodes (red) properly shield cathode (blue) field from unwanted regions and toward center target.

SCS. “The great advantage of COMSOL is that you can not only import CAD from SolidWorks, but you can subsequently make changes in these geometries, press a button, and these changes appear in the COMSOL model without losing any of the settings or material properties,” says Carlson.

» COMPUTING

THE GOAL OF this particular project was to examine to what extent scar formation affects the electrical field distribution between the electrodes and axons. This is important because the axons running through the spinal cord (the white matter)

are either activated or not, based on the strength of electrical stimulation, which is governed by the gradient of the potential field. This is significant because it’s the axons that carry the pain control signals to the brain.

The team wanted to learn just how the implanted electrodes treated the pain. So part of the process was modeling the circuitry in the spinal cord and the effects of the electricity on that circuitry. In order to get to that stage, they had to understand exactly what in the spinal cord actually gets stimulated. That’s where the COMSOL software came in—to “model the electric fields from the electrodes themselves and all of the tissue characteristics they pass through,” says Arle.

The spinal cord is essentially floating in cerebrospinal fluid (CSF), which is in turn surrounded by a tube-like membrane called the dura. The stimulating electrodes sit outside the dura, which is tough and electrically resistive. The different materials have very different conductivities, that of the dura being low and that of the CSF being a couple of orders of magnitude higher.

To study the electrical environment, the team created a finite element model of the gray and white matter in the cord, dura, cerebrospinal fluid, epidural tissue, scar tissue, and stimulator electrodes. The gradients of the system are affected by the relative conductivities of these different materials.

One reason an accurate model is required is that the potential field can vary along the length of the spinal cord. It’s possible that at one point there isn’t a high enough potential gradient to generate an activation potential at the neuron, while 0.5 or 1 millimeter away you may have that critical gradient. These variations can occur for a number of different reasons. The electrode geometry may be different; the material may not be uniform, for instance, the dura itself

might not be uniform across the cord; or there may be material such as scarring that could give one area of the cord a higher resistivity than another. There are also variations of the potential field in the cerebrospinal fluid along different parts of the cord.

“Using SolidWorks and COMSOL together made it very easy to change the geometry with SolidWorks and study the resulting changes in conductivities and permittivities with COMSOL,” says Shils. “This meant that the output of the simulation could be spatially added to a model that we have in-house of a neural network. This gives us a more accurate understanding of where the action potentials are occurring in the spinal cord, and given some of the complexities, it was nice to be able to show that a little change in one place could really shift the energy gradient.”

Carlson explains how the team uses simulation in its work: “We decided to do very sophisticated geometry, much more so than anything that had been done in the past. Not only 3-D as opposed to 2-D, but a much more accurate profile of the spinal cord. In the model, we set all the material parameters. We can play with those—mainly the conductivities, and then the physics—we change the voltages, pulse widths, and frequencies of the various electrodes. So for the scar study that the two doctors designed a year or so ago, we have an incredibly sophisticated geometry. There are 64 different pieces of scar and 64 electrode positions scattered on the surface of the spine, and each of those is very easy to manipulate in the software. Another great feature is that after we run the simulation, we perform a huge amount of post-processing. With the graphic features, we can run all different kinds of filtering criteria and also export the data and perform further post-processing in tools dedi-

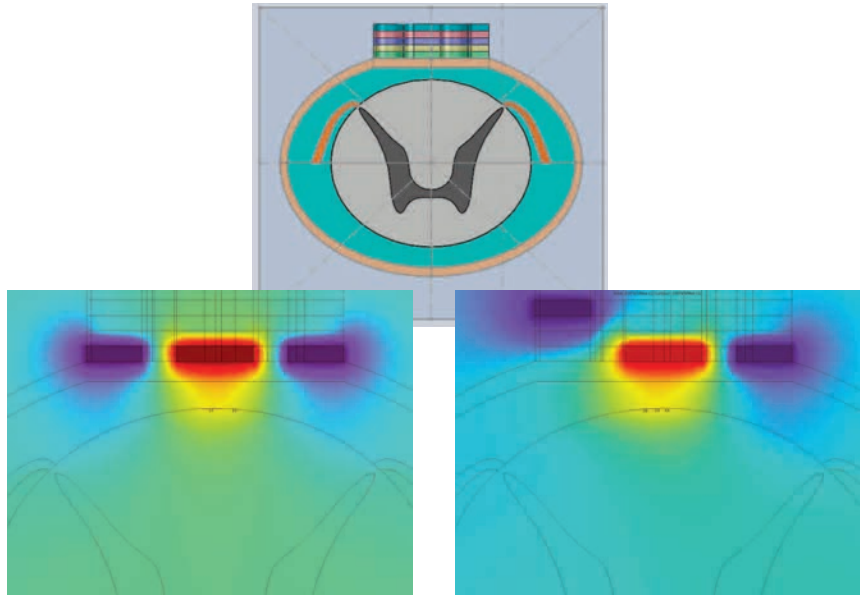

FIGURE 4: Slice plot and contour values of electric field projecting into the spinal cord. **Top:** Cross section of electrode array on the spinal cord. **Left:** Control with no scar. **Right:** Scar under left electrode reduces proper field symmetry. Contrary to expectation, scar tissue can result in higher field values projecting into the spinal cord and too much stimulation.

cated for the purpose” (See Figure 3).

“The formation of scar tissue changes the playing field,” says Arle. “Usually, the programmer is left not knowing what the scar looks like exactly and trying to move the stimulation around to get the best treatment for the patient. Now, by adding only a little bit to the model, we can begin to see the distortion of the electrical fields caused by the scar formation.” The procedure is proving to be extremely effective in immediately relieving pain once the programming is on target (See Figure 4).

“It’s very important that you understand what you’re doing with COMSOL Multiphysics,” says Shils. “You have to understand the physics of what you’re using—why you’re using a certain model as opposed to another. The way you choose the meshing, which COMSOL allows you to do with great flexibility and precision, is a critical part of the analysis. You choose the proper elements and then figure out what the edges are supposed to be. The next step

is to choose the appropriate equations, starting points, and meshing. Mesh quality is of particular importance, especially around the curves of the axons, which is where most of the activation is located. If mesh resolution is inadequate, we could miss the high points of the field and gradients.”

» WHAT’S NEXT?

BY IMPORTING COMSOL data showing which nerve fibers fired into the group’s own neural circuitry simulation software, they intend to unravel how SCS produces relief from pain. Arle sums up his feelings about the project this way: “In biological systems in human anatomy and physiology systems, there’s not a huge amount of work done on this kind of thing, as opposed to more engineering-based projects. You really need to understand the anatomy, the physiology, and the neuroscience, and then ramp this up to understand the mathematics and the physics. People are beginning to realize that you need to take this approach to really understand what we’re doing.” ©

UPGRADING THE NUTS AND BOLTS OF THE ELECTRICAL GRID FOR A NEW GENERATION

From traditional to emerging technologies, the parts that make up the electrical grid are on a continuous path of improvement, supported by simulation and modeling tools

By **DEXTER JOHNSON, PROGRAM DIRECTOR, CIENTIFICA & BLOGGER, IEEE SPECTRUM ONLINE**



THE HUGE ENGINEERING project of migrating the electrical grid to a “smart grid” mostly gets discussed in terms of IT issues or embedded systems, but the forgotten part of the story is updating the “nuts and bolts” of the grid.

The issue of modernizing items like transformers, cable joints, terminations, bushings, and fault current limiters (FCLs) are critical elements in what may turn out to be one of the largest engineering projects of the next decade.

These parts of the grid will ultimately prove just as key to enabling the next-generation “smart grid” as any other aspect of it. And though these parts may seem humble on their own, it in fact requires a lot of engineering to get them right.

Large power transformers, like this from ABB, are an example of the critical equipment needed to distribute electricity in an efficient way. One type of feed bushings can be seen on top of the transformer tank.

IMAGE: COURTESY OF ABB

» HIGH-VOLTAGE CABLE JOINTS, TERMINATIONS, AND BUSHINGS

ITEMS INVOLVED WITH high-voltage cables, such as cable joints, cable terminations, and bushings, are often overlooked.

Cable joints are used to connect two power transmission cables (AC or DC). Cable terminations are used as “end plugs” for a cable that may later be connected to another cable or some added external equipment.

Finally, bushings are devices that let conductors pass through a grounded wall. Bushings prevent flashover or breakdown when a high-voltage conductor is penetrating a metal wall. In other words, each part of the grid is capable of bringing at least part of it down if it’s not properly engineered.

The area of bushings and connectors is a field that Göran Eriksson, a scientist with ABB AB Corporate Research Power Technologies in Sweden, has been addressing in his research.

In particular, Eriksson has been looking at the problem caused by the use of increased voltages in modern transmission systems. The aim of increasing the voltage is to reduce line current and the resulting resistive loss in the cables.

Unfortunately, the straightforward engineering solution of using larger equipment to avoid flashover or dielectric breakdown in insulators brings higher business costs. While there are always increasing demands for higher voltages and power ratings, at the same time there is a strong pressure to reduce the size and cost of equipment.

» ACCOMMODATING BUSINESS AND TECHNOLOGICAL CONSIDERATIONS THROUGH DESIGN

ONE METHOD ENGINEERS have employed for keeping the size of transmission systems to a minimum is the use of so-called field grading materials (FGM), which have an elec-

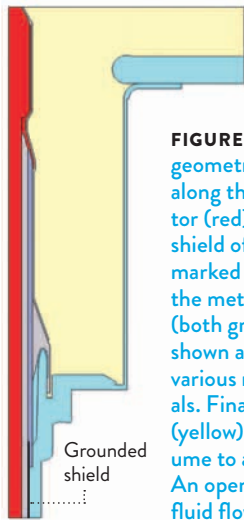

FIGURE 1: Shows the axisymmetric geometry. The main current is flowing along the inner high voltage conductor (red). The interrupted grounded shield of the connected cable is marked with black while blue denotes the metallic oil container and the wall (both grounded). The FGM layer is shown as purple and grey denotes various non-ideal insulating materials. Finally, the upper boundary of the (yellow) oil volume connects this volume to a much larger oil container. An open boundary condition for the fluid flow is therefore applied there.

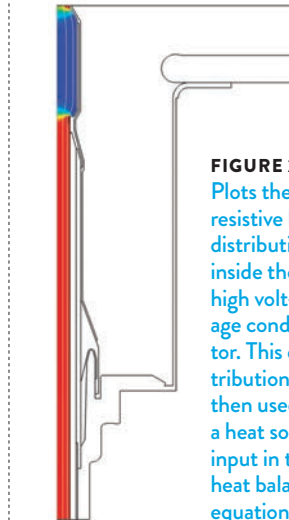

FIGURE 2: Plots the resistive loss distribution inside the high-voltage conductor. This distribution is then used as a heat source input in the heat balance equation.

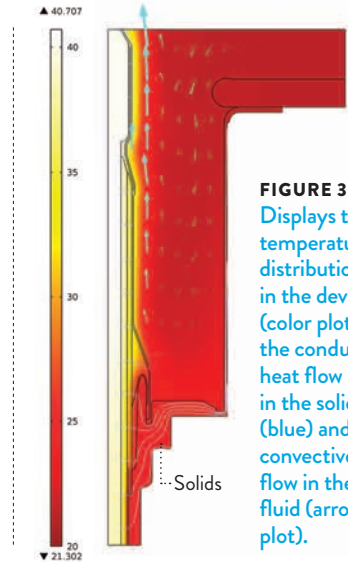

FIGURE 3: Displays the temperature distribution in the device (color plot), the conductive heat flow paths in the solids (blue) and the convective heat flow in the oil fluid (arrow plot).

tric conductivity dependent on the local electric field strength.

While employing FGMs more evenly distributes field than when no FGM is used, it is still necessary to follow a careful and detailed optimization procedure to keep the cost and size of the insulation to a minimum.

When designing joints, terminations, and bushings correctly, problems arise that are both electrical and thermal in nature, according to Eriksson. (Figures 1-5 illustrate the different coupled phenomena involved in the simulation of an oil cooled DC bushing.)

“In all cases, there is a large potential difference between the inner high-voltage conductor and the end of the grounded cable shield or the grounded metal wall,” explains Eriksson. “Very high electric fields are created that could result in a flashover or breakdown if no measures are taken (Figure 5).”

With the high field and current levels, there will also be substantial resistive heating in these devices (Figure 2). In many cases, it is cable joints, terminations, and bushings that are the most stressed components in a transmission system, and their reliability is therefore crucial for overall performance.

The complexity of the problem necessitates the use of simulation and modeling tools, according to Eriksson. There is a strong connection among electromagnetic, thermal, and fluid phenomena in the behavior of these systems, so the physics of the systems become quite involved.

“The physics are very complex and truly multiphysical,” explains Eriksson. “Many of the material parameters are dependent on the local electric field strength and the local temperature.

“The electrical and thermal problems are therefore strongly coupled. In addition, the thermal problem is frequently coupled to the equations describing the flow of a cooling liquid or gas, which transports and removes the heat generated inside the device (Figures 3-4). For very large, high-voltage bushings there may also be mechanical considerations involved.

“With so many material and geometrical parameters involved, finding an optimized solution by experimental prototyping and testing becomes practically impossible, besides becoming far too costly and time-consuming,” says Eriksson. “By employ-

ing simulations instead, it’s possible to make full-parameter optimizations and to evaluate proposed design concepts in a short time.”

The results obtained by using COMSOL’s Multiphysics tool to improve the bushings have been dramatic.

“The component size can be significantly reduced compared to when no—or only simplified—simulations are carried out,” says Eriksson. “Also, the occurrence of any unwanted electrical and thermal hot spots, which tend to reduce reliability, can be better predicted and kept under control.”

In cases, measurement of physical prototypes is not a realistic

“By employing simulations, it’s possible to make full-parameter optimizations and to evaluate proposed design concepts in a short time.”

—GÖRAN ERIKSSON, ABB AB
CORPORATE RESEARCH
POWER TECHNOLOGIES

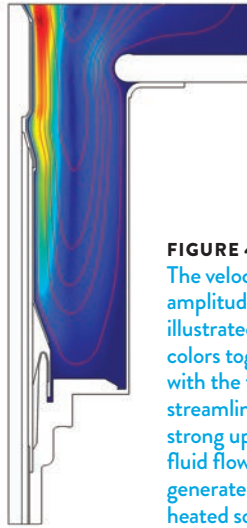

FIGURE 4: The velocity amplitude is illustrated by colors together with the flow streamlines. The strong upward fluid flow is generated by the heated solid parts.

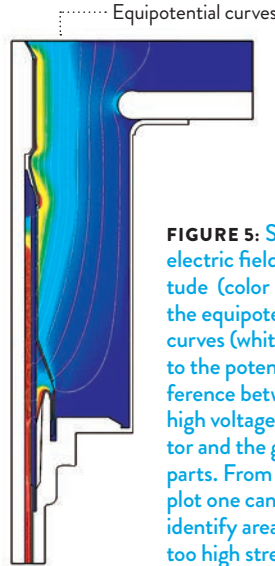

FIGURE 5: Shows the electric field amplitude (color plot) and the equipotential curves (white) due to the potential difference between the high voltage conductor and the grounded parts. From such a plot one can easily identify areas with too high stress levels.

option, according to Eriksson. This is because of the large associated costs in terms of time, money, and lab resources. In fact, some important parameters may not even be accessible using only measurements.

To quantify just how much impact the use of simulations can have on an engineering issue, in a similar case Eriksson encountered it was possible to reduce the size of the feed-through device by almost 30 percent compared with the original design proposal.

» SUPERCONDUCTING FAULT CURRENT LIMITERS

WHILE ENGINEERS ARE improving the traditional parts of the grid, like the joints, terminations, and bushings of electrical cables, work is also progressing on bringing emerging technologies into the grid.

One area where the power utilities would like to find an improved solution is in fault current-limiting (FCL) devices, which respond to the condition of the system and insert increased impedance in the event of a fault.

FCLs protect electrical equipment and the grid infrastructure from fault

currents caused by short circuits, which typically result from lightning strikes.

“The simplest condition-based FCL device is a fuse,” explains Dr. Michael “Mischa” Steurer, a scientist at the Center for Advanced Power Systems at Florida State University (FSU-CAPS). “The major disadvantage of a fuse, of course, is that it has to be replaced when blown in order to restore power flow on the affected circuit.

“The solution of fuses and fuse-based devices also runs into problems because they are not readily available for voltages much above 36 kilovolts. It’s because of this that there is a strong interest by the utility industry in the development of condition-based FCLs, which reset by themselves, preferably under load current flow.”

A possible solution for developing FCL devices has been the application of superconducting materials. According to Steurer, most superconducting fault current limiters (SFCLs) exploit the substantial resistance increase of the superconductor when the transport current, the external magnetic field, and/or the temperature exceed their respective thresholds.

» OBSTACLES TO WIDER ADOPTION OF SFCL TECHNOLOGY

THE DISCOVERY OF high-temperature superconductors (HTSs) ushered in a period of intense excitement and optimism in the development of superconductor-based applications. Nevertheless, even with HTSs the challenge of developing a cost-effective SFCL solution has proved to be daunting, and progress toward commercialized devices has been slow.

One key challenge to SFCL adoption that remains is the associated cost of cooling. Usually, liquid nitrogen (LN₂) acts as a coolant. Heat influx from the ambient and losses in the SFCL (e.g., in copper leads, AC losses in the superconductor or substrate, and core losses if the core is in contact with LN₂ and is penetrated by the magnetic field) cause some LN₂ to boil off. This requires LN₂ refills or reliquefaction.

In order to appreciate the other technological hurdles that SFCLs face, one has to discuss the main SFCL technologies.

SFCLs may be classified into quench and nonquench types, according to Steurer. A quench-type FCL offers effectively zero impedance due to a superconducting state under normal power system conditions. But when there is increased current flow in the power system due to a fault, impedance increases because the superconducting FCL “quenches”—transitions from a superconducting to a resistive state.

Steurer adds that there is a subset of quenching FCLs called resistive FCLs.

These come in various packages in which the superconductor carries the network current, and there must be power leads into and out of the cryogenic tank where the superconductor is housed.

“As one might suspect, it is a challenge to keep heat from conducting into the cold environment,” says

Tim Chiochio, a research assistant at FSU-CAPS. “Another challenge comes from the fact that the resistive SFCL initiates its current limitation through the quenching of its superconductor.”

Another type of SFCL, the saturated iron core SFCL, acts like a variable inductor. The superconductor does not quench but is employed as a DC magnet that saturates the iron core during normal operation. With the iron core in saturation, the inductance is small, but it becomes significantly larger as high fault current drives the core into the linear region of the iron core’s characteristic magnetizing curve.

One issue with this technology is preventing transient currents from being induced in the DC magnet. Another challenge is minimizing the weight and size of the iron core while maintaining the required reactance under system fault conditions.

The shielded iron core SFCL also acts like a variable inductor. During normal operation the superconductor acts as a magnetic shield, preventing the iron core from exposure to the magnetic field of the AC windings connected to the grid. In the event of a fault, the magnetic field exceeds the critical field of the superconductor, and this leads the superconductor to quench. The superconductor then ceases to behave as a shield, and inductance rises sharply as the magnetic field reaches the iron core.

As with the use of higher voltages in transmission systems, the issues are not always technological. They can be business-oriented as well.

“Perhaps the biggest universal challenge is to compete with more traditional approaches such as current-limiting reactors, or CLR’s,” says Chiochio. “It is important to keep costs low and to provide a significant performance advantage with respect to CLR-based solutions.”

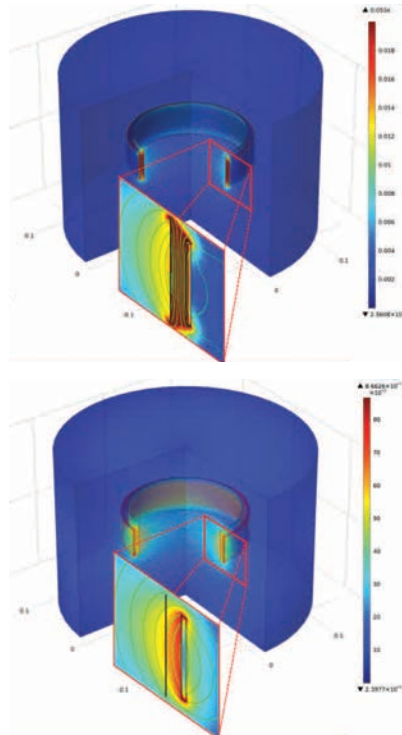

FIGURE 6: (Top) Simulation model showing the magnetic flux density of the bench-top fault current limiter under normal operation. (Bottom) Same but under fault condition.

» MODELING AND SIMULATION IS A CRITICAL TOOL IN SFCL DEVELOPMENT

A TEAM OF researchers at FSU-CAPS funded by Bruker Energy & Supercon Technologies (BEST) is trying to overcome the major design challenges facing SFCLs in order to bring them to the high-voltage grid.

The collaboration agreement between BEST and FSU-CAPS is focused specifically on further developing BEST’s shielded iron core inductive fault current limiter (iSFCL).

Computer modeling and simulation of the device’s behavior have been indispensable tools in this work. The multidisciplinary aspects of the system, including the iSFCL and the electrical grid with all the disparate components that make it up, demand a multiphysics

environment in which to carry out the simulations and modeling.

“Devices such as the iSFCL are embedded in a power system consisting of power lines, transformers, rotating machinery, capacitor banks, circuit breakers, and surge arrestors,” says Dr. Lukas Graber, a postdoctoral research associate at FSU-CAPS. “It is important to model the iSFCL in the appropriate environment, i.e., coupling a model of the power system with the finite element analysis, or FEA, model. COMSOL Multiphysics lets us couple electric circuits—resistors, capacitors, inductors, and sources—with electromagnetic FEA.”

Graber was impressed with how easy it was to couple an electromagnetic FEA with an electric circuit. A tutorial from the COMSOL model library helped him understand and implement this type of coupling.

“Also very impressive was the fact that the simulation model flawlessly converged to a correct solution even though it included a domain with almost zero electrical resistivity— 10^{-15} ohmmeters in the superconductor,” says Graber. “I expected numerical problems with a model that includes such extremely low resistivity.”

The FSU-CAPS team published its model at the COMSOL Conference 2011, which included a model of a benchtop FCL integrated with an equivalent circuit of the driving power electronic inverter and the output transformer.

Graber says the team will use the setup in future tests to do in-the-loop power hardware experiments. The researchers would also like to use modeling to explore more complex configurations of SFCLs and to optimize geometries and dimensions. This will let them simulate the conditions a real SFCL would see in the power system. “Again, COMSOL should allow us to implement an even more complex equivalent circuit,” says Graber. ©

NUMERICAL MODELING OF ELECTROSTATIC PRECIPITATORS

Despite all the press given to alternative sources of power, we still rely heavily on coal for energy production. Alstom designs electrostatic precipitators that are used to clean flue gas, and researchers are using both experiments and simulations to study and optimize these units.

By **ANDREAS BÄCK, ALSTOM POWER SWEDEN AB,**
AND JOEL CRAMSKY, ALVELID ENGINEERING AB



FIGURE 1: A recently commissioned Alstom electrostatic precipitator placed after an 850 MW lignite-fired boiler in Poland.

WITH COAL'S ABUNDANCE and relatively low cost, it has become the primary source of electricity generation around the world. Global coal demand has almost doubled since 1980, driven mainly by increases in Asia, where demand rose by more than 400 percent from 1980 to 2010. In the United States, coal is used to generate about half of the electricity and remains the largest domestically produced source of energy.

A natural result of burning coal is the emission of fly ash, consisting of fine particles derived from mineral matter in the fuel. Increasingly strict emission and environmental standards dictate that virtually all of the dust resulting from coal combustion must be removed. Particle emission limits in the range of 10–30 mg/m³ in the exiting flue gas are common today. Nearly all power plants and many industrial processes employ either electrostatic precipitators (ESPs) or fabric filters to separate these particles from the flue gas. ESPs are popular, due to their low operating and maintenance costs, as well as their robustness towards process variations (see Figure 1). Particle removal efficiencies of 99.9 percent are common, and the world ESP industry has an annual turnover of several billion U.S. dollars.

» THE PRINCIPLES AT WORK

AN ESP USES electrical forces to remove particles from the flue gas. High-voltage discharge electrodes, typically operating at 70–100 kV, produce a corona discharge, which is an ionization of the gas in the vicinity of the discharge electrode. The ions then follow the electric field lines and attach themselves to airborne particles in the flue gas that flows through the ESP, essentially charging them. The charged particles then migrate in the electric field and are collected on grounded metal plates, called collecting electrodes, where they build up to form a dust cake, which is periodically cleaned off. An ESP typically consists of frames with discharge electrodes placed between large metal curtains, acting as collecting electrodes (see Figure 2). The exterior dimensions of an ESP can be as large as 50 by 50 by 25 meters, divided into many independently energized sections.

Increasing the ESP collection efficiency, reducing power consumption, and optimiz-

ing the design from a cost perspective are part of the work at Alstom Power Sweden AB. The Alstom technical center in Växjö serves as the global R&D execution center for the company's studies of environmental control technologies, including particle separation, flue gas desulfurization, catalytic NO_x conversion, and CO₂ abatement. ESP development has traditionally been an experimental and empirical science, although some numerical studies on selected precipitator phenomena have also attracted interest. With COMSOL Multiphysics, it was easy and straightforward to create mathematical models that provided a deeper and more detailed understanding of the behavior occurring inside the ESP.

» **MODELING THE ESP TO ACHIEVE THE** mechanical stability required for a tall collecting plate, it must be profiled or shaped. Because the electric field strength at the plate surface determines when a spark-over (short-circuiting) occurs, it is very important to have smooth curvatures that do not create points of exceptionally high field strength. We studied this using the model in Figure 3, which shows a top view of a symmetry cell of an ESP, with three wires centered between the profiled collecting plates seen in the top and bottom. From

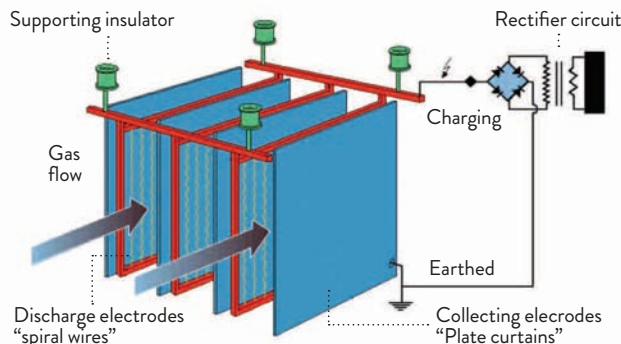

FIGURE 2: Diagram of a duct-type ESP. Note that the use of a negative-polarity corona is shown through the direction of the diodes in the rectifier bridge.

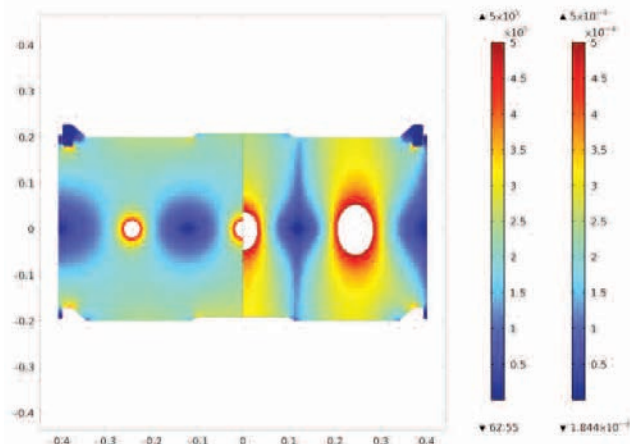

FIGURE 3: Composite color map of electric field intensity (left) and current flux (right) for a 2-D geometry with straight wires and profiled collecting plates. The electric field and current flux intensity is clearly seen to be enhanced at the plate perturbations.

this model, it is seen how the electric field is significantly enhanced by the perturbations on the collecting plates. By comparing experimental observations of spark-over voltages with numerical results for the electric field, we were able to see that sparking occurred at roughly the same electric field at the

collecting plate. This supports the general theory that the maximum local electric field strength at the grounded plates is the critical factor for sparking inside a precipitator.

We developed the first 3D models for studying the spiral discharge electrode, which is often used in Alstom ESPs due to

its even current distribution. Modeling the corona became more elaborate in 3D because the electric field now becomes highly non-uniform on the spiral surface (see Figure 4). The model clearly shows the pronounced nodal pattern of the current distribution on the collecting plates, which is also confirmed by experimental measurements. The current distribution on the plates is an important factor in operating ESPs if the collected dust has a high electrical resistivity, because the combination of a high current and resistivity may cause unwanted ionization inside the dust layer ("back corona").

» COMPARING RESULTS WITH EXPERIMENT

BY COMPARING numerical results with the corresponding data obtained in an experimental high-voltage rig, confidence in the numerical models can be gained. This is exemplified in Figure 5 by the current distribution on the collecting plates. In the high-voltage rig, the current profile on the collecting plates could be measured by gluing a special foil onto the electrode surface. Results from experiments using straight wires and profiled collecting plates were compared with COMSOL results (see Figure 5). These showed excellent agree

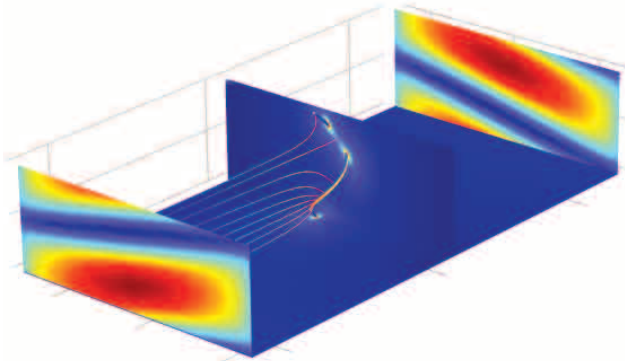

FIGURE 4: A 3D model of a spiral electrode with flat collecting plates. The current density on the collecting plate is shown as the surface plots at the two ends of the model, with a maximum of $200 \mu\text{A}/\text{m}^2$. The other two plots, which are horizontal and vertical slices intersecting with the spiral electrode, show the magnitude of the electric field. This is greatest in the corona region closest to the spiral. Also shown are electric field lines that indicate the direction of the field emanating from the spiral.

ment, and gave confidence in the modeling technique to continue with more advanced simulations.

» FURTHER OBSERVATIONS

CONTRARY TO THE general sizing theory of precipitators based on the so-called Deutsch equation, field experience has shown that the spacing of the collecting plates inside the ESP

may typically be increased without having a negative impact on collection efficiency. To save on material and costs, the standard spacing has therefore increased from 250 mm to 300 mm and then to 400 mm, which can be regarded as the industry standard today. The modeling showed that the migration velocity of a particle traveling towards

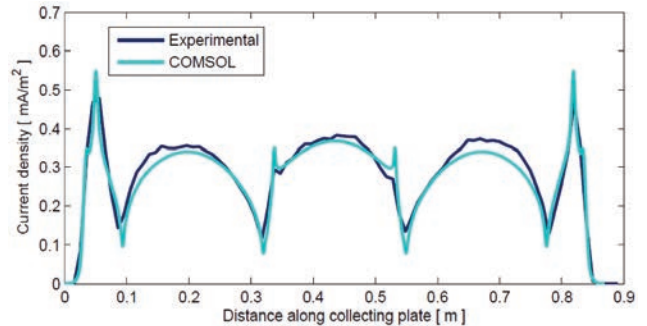

FIGURE 5: Current distribution entering the collecting plates, according to experimental measurement and numerical simulation. The “current spikes” are due to the profiling of the plate. The average current density corresponds to $250 \mu\text{A}/\text{m}^2$.

the plates increases with greater spacing due to a shift of the electric field in the interelectrode region.

A potential problem with ESP operation is what is known as corona quenching or the dust space charge effect. This occurs when the total surface area of the particles entering the ESP is very large, meaning that a large part of the charge in the interelectrode space is carried by slow-moving dust particles rather than ions, reducing the overall current for a given operat-

ing voltage. With a simple COMSOL model, it was easy to estimate the level of corona quenching and relate it to the incoming dust concentration using a semiempirical approach. The fly ash concentration and particle size distribution from a typical coal-fired boiler would completely quench the corona if all particles were fully charged. It is only after a significant fraction of the dust has been precipitated that the remaining suspended particles can reach their saturation charge. ©



ANDREAS BÄCK (left) received his M.Sc. degree in Electrical Engineering from Chalmers University of Technology, in Gothenburg, Sweden, and a Ph.D. in Physical Chemistry from Gothenburg University. Since 2004 he has been working as a research engineer and technology manager at the Alstom technical center for environmental control equipment in Växjö, Sweden. His work has mainly focused on R&D and technical support in the area of electrostatic precipitation, both in the testing facilities in Växjö and at various ESP installations around the world.

JOEL CRAMSKY (right) received an M.Sc. degree in Engineering Physics from Lund University, Sweden, after thesis work on numerical computations for electrostatic precipitators at Alstom Power in Växjö. He is currently working as a structural engineer at Alvelid Engineering in Kalmar, Sweden.

LIGHTNING-PROOF WIND TURBINES

Danish consultancy Global Lightning Protection Services A/S is using electromagnetic simulation to calculate the magnetic fields and current distribution created when lightning strikes a wind turbine in order to optimize protection for internal electronics.



Søren Find Madsen of Global Lightning Protection Services A/S in front of a wind turbine at a test site in northern Spain.

FOR A STRUCTURE standing 150 m high on an elevated site chosen for its exposure to wind, the big concern is not if lightning strikes but when. The number of such direct lightning attachments has risen dramatically in the past decade, along with the increased size of wind turbines and the trend toward placing them in harsh environments, particularly offshore.

Topology and geography dictate the incidence of lightning, creating large regional differences with notable hot spots of activity. Some extreme wind turbine sites experience 10 strikes a day, with lightning typically attaching to one of the blades. In such situations, both the current flowing through the turbine and the magnetic field created by it can interfere with the electronic equipment in the nacelle, the housing that covers the drive components in a wind turbine.

For manufacturers and operators, electromagnetic compatibility is a key consideration, given the potential cost of repair, replacement, and downtime. The big question for engineers is where to best position the panels that shield the control systems and cables connecting the panels so that exposure to the lightning current and the associated magnetic field is minimized. Indeed, lightning protection has become a requirement under the standards set by the International Electrotechnical Commission (IEC 61400-24, as revised in 2010) and Germanischer Lloyd Industrial Services (GL: 2010).

Under these two standards, it is also mandatory to document the effectiveness of the installed lightning protection system. GL: 2010 requires that a lightning protection zone be clearly established; IEC 61400-24 specifies that numerical modeling is an acceptable means of verification.

» EVALUATING FLOW AND VOLTAGE

SØREN FIND MADSEN of Global Lightning Protection Services A/S (previously Highvoltage.dk ApS) explains that in order to verify protection, engineers most frequently draw on results obtained from extensive physical testing of sub-components like blades and external sensors, tests of entire systems like nacelles or control systems, or field experience. None of these approaches can give a completely accurate picture of risks and consequences, and all are expensive and time-consuming. It can, for example cost 400,000–500,000 Euros for a full range of laboratory tests on an entire nacelle. It is more cost effective to model the impact numerically as a first iteration. “Clients seek advice from us at the design stage, when they have to decide on the type and extent of lightning protection,” says Madsen. “That decision is a complex one that needs to take into account numerous variables, such as the type and angle of lightning incidence and the likely route that currents will take.”

It is, for example, possible to use simple linear algebra to resolve the distribution of a DC current injected through a

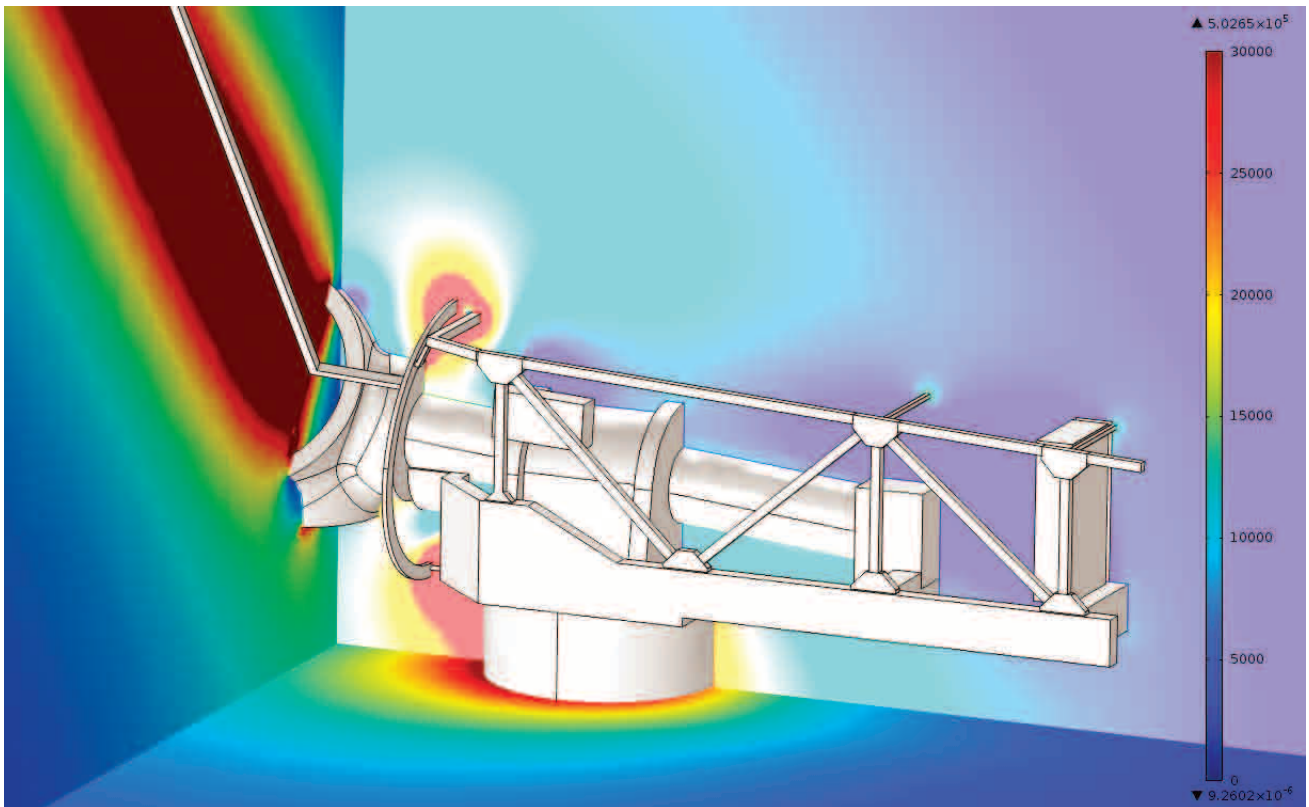

FIGURE 1: Illustration of the magnetic field after a 200 kA @ 25 kHz lightning strike strikes one of the blades.

complex structure because the current will be distributed according to the resistance of each potential route. The current and voltage do not change in time, so there are no mutual couplings in which the current flowing in one conductor induces a voltage on another. On the other hand, AC or transient currents will create mutual couplings, and numerical methods are required to solve the Maxwell equations throughout the structure.

“We find that finite element method (FEM) modeling using COMSOL Multiphysics is enabling us to define couplings and determine the direct and indirect effects (injected and induced current) on shielded cables,” Madsen says “Along with the transfer impedance of the shielded cables, we can evaluate the voltages to be experienced at either end of shielded cables

and select appropriate surge protection or a sufficient level of shielding.”

» PREPARATION OF A CAD MODEL FOR SIMULATION

THE FIRST STEP is to precondition a 3-D CAD model of the wind turbine’s structural components. According to Madsen, “Because 3-D CAD models include such a high level of detail, the FEM modeling environment discretization process would become a bottleneck. In order to model the magnetic field in an entire wind turbine nacelle, we have to simplify the geometry. We are aiming to retain enough detail for a realistic representation yet limit the number of nodes in the computation process so that the numerical solver can actually find a solution.”

The CAD model is therefore imported into SpaceClaim® Engineer

(from SpaceClaim Corp., Concord, Mass.), where it can be easily edited. “We remove small details, such as bolts, nuts and edges; irrelevant material, for example fiberglass and plastic; and unnecessary information, as in manufacturing labels,” says Madsen. “We can keep a higher level of detail around any areas of particular concern, and finally we use COMSOL’s LiveLink™ for SpaceClaim® to transfer the 3-D geometry of the turbine nacelle into COMSOL Multiphysics.” The next step is to create an analysis volume around the turbine as a means of defining where the magnetic field is distributed.

» WAVEFORMS WITHIN A WIDE SPECTRUM

LIGHTNING PROTECTION standards show probability density functions governing the relevant lightning

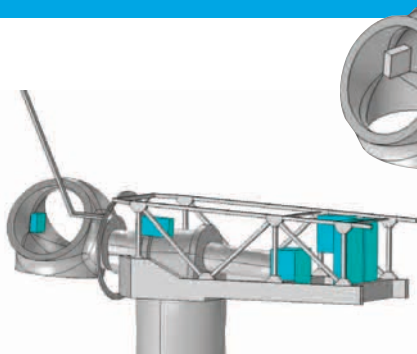

FIGURE 2: Control panels can be added to investigate the magnetic field at specific positions within the nacelle.

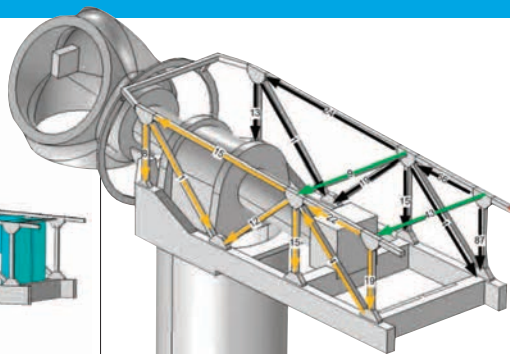

FIGURE 3: Calculated current distribution within the nacelle during a 200-kA lightning strike to the rear right corner of the nacelle. (All numbers refer to kA.)

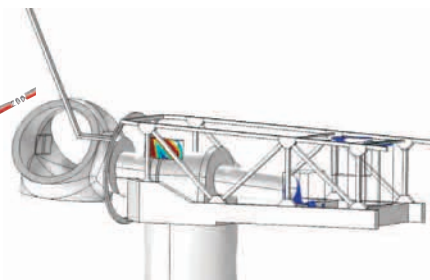

FIGURE 4: Isosurface plot of the magnetic field at the desired positions of the panels. The result is used to determine the shielding requirements for the panels and the installations.

parameters and the frequency characteristic of typical lightning current waveforms. From these curves, three characteristic components of a lightning strike can be derived. They are the first short stroke current, the subsequent short stroke current, and the long stroke current. In natural lightning all possible combinations occur; however, these must be considered individually when modeling voltage drops during the interception of a lightning strike.

Another issue is that the frequency response of a lightning current measurement spans a wide spectrum, from nearly DC to a frequency reaching a few MHz, and these differences must be considered. The skin effect has to be defined, as this will play a major role in current distribution when materials with high permeability and conductivity, such as iron, are considered. For simple calculations of voltage drops along the conductors, it can be assumed that the entire current flows in the cross-sectional area limited by the outer boundary and skin depth. Using the impedance boundary condition within COMSOL Multiphysics, it is possible to treat the solid structure of the nacelle as boundaries, account for the skin effect, and define a 2-D mesh on the geometry surface instead of meshing the whole structure in 3-D. This simplification enables complex geome-

tries to be solved without affecting the results of the numerical simulation.

“In COMSOL we run a series of scenarios where realistic lightning current pulses are injected into the air termination systems,” says Madsen. “We can vary the lightning attachment points and waveforms to calculate current amplitudes, map the magnetic field within and around the nacelle structure (see Figure 1), and highlight the distribution and duration of current in the structural components. We can easily focus on areas of specific interest (see Figure 2) so that designers can evaluate the minimum distance of sensitive equipment from current-carrying structural components. If a panel is to be mounted on one of two iron bars within the nacelle, the iron bar conducting the least amount of current can be selected (see Figure 3).”

» SOLID RESULTS FEED THE DESIGN

GLOBAL LIGHTNING Protection Services A/S is using such results to inform clients about shielding requirements (see Figure 4). With solid data, clients no longer have to rely solely on the somewhat subjective analysis suggested by the IEC standards. In some cases, this leads to a more rigid and stringent design; in others, it allows for more flexibility. In one such example, a design was being

prepared for installation in both high- and low-risk lightning locations.

“One option would have been to make two types of blades, one for each environment,” explains Madsen. “But it is obviously more cost effective to design and manufacture one design. However, there is a tendency to design to the higher-risk location, for safety reasons. We assisted one particular client with the selection of panels required in accordance with the worst-case scenario. We also followed up with physical tests, which confirmed the numerical modeling. Out of an overall development period of several years, it took about three months to produce reliable results indicating that it was safe to reduce the number of shielding panels on the turbine. This created massive savings, as thousands of units were to be manufactured.”

Madsen concludes by commenting on the positive feedback Global Lightning Protection Services A/S has received from customers, which include industry leaders in China, Denmark, and Japan. “They are very impressed with the results we are producing and can see the value of verifying proposed lightning protection at the design stage, when it is still relatively easy and cost effective to make amendments. We certainly expect numerical modeling to play an increasing role in lightning protection.” ©

MATHEMATICAL MODELING: AN INDUSTRIAL PERSPECTIVE

By **RICK NOPPER, DUPONT, WILMINGTON, DE**

AT DUPONT, MODELING is viewed as an enabling technology that supports our wide diversity of science and technology areas. Since the advent of supercomputers, computational scientists have applied their craft as a “third branch of science,” complementing experiment and traditional theory.

It is convenient to divide modeling into two classes, empirical and fundamental. Empirical modeling is data-driven, dominated by data analysis and statistics. On the other hand, fundamental modeling is driven by a set of governing equations, the “theory.” Although theory is guided by empirical evidence, other considerations enter too, such as conservation laws, symmetries, gauge invariance, etc.

The dual nature of modeling suits its progression of application. Initially, empirical models help organize and interpret data, providing useful quantitative relationships. Fundamental models then bring in the applicable theory and codify understanding, both qualitatively and quantitatively, facilitating further development and efficient management of knowledge. Finally, validated fundamental models enable design, optimization, and control of product and/or process. Design and optimization tend to be the main uses to which we put finite-element models.

To accomplish all this, a hardware infrastructure is required. At DuPont, this infrastructure supports platforms from laptop machines to high-performance compute clusters and clouds, in addition to providing administrative computing services to users networked around the globe.

The DuPont technical computing organization provides a hierarchy of software tools. This begins with utilities and “low-level” programming languages. Next are numerical libraries and tools for general mathematical analysis (MATLAB®, etc.). Heavily used are the engineering analysis packages (finite-element such as COMSOL Multiphysics® and process flow-sheet models) and visualization tools. A good collection of statistical applications supports empirical

modeling. Tools for managing databases and large datasets are also important. Finally, we license or have developed special-purpose codes for quantum chemistry, molecular dynamics, particle processes, bioinformatics, etc.

Even with all this firepower, modeling still faces formidable technical challenges. Most problems are ill defined at the outset—modeling can help here. Many problems are inherently multiphysics; fortunately we now have tools which couple diverse and complex phenomena without requiring a major development effort. A number of problems are disordered in some sense (usually in geometry) and span multiple scale sizes. There is no general method for dealing with these, so the approach must be customized.

In an industrial setting, modelers often appear in a consulting role with scientists and engineers on a project. It is important to apply modeling in a way that maximizes its impact—otherwise someone will say it is too expensive. Introduce modeling early on—when it can really make a difference. Understand what you are modeling—and why. Do not oversell the capabilities of models to your colleagues. Understand their experimental methods and data. While getting good input data can be a difficult task, models can suggest what is needed. Perform a scale analysis of the problem to identify what is important and what is not. Draw things to proper (relative) scale. Do hand calculations of simplified cases; these provide insight and good test cases for numerical models.

Probe the sensitivities of model results to variations in parameters. Trends in the model results are often useful even if absolute numbers are unattainable or if adjustable parameters are required in the model. Some models incorporate parameter optimization tools for this purpose. Tie your model results to experiments. Finally, don't just throw your model results over the wall. Insist on interpreting them in concert with your colleagues, thus building technical expertise in your organization. ☺



RICK NOPPER works in the DuPont Engineering Department in Wilmington, Delaware. His modeling activities go back to his PhD project (Boston College, 1978), a numerical model of the global ionospheric electric field. At Conoco Petroleum Exploration Research he modeled geologic deformation and heat flow. In 1989, he came to DuPont as in-house consultant and has developed models in many areas: micro-electronic devices, superconducting magnets, filter/barrier materials, reinforced composites, groundwater treatment, atmospheric chemistry and transport, and particle aggregation. In his spare time, he likes to play the jazz keyboard.