

# COMSOL NEWS

A TECHNICAL COMPUTING MAGAZINE



INDUSTRIAL EQUIPMENT:  
STEEL CASTING

11

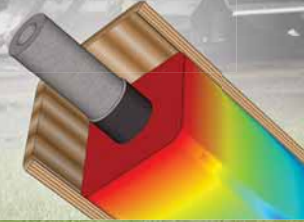

BIO-MEDICAL:  
HI-FI HEARING AID

18



Modeling helps batteries  
jump on the train of  
environmental progress

 COMSOL



Intro

Cov

ToC



## Complimentary Multiphysics Workshops Are Coming to You

**M**ore than 10,000 engineers, researchers, and scientists worldwide wanting to learn more about multiphysics simulation are expected to attend a COMSOL® workshop this year. These half-day events feature a quick demo of COMSOL Multiphysics® followed by a hands-on minicourse where you set up and simulate your first coupled physics model. Previous attendees say that they are amazed at how easy multiphysics modeling can be.

The workshops are free of charge and conveniently located in major metropolitan areas. Make sure to bring your own laptop for an installation of COMSOL Multiphysics that you can continue using after the workshop.

Or follow the lead of your colleagues at STMicroelectronics and arrange for an on-site workshop to jump start your multiphysics modelers. In this issue, STMicroelectronics reports on their successful semiconductor simulation and how their user group initiative helps spread knowledge about COMSOL throughout their organization.

Starting with the Spring '09 series of workshops we have a special treat for you: A sneak preview of COMSOL Multiphysics version 4. Everyone is welcome to join us at a COMSOL Workshop 2009! For an up-to-date listing of workshop dates and locations, visit [www.comsol.com/events/](http://www.comsol.com/events/).

Bernt Nilsson  
Sr. VP of Marketing  
COMSOL, Inc.



## FEATURES

### MANUFACTURING

- 4 Simulation of Manufacturing Process of Ceramic Matrix Composites

### CIVIL ENGINEERING

- 5 Geophysical Wave Propagation

### ENVIRONMENTAL

- 6 Modeling Helps Batteries Jump on the Train of Environmental Progress
- 9 Multiphysics Modeling Studies New Materials that Could Revolutionize Solar Energy

### INDUSTRIAL EQUIPMENT

- 11 Ugitech Optimizes Steel Casting Process Using COMSOL Multiphysics
- 14 Qualifying COMSOL for Nuclear-Safety-Related Procedures

### CONSUMER PRODUCTS

- 16 Analysis of Unique Loudspeaker Driver Possible Only with Multiphysics Modeling

### BIO-MEDICAL

- 18 Hi-Fi Hearing Aids with Multiphysics Modeling

### COMSOL MULTIPHYSICS 4

- 20 New Products Preview

### MATERIALS

- 22 ArcelorMittal Breaks Down the Physics of Corrosion

### CHEMICAL

- 25 Simulation Addresses Band-Broadening in HPLC Systems
- 28 COMSOL Reveals How to Avoid Very Expensive Modifications to Wastewater Clarifier

### SEMICONDUCTORS

- 30 Reduced Stresses Inside Semiconductor Chips Lead to Higher Reliability

### AEROSPACE

- 32 Sun-Powered Flight

## DEPARTMENTS

- 34 Multiphase Flow

- 36 support@comsol.com

- 37 COMSOL Conference 2009

### COLLABORATION

- 38 Leveraging 3D Direct Modeling Tools for CAE and Model Preparation

- 39 SpaceClaim Engineer

### GUEST EDITORIAL

- 40 Dr. Amy Duwel — Physics Modeling in Generation X and Beyond



Photo courtesy of GE Transportation.

### On the Cover

General Electric's Eco-magination<sup>SM</sup> technology is exemplified by the Evolution<sup>®</sup> Hybrid Locomotive. GE will utilize batteries to help power these locomotives.

## COMSOL NEWS

We welcome your comments on COMSOL NEWS; contact us at [news@comsol.com](mailto:news@comsol.com).

© 2009, all rights reserved. COMSOL News is published by COMSOL, Inc. and its associated companies.

COMSOL, COMSOL Multiphysics, COMSOL Reaction Engineering Lab, and FEMLAB are registered trademarks of COMSOL AB. Other products or brand names are trademarks or registered trademarks of their respective holders.







It's too expensive to develop new technologies in the real world.

Develop them in ours.



At AltaSim Technologies, we are a team of engineers experienced in simulating real world events in a virtual environment. With our capability in multiphysics analysis, we can identify the interdependent effects of multiple, simultaneous physical phenomena, whether they be structural, fluid, acoustic, chemical, electromagnetic or thermal in nature. This allows you to rapidly screen concepts to increase the rate – and success – of new product development. It improves manufacturing processes as well.

Make your technologies a quicker and more profitable reality through our expertise in multiphysics engineering.



Contact us today:

(614) 861-7015

[www.AltaSimTechnologies.com](http://www.AltaSimTechnologies.com)



Intro

Cov

ToC



# Simulation of Manufacturing Process of Ceramic Matrix Composites

ALTASIM TECHNOLOGIES, COLUMBUS, OHIO

Increasing the temperature at which jet aircraft engines operate would significantly improve thrust and fuel efficiency with reduced emissions. However, current engines operate within 50 degrees of the inherent melting point of the conventional materials used in engine construction, thus new materials capable of operating at higher temperatures for prolonged times must be developed and manufactured. Ceramics and ceramic matrix composites (CMCs) can operate at temperatures in excess of 2000°F but are difficult to fabricate into the complex shapes required for jet engine use and consequently novel manufacturing processes must be developed and processing conditions optimized for routine production of complex components.

To support the development of these innovative manufacturing processes

AltaSim Technologies has applied COMSOL Multiphysics® to simulate the manufacturing process of CMCs. Specialized multiphysics simulation tools have been developed to simulate the infiltration of molten material into a ceramic perform. In addition to fluid flow the following physical phenomena must be included to provide a realistic simulation of the CMC production process:

- Unsaturated flow of fluid into a ceramic matrix
- Capillary fluid flow
- Chemical reaction between the fluid and the ceramic matrix
- Volumetric changes associated with the fluid-solid reaction
- Temperature changes associated with the fluid-solid reaction
- Residual stress development and its effect on component shape

Fluid flow described using Richard's

and Darcy's equations have been coupled with partial differential equations describing the chemical reaction between the fluid and the ceramic matrix. Simultaneously, heat transfer in a porous medium associated with both the liquid and solid phase, and thermal and dilatational strains associated with the anisotropy of the mechanical properties of the composite material are solved. The resulting simulation is a simultaneous solution that incorporates the relevant, multiple physical phenomena that describe the manufacturing of CMCs. The analysis tool provides a more accurate analysis of the process and has allowed a more rigorous simulation of the interdependent physical phenomena encountered in the manufacturing process. An example of the velocity distributions from a simulation is shown in Figure 1.

The use of these simulation tools to the analysis of CMC manufacture has allowed designers to analyze the CMC production process and identify the relative significance of the multiple interdependent parameters associated with CMC manufacture. As a result, optimization of critical components of the CMC manufacturing process has been possible thus allowing engineers to reduce cycle time, increase part yield, and optimize the process window for CMC manufacture. The results of analyses using COMSOL Multiphysics have allowed AltaSim Technologies to resolve production issues with new designs prior to mass production and significantly reduce the time and cost of new product development and manufacture.

*This work was performed by Dr. S.P. Yushanov, Dr. J.S. Crompton and Dr. K.C. Koppenhoefer using COMSOL Multiphysics. For more information please contact: K. Koppenhoefer, AltaSim Technologies (www.altasimtechnologies.com), 130 East Wilson Bridge Rd, Suite 140, Columbus, OH 43085. ■*

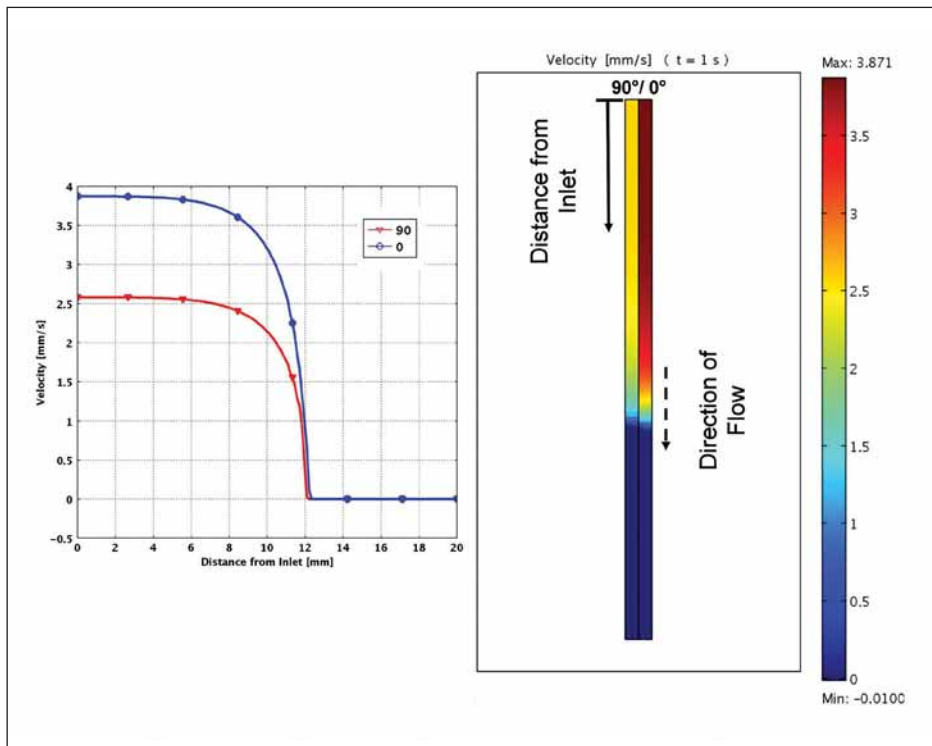

Distribution of the velocity in the fill direction 1s after start of infiltration for a 2 layered CMC, simulation performed by AltaSim Technologies using COMSOL Multiphysics.

# Geophysical Wave Propagation

ALTASIM TECHNOLOGIES, COLUMBUS, OHIO

The propagation of shear (S) and compression (P) waves within the earth allows geologists to track seismic events and to identify subterranean structure. For many years, geologists have developed specialized computational programs to calculate wave propagation within complex geophysical regions. These programs have been instrumental in determining the location and characteristics of natural phenomena (e.g., earthquakes) and man-made activity (e.g., nuclear-blast tests). Since these waves typically travel long distances prior to detection, analyses often require large computational models and significant computational resources. Newer applications for this technology include border security and exploration for natural resources where the length scales are significantly smaller. Thus the P and S waves decay less than the traditional applications with longer length scales and their effects cannot be ignored. As these industries seek to apply existing technology to meet today's challenges, they have discovered significant advantages over the traditional methods. For example,

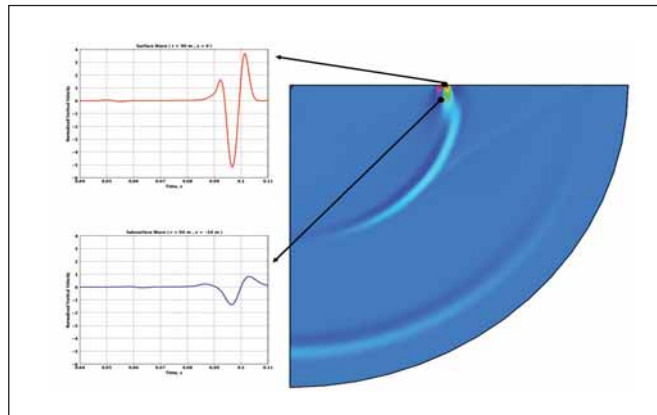

Simulation results for a seismic wave propagating through a geological domain performed by AltaSim Technologies using COMSOL Multiphysics.

ment of Defense, and the energy industry. These industries, as well as many others, are being served by the application of the computational methods in COMSOL Multiphysics. By using new commercially available numerical software, geologists have reduced the need for large computational resources to solve their problems and can now conduct in-field calculations to improve signal processes. These improvements increase the sensitivity for detecting underground activities on our borders and in hostile foreign countries. In the energy industry, operators can use this technology to better understand how existing wells are functioning.

## “New methods of analyzing geophysical wave propagation problems are being developed by AltaSim Technologies.”

COMSOL Multiphysics requires significantly less computational resources than traditional codes thus enabling analysis in the field and future developments in COMSOL Multiphysics will automatically be integrated into any operation.

New methods of analyzing geophysical wave propagation problems are being developed by AltaSim Technologies to provide practical solutions to the Department of Homeland Security, the Depart-

To implement this technology, AltaSim Technologies solved the equilibrium equations for a time-varying system using the finite element method; traditional approaches have focused on the use of finite-difference based algorithms. Use of the finite element method provides greater flexibility by eliminating the need for regular computational grids inherent in the finite difference method, and the finite element mesh more easily represents a

typical geological domain that includes local inhomogeneities.

The example in the figure shows the velocity distribution in a half-space subjected to a dynamic excitation near the Earth's surface. The Cartesian plots show the surface and subsurface response. For the simplified case of a homogeneous half-space, the engineers at AltaSim Technologies implemented closed-form solutions for a wide range of loadings against which to compare the computational results.

The solution for a sinusoidal forcing function was implemented directly into the analysis software to facilitate rapid comparison of computational results with the analytical solutions. The sinusoidal forcing function analyzed in this work represents an impact loading with a total duration of 10 ms. These results show the magnitude of the subsurface wave at 50 meters from the source still have a significant magnitude relative to the surface waves. Thus, the ability to resolve both wave types improves understanding for signals measured from near-surface sensors.

As part of this work, AltaSim Technologies considered the effects of mesh and time step size to develop models that provide accurate solutions while minimizing computational resources. The mesh necessary to solve this problem included 11,000 elements and 90,000 degrees-of-freedom. To limit memory requirements for meshes of this size to be solved on in-field computational resources, the analyses used a PARDISO sparse solver.

*This work was performed by Dr. S.P. Yushanov, Dr. J.S. Crompton and Dr. K.C. Koppenhoefer using COMSOL Multiphysics. For more information please contact: K Koppenhoefer, AltaSim Technologies (www.altasimtechnologies.com), 130 East Wilson Bridge Rd, Suite 140, Columbus, OH 43085. ■*







General Electric's Ecomagination<sup>SM</sup> technology is exemplified by the Evolution<sup>®</sup> Hybrid Locomotive. GE will utilize batteries to help power these locomotives. Photo courtesy of GE Transportation.

## Modeling Helps Batteries Jump on the Train of Environmental Progress

If all diesel electric locomotives were converted to utilize hybrid technology, a potential projected savings of more than \$425 million per year could be realized — using batteries to run freight locomotives makes economic sense. Add this to significant cuts in greenhouse gas emissions and the environmental savings of General Electric's Hybrid Locomotive help move us toward a greener tomorrow. Michael Vallance of GE Global Research is simulating the sodium metal-chloride batteries that will drive GE's hybrid locomotives to enable and even increase these savings.

BY PHIL BYRNE, COMSOL AB

For years, fuel cells had been pushed as the answer for “green” transport even though a commercially viable vehicle was never fully realized. Rather than waiting for a hydrogen economy to be established, hybrid cars such as the Toyota Prius, Ford Escape, Chevrolet Malibu and others have shown that a simpler and better utilization of existing technologies can also lead to substantial improvements in the environmental credentials of a vehicle. Best of all, they're available now.

People have come to learn that such cars, with their repetitive start-stop operation, are an application where hybridized internal combustion/electric drives are more efficient than internal combustion engines

alone. But they may not have suspected that a battery-driven electric locomotive would be practical because a train moves heavy loads at fast speeds for long periods and over long distances. Surprisingly, though, batteries can make a substantial contribution, given that they can provide up to 2,000 horsepower to a locomotive.

### Recovered Energy Cuts Emissions

“One large difference compared to an automobile is that locomotives spend many minutes while dynamic braking, rather than just seconds. This generates considerable energy that's normally lost,” says Michael Vallance. They plan to make use of this energy in their hybrid locomo-

tives to achieve fuel savings of up to 15%, which is equivalent to 25,000 – 30,000 gallons of diesel per vehicle per year, and for eliminating over 300,000 kg of CO<sub>2</sub> emissions – equivalent to that from 2,600 cars. Moreover, the reduction in NO<sub>x</sub> emissions is even more significant.

However, GE had to develop an alternate to the lithium and metal-hydride batteries used in passenger vehicles. They needed versions with higher energy densities that can withstand the environment of a long-haul locomotive. Furthermore, these new batteries must be tolerant of cell failures in high-voltage strings, where batteries with failed cells continue to operate safely and effectively.





Figure 1: A locomotive expends considerable energy when braking. In hybrid locomotives, this energy is harnessed and stored by batteries and can be used to supplement energy from the engine. Diagram courtesy of GE Transportation.



## GE's Evolution<sup>®</sup> Hybrid Locomotive



### How it works

In a conventional locomotive, energy generated by the traction motors **A** during braking is dissipated entirely as heat through resistor grids **B**.

In contrast, in a hybrid locomotive, some of that energy is captured in a series of lead-free, rechargeable batteries **C**.

The captured energy can then be used to provide power in one of three ways:

- In combination with diesel-electric power (provided by the engine **D** and the electrical system **E**) to consistently deliver the required horsepower.
- As an addition to full diesel-electric power for quick acceleration from a full stop.
- As the primary power source (full battery power).

To develop its own high-temperature sodium metal-chloride battery, GE formed a team spanning its Global R&D laboratories, with members in Niskayuna, NY, USA, Shanghai, PRC and Bangalore, India. This team began a close collaboration with the engineers of GE Transportation in Erie, PA, USA. GE's battery technology has now reached the stage where a full-scale prototype operational locomotive is being shown to potential customers. In fact, back in 2007, GE demonstrated its first hybrid freight locomotive, arriving at Los Angeles' Union Station with CEO Jeff Immelt present.

### A Valuable Tip

Michael and his colleagues have since been working with this battery and wanted to better understand the mechanisms that make it function.

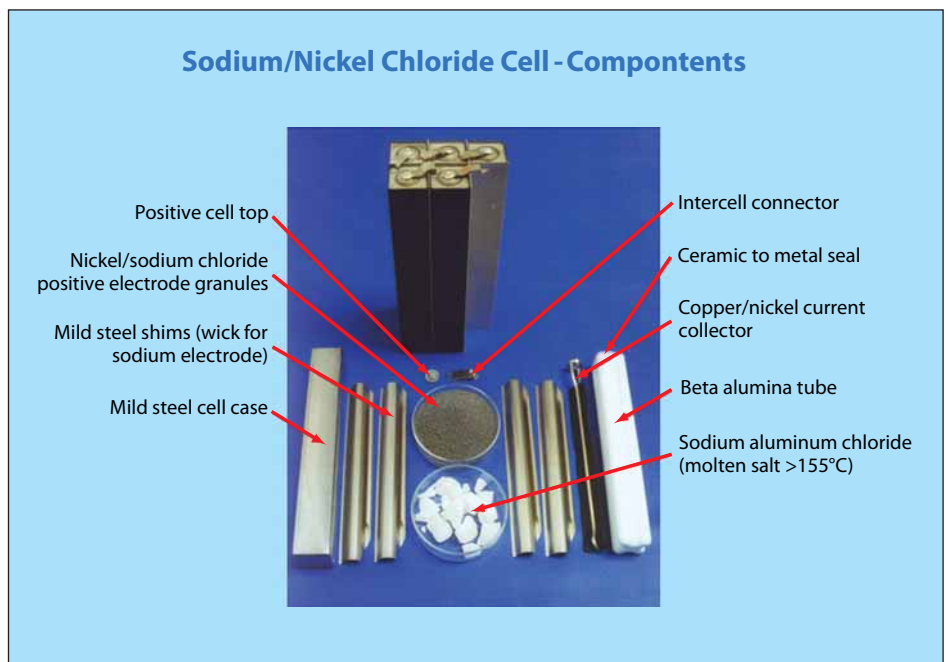

Figure 2: The sodium metal-chloride battery and its components. Photograph courtesy of GE Transportation.

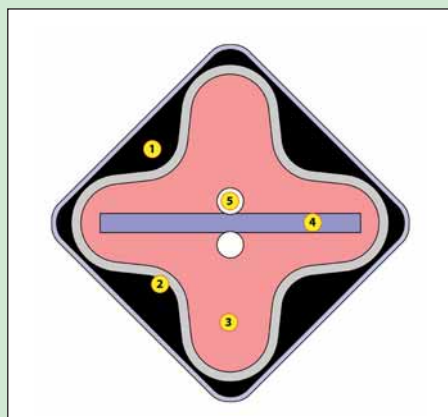

Figure 3. A cross-section of the battery geometry and the various modeling domains:

1. Anode: Molten sodium
2. BASE: Sodium conducting solid electrolyte ( $\beta''$  alumina)
3. Cathode: Iron and molten-salt electrolyte (NaCl-saturated sodium tetrachloroaluminate (STCA))
4. STCA Reservoir
5. Cathode current collector

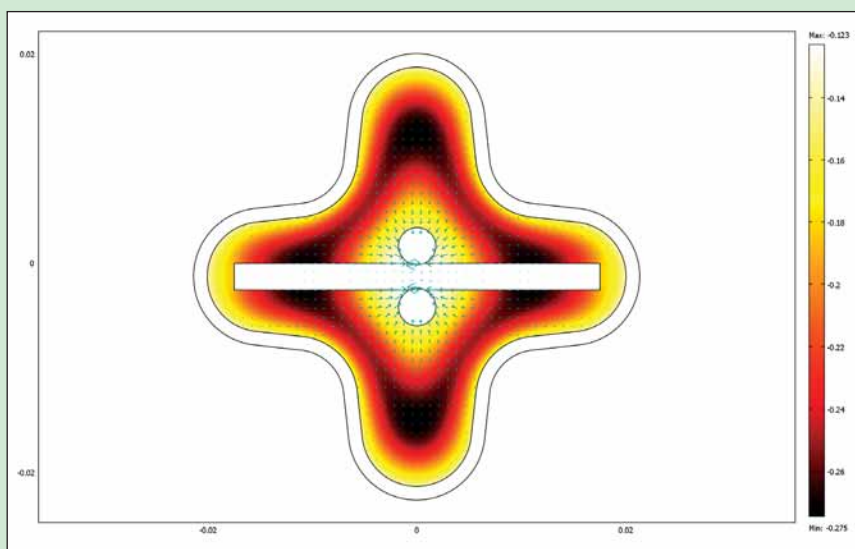

Figure 4: Current density vector and distribution at 58.9% depth of discharge (DoD) in the battery. The arrow plot indicates localized regions of high current density that occur in the area of the connection between the cathode current collector and the STCA reservoir. The color plot indicates the wave front characteristic that the electrochemical reactions undergo within the battery.

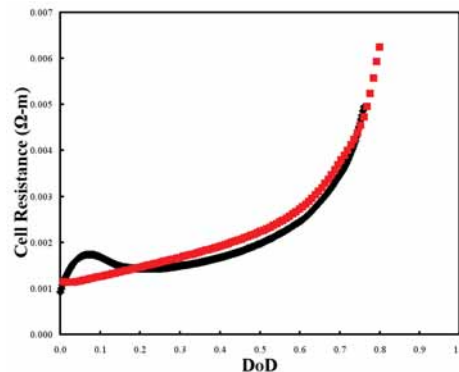

Figure 5: Comparison of experimental results (red points) and the model's prediction (black points) of depth of discharge (DoD) vs cell resistance, which rises significantly after about 60% DoD due to species depletion and transport resistance.

and the species' phases, so operational temperatures must be held within a narrow range.

Considering all of these factors, COMSOL Multiphysics' ability to couple them and solve them simultaneously is a key feature. The software was used to develop an accurate, realistic battery model.

### Understanding Leads to Design Changes

The models he has created have uncovered results that led to a heightened understanding of the battery. In the present version of the battery, the modelers have been able to identify areas of high current density, and this information was used to adjust manufacturing tolerances at critical regions. The model provided additional insights concerning convective flows in the cathode, which lead to an experimental investigation of modified geometries.

The value of modeling even extends into operating issues. Plotting cell resistance versus depth of discharge (DoD – the extent to which the reacting materials in the battery are consumed) indicates when operators should start a recharging cycle. Because cell resistance starts to rise exponentially after about 60% DoD, a battery should not be discharged long beyond this point.

COMSOL Multiphysics will further be useful for investigating other properties such as the battery's structural integrity due to vibrations and other duress it experiences in the locomotive. ■

Michael began to look for a modeling software package that was well suited to simulating the electrochemical reactions and material and energy transport that make up the sodium metal-chloride battery. One option raised was the COMSOL Multiphysics software platform. Michael attended a COMSOL Conference in 2007 to learn more about the software. At the conference he also met one of the leading experts in electrochemical simulations, Dr. Ralph E White from the Dept. of Chemical Engineering at the Univ. of South Carolina, who was able to advise him on how to include advanced electrochemical phenomena in his models.

To fully simulate the operational behavior of a sodium metal-chloride battery, you must involve multiple mechanisms. Electrochemical reaction kinetics as described by the Butler-Volmer equations need to be solved at the electrodes, while the model must also consider the transport of ions to these electrodes through migration, diffusion and convection. A number of participating materials change phase as a part of the battery's charging or discharging operations, and the corresponding kinetics must also be factored in. Furthermore, temperature plays an important role in many of the battery's physical characteristics including ionic mobility



# Multiphysics Modeling Studies New Materials that Could Revolutionize Solar Energy

Fundamentally new solar thermal collector designs based on polymeric materials are interesting because they replace metal with plastics and thus offer the potential of far lower costs. In studying these completely new designs, researchers at the Fraunhofer Institute for Solar Energy Systems ISE must consider a variety of interrelated factors including heat transfer due to fluid flow, heat-induced structural deformation and stress plus the mass transport of water through barriers. COMSOL® is a software package which is flexible and comprehensive enough to handle the different physical tasks simultaneously.

BY KARL-ANDERS WEISS, FRAUNHOFER INSTITUTE FOR SOLAR ENERGY SYSTEMS , FREIBURG, GERMANY

An estimated 50% of fossil fuels are used for heating purposes, so there is a huge potential in replacing them with renewable energy sources such as solar collectors. Today's standard collectors use copper or aluminum as the energy-absorbing material, but consider that if we were to meet just 1% of the world's heating energy with conventional solar collectors would require 22 million tons of copper – and that the worldwide output in 2006 was 17.6 million tons. Add to that recent price increases in metals and there's a clear impetus to examine polymers as an alternative.

However, polymers don't have the same ability to withstand high temperatures as metals do, so we need completely new designs for solar collectors using them. Our working group of roughly 30 people focuses on the durability of future solar energy systems, and modeling is a big part of our work with roughly four people using COMSOL on a regular basis.

In studying new concepts we are starting from scratch and use modeling to understand virtually every aspect of an energy system's operation including heat-transfer due to fluid flow, heat-induced structural deformation and stress plus the mass transport of water through barriers. COMSOL Multiphysics provides an excellent platform that allows us to examine all of these within one easy-to-use environment and optimize system operation before we start building prototypes.

## Design Optimization for Solar Thermal Collectors

The use of polymeric materials in solar-energy applications has many advantages.

First, of course, is its price compared to today's collector materials. Next, polymers offer great freedom in terms of design – we can develop new collector layouts that would be impossible with conventional materials. For instance, with an extrusion process it might be possible to mass-produce complex geometries in lengths of kilometers and bring the economies of scale. Further, polymers allow the manufacture of collectors that are lighter in weight.

Polymeric materials have a low intrinsic thermal conductivity. This, however, can be compensated by optimized collector geometries with the goal being a layout that assures homogenous flow and maximized

“COMSOL Multiphysics provides an excellent platform that allows us to examine all physics within one easy-to-use environment and optimize system operation before we start building prototypes.”

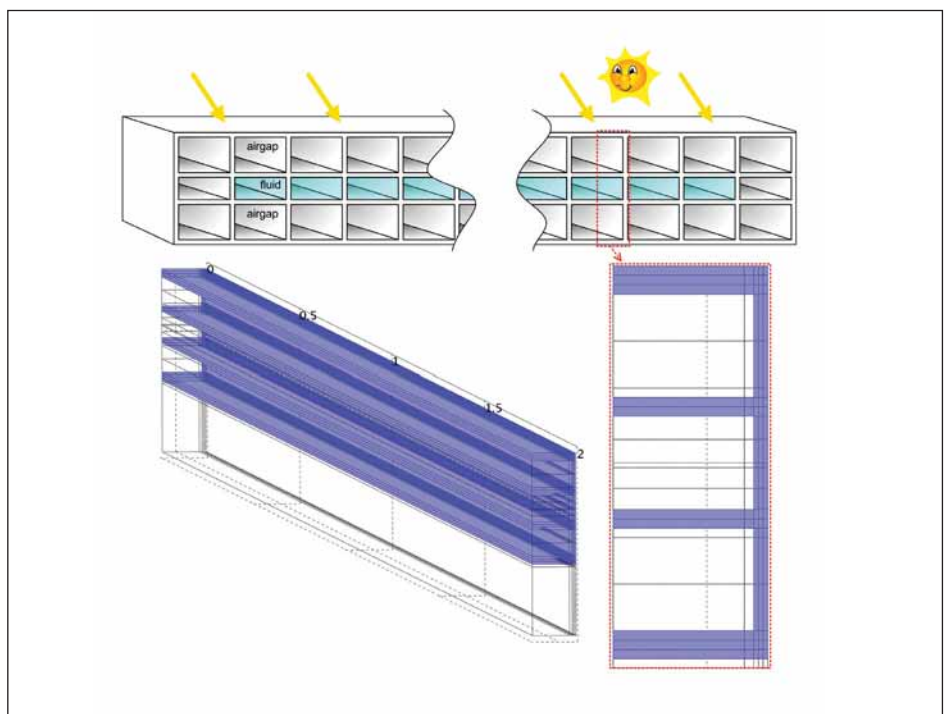

Figure 1: One possible geometry for a solar absorber made of polymer materials.

contact area between the absorber and the heat-transfer fluid. With solar collectors, heat transfer is certainly dependent on a material's thickness and heat conductivity. But an even more predominant effect can be the heat-transfer coefficient between the fluid and the wall, which is determined by the fluid dynamics in the vicinity of the surface, and they depend on the surface's shape. Because polymeric materials can have almost any form, we want to optimize a polymeric absorber's shape so that heat transfer by convection overcomes the lack of heat conductivity.

Advantages of design optimizations are best described by the results of adding an additional plate as absorber into the design, which could increase the internal conductance from 95 W/m<sup>2</sup>K to 540 W/m<sup>2</sup>K.

Figure 1 shows one possible layout for a thermal absorber based on multi-wall sheets where the heat-transfer fluid passes through channels that are surrounded by channels filled with air to provide heat insulation from the environment.

### Stress Level Analysis of Collector Designs

However, collectors deform when heated, so stress distribution and deformation represent potential risks for their stability and durability, especially at mechanical connection points. We want to estimate a product's useful lifetime due to mechanical stresses that arise not only during normal operation but also during stagnation, the worst-case situation when the energy storage is no longer able to take heat from the collector. We set up a COMSOL model that accounts not only for the tempera-

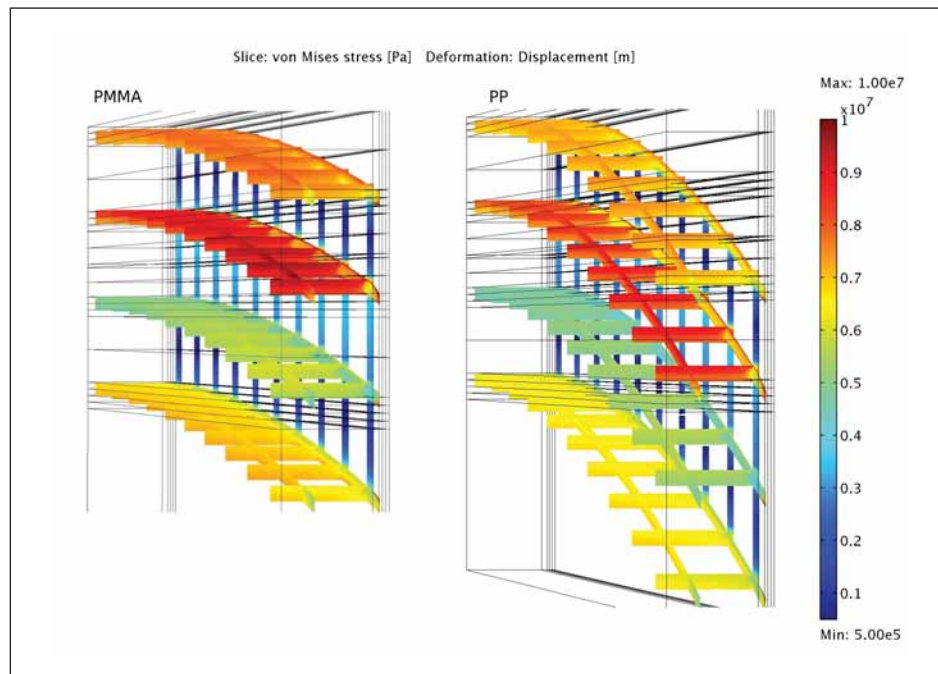

Figure 2: The Von-Mises stresses within a polymer-based solar collector at a normal inlet temperature of 350 K can vary widely depending on the material; here a comparison of the stresses and deformation between polymethyl methacrylate (left) and polypropylene (right) is shown.

ture distribution that varies with the position of the absorber layer but also other factors that affect the temperature level including the amount of irradiance, inlet temperature and the collector's thermal losses. This temperature data enables the determination of the collector's deformation and mechanical failures shortening the service lifetime (Figure 2).

### Humidity Transport in PV Modules

While the previous model dealt with solar collectors, polymers also play a role in improving the cost efficiency of photovoltaic (PV) solar modules. These consist of a front cover of glass, encapsulated so-

lar cells and a back-sheet, which is usually made of polymeric materials. These polymeric back-sheets and encapsulants provide a barrier to keep humidity, atmospheric gases and pollutants away from the silicon solar cells and protect them mechanically. The ingress of humidity is a serious reason for their degradation, which can hardly be measured without physically destroying the module. Therefore, we work on developing measurement technologies and the mathematical modeling of the humidity transport.

### Modeling Benefits

Thanks to our modeling, we can compare different polymeric collector geometries and materials for various energy carriers to reach an optimized collector design in terms of efficiency and price. We have also confirmed that our design is as efficient as conventional collectors and that the mechanical stability is sufficient if the collector is constructed properly. Our next steps are to model longer time periods to guarantee sufficient durability for our future partners in industry. ■

READ THE RESEARCH PAPER AT:  
[www.comsol.com/papers/5649/](http://www.comsol.com/papers/5649/)

### About the Author

Karl-Anders Weiss earned his degree in physics and economics at the University of Ulm, Germany. Since 2005 he has been with the Fraunhofer Institute for Solar Energy Systems in a group focusing on durability analysis and environmental engineering.



Fraunhofer researchers studying the COMSOL simulation results are (left to right) Georg Mühlhöfer, Karl-Anders Weiss, Jochen Wirth, and Philip Hülsmann. Steffen Jack is missing.





# Ugitech Optimizes Steel Casting Process Using COMSOL Multiphysics®

BY CHRISTIAN DEVILLE-CAVELLIN, UGITECH S.A., UGINE, FRANCE

In any industrial process, one key goal is to optimize speed. For Ugitech S.A., a manufacturer of stainless steel in France, that means running its continuing casting machines as fast as possible while maintaining quality. Yet, if you cut off individual pieces from the square bloom coming out of the casts prematurely, the inside of the steel section will not completely solidify, and a molten metal well with as much as 1.5 tons of liquid steel can empty into the bottom sections of the vertical concast machine, causing major damage. Through modeling, Ugitech is optimizing the proper temperatures and process speeds for each of the 150 different steel grades the company produces.

## A Solidified Shell Forms First

In our casting process, molten steel enters a tapered copper tube mold that is intensely cooled by external water circulation. During this stage, a solidified shell forms that can withstand the ferrostatic pressure from the molten metal well inside the strand. After the mold, three series of water sprays keep on increasing the strength of the shell, while rollers prevent it from bulging. The strand is finally cooled through radiation; see Figure 1.

One modeling investigation concerns early solidification, which can lead to cracks, segregations near the product's skin, depressions and oscillation marks (the mold oscillates vertically to help the mold effect lubrication). As the shell cools, it shrinks and an air gap forms at certain points; see Figure 2. That gap's location has a big impact on the final product, and controlling its proper level is a delicate process. If the gap opens too early, insufficient heat is removed from this part of the shell, the solid skin re-

mains thin, and internal defects appear in the product. If the air gap is too thin, the mold becomes too conical and friction arises between the strand and the copper mold, which may cause a shell breakout below the mold, due to excessive friction during the extraction process.

Only with multiphysics modeling is it possible to understand what is happening inside the steel bloom as it passes through the concast machine. Using COMSOL Multiphysics® along with the Heat Transfer Module and the Structural Mechanics Module, to compute the skin

deformation during the solidification process, it took us roughly 6 months of time to develop the model and verify it against experimental data.

## Contact Conditions and Phase Changes

The model actually consists of two parts. Firstly, a pure heat-transfer model that can predict temperatures and phases within the bloom and then a thermomechanical model that will help us better understand the mold/steel interface and explain certain defects on the bloom surface in order to correct them; see Figure 2.

Part of the challenge in setting up the model is due to the strong nonlinearity of the contact condition between the steel and the mold. In addition, the steel undergoes phase changes. For this, it is necessary to find thermo-physical data about each steel grade and include it in the models. For example, we can directly include in COMSOL a description of thermal conductivity using a 3rd-order polynomial,

## Author Biography:

Dr. Ing. Christian Deville-Cavellin is the Head of Liquid Metal Metallurgy/Solidification Dept. at Ugitech S.A.'s Research Center in UGINE, France.



Intro

Gov

ToC



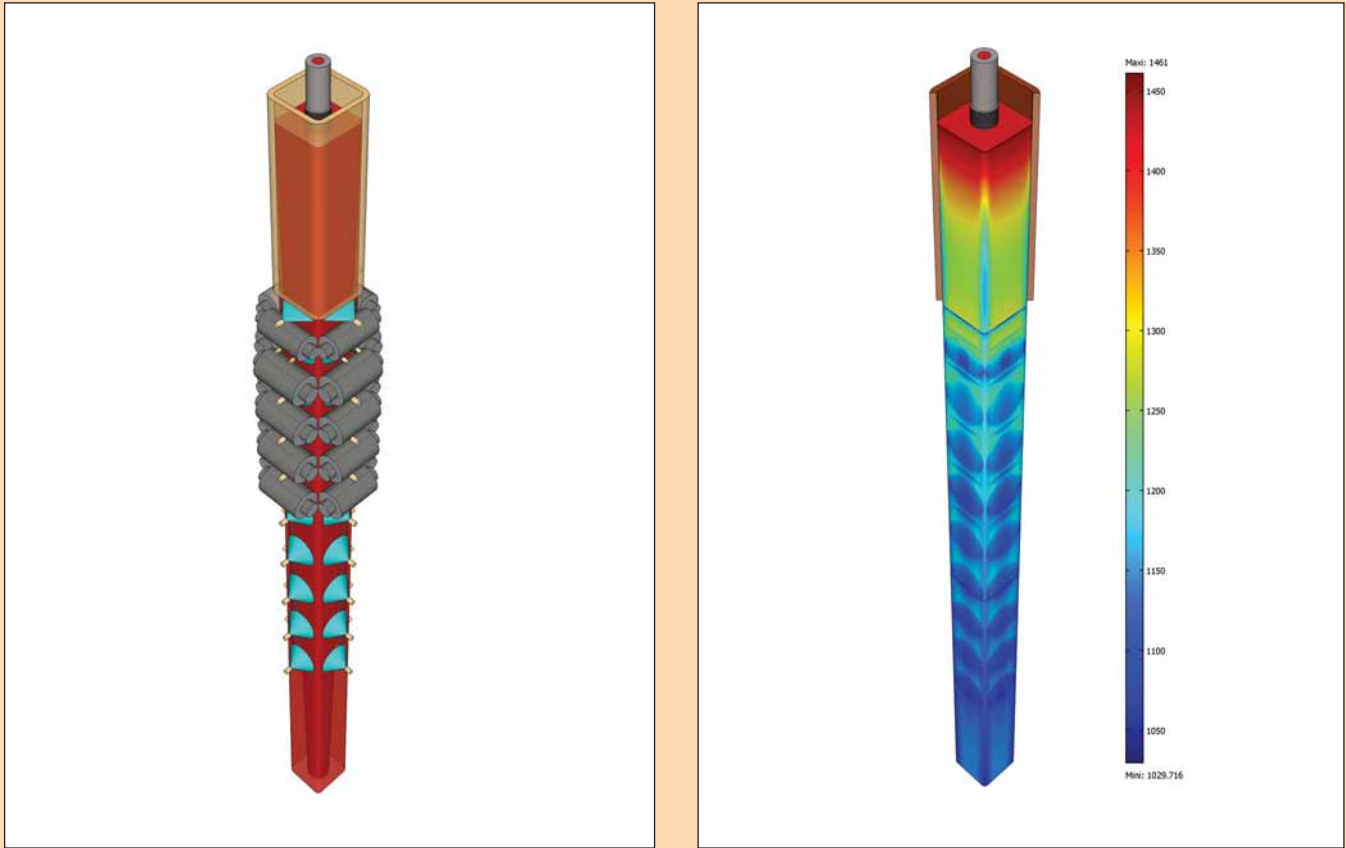

Figure 1: Depiction of the casting process. Liquid metal enters a water cooled mold where cooling and solidification occurs through convection and conduction. Once a solid shell (the skin) has developed, this is cooled through a series of water sprays before cooling is allowed to occur naturally through radiation. The length of the liquid well is critical to the point where the cast can be torch-cut. The temperature profile is also shown.

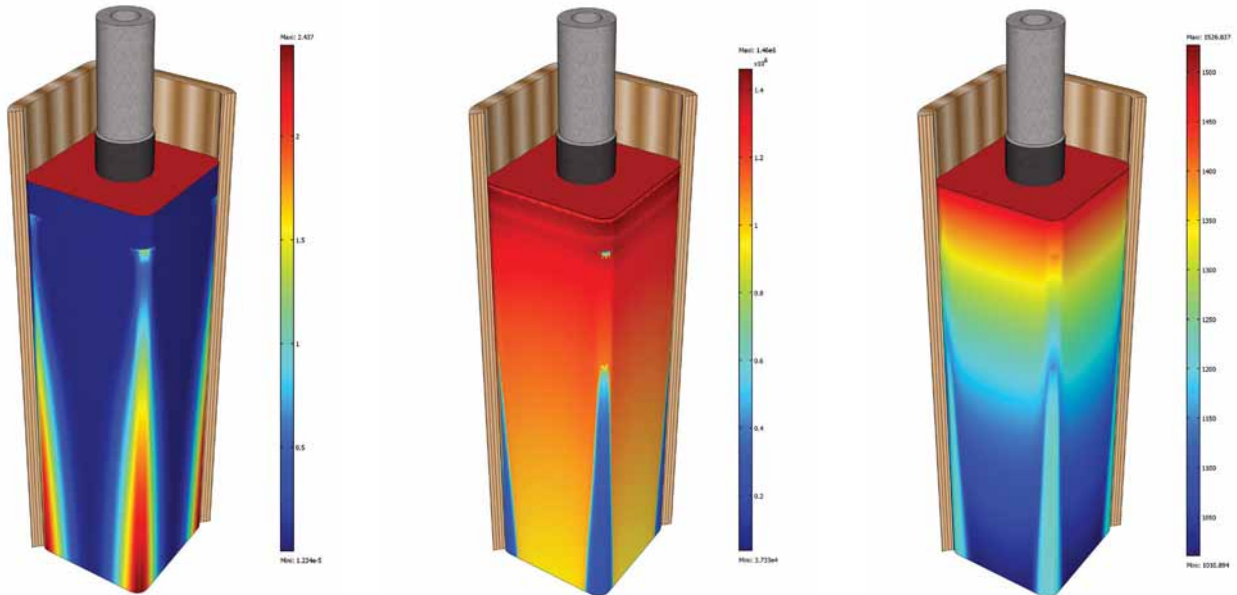

Figure 2: The model is used to examine the development of the air gap (left), the heat flux inside the bloom (middle) and the temperature in the bloom (right). The air gap not only affects the heat flux and cooling of the cast, which is to be expected, but also has a significant effect on the product surface quality.



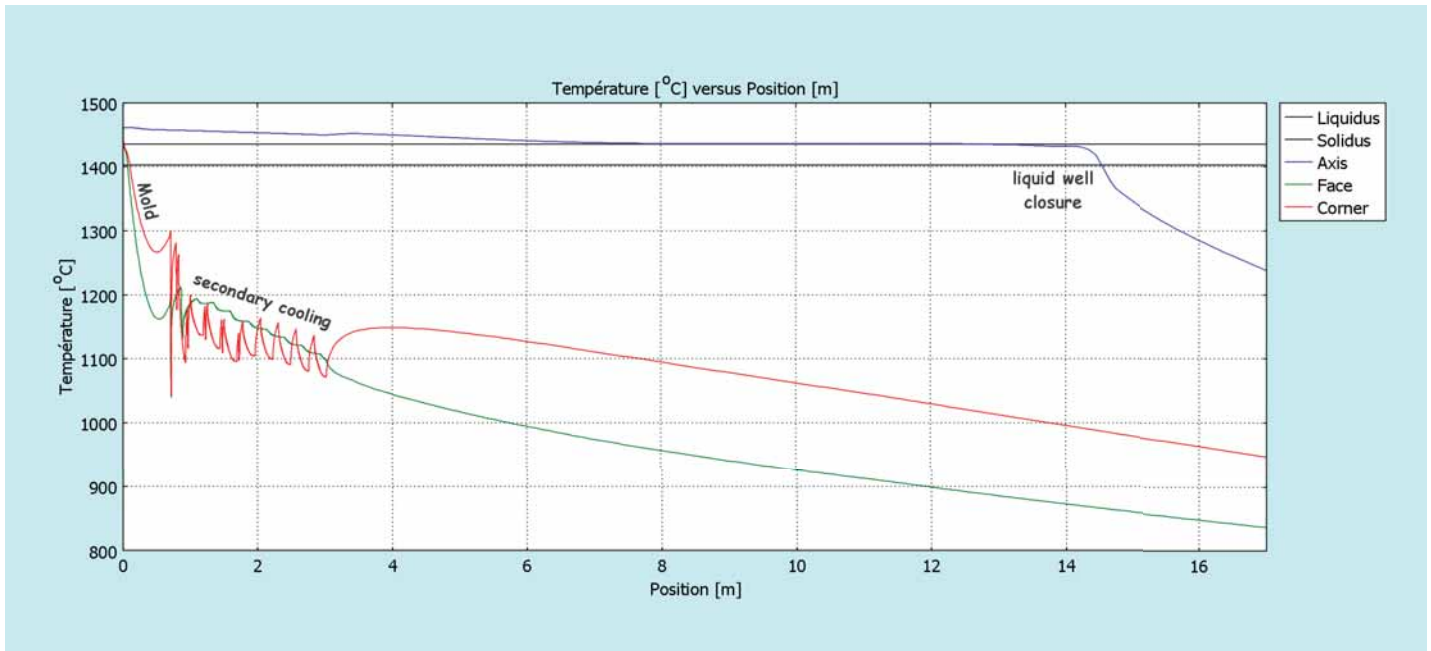

Figure 3: Torch cutting of the strand can take place only after the metal in the center of the bloom has solidified.

based on years of experimental data, but where in one critical temperature range, we instead include a table of 40 to 100 data points and let COMSOL extrapolate between them.

We spend a great deal of time with the model studying various cooling aspects, again to increase process speed without impacting product quality or to change the properties of the end product. This is a delicate matter, and we don't want to experiment with our customers. In some markets, such as the automotive and nuclear industries, end users run their own trials and certifications on the steel. Thus, making a process change takes considerable thought and planning, and the model is extremely helpful in giving us understanding and revealing possibilities.

With the model we can also assess modifications to the machine. One time, the production engineers asked us to study the secondary cooling section, which they wanted to move just a few centimeters for accessibility and maintenance purposes. Even a small change could have a major impact on the process, and it's not something you want to experiment with on such expensive machinery. With the model we were able to confirm that it was OK for the process team to move the cooling section without any serious consequences.

In another case, the model helped avert a major problem. The production staff wanted to make the torch-cut with what they thought was over a 1 m security limit for solidification. Our model showed that this would actually result in a premature cut and would open up a molten metal well, with the catastrophic consequences that this would entail. We ran the simulation with COMSOL, and we are now able to readjust the security limits much more accurately; see Figure 3.

### Choosing COMSOL Multiphysics®

We selected COMSOL after a review of other simulation products and found that it provides the leading performance for a third of the price. We already have specialized software for mechanical engineering, and had to convince management that it would be a good investment for a multiphysics tool. We wanted a general-purpose tool that we could apply to a variety of problems. The initial project involved finding the temperature profile of a moving wire inside a heated tube. Using COMSOL Multiphysics, we found this profile and were able to convince management that we could perform such modeling easily and in a short time.

We have meanwhile found new ways of implementing and solving problems with

**“With this approach we become much more productive than with any other simulation software.”**

this package, mostly due to the power it provides through us being able to add any physics to our models. With this approach we have become much more productive than with any other simulation software. These first results have given our process engineers some new ideas, as well as creating new questions, and it has encouraged them to imagine new ways for solving problems.

More and more people at Ugitech are considering the benefits of increasing our simulation effort. People are not asking me questions of the type “can you calculate that?”, but rather “what happens when... or if...?” We have also found COMSOL Multiphysics very useful in communicating ideas and concepts to our customers. ■

READ THE RESEARCH PAPER AT:  
[www.comsol.com/papers/4917/](http://www.comsol.com/papers/4917/)



Intro

Cov

ToC



# Qualifying COMSOL® for Nuclear-Safety-Related Procedures

Oak Ridge National Laboratory approves COMSOL Multiphysics® software for use in their High Flux Isotope Reactor facility.

BY CATHLEEN LAMBERTSON

The Department of Energy’s (DOE) Oak Ridge National Laboratory (ORNL) High Flux Isotope Reactor (HFIR) is the highest-flux reactor-based source of neutrons for condensed-matter research in the US. Thermal and cold neutrons produced by HFIR are used to study physics, chemistry, materials sci-

ence, engineering, and biology, as well as to produce unique radioactive isotopes for industry and research. As mandated by the DOE, ORNL must perform software quality assurance (SQA) procedures with special attention to nuclear-safety-related software applicable to the HFIR. The SQA process is performed to assure that the software used to perform an analysis is producing the intended results. The DOE requires that all software in their facilities satisfy a graded approach

to SQA. For software used to perform nuclear-safety-related analysis, these requirements can be more extensive. James D. Freels, Ph.D., a senior research staff member in ORNL’s Research Reactors Division (RRD), is a co-developer of the SQA procedure (called SBP-1300) for implementing these DOE-mandated

## Nuclear-Safety-Related Applications

COMSOL is currently undergoing review at ORNL’s HFIR facility to perform nuclear-safety-related applications. Dr. Freels said, “COMSOL has become a principal code that is being used for some very important, safety-related design and safety calculations for RRD, and hence, for DOE. In order for the calculations to be approved by the RRD, the software QA must be in place.”

Examples of the equipment at the HFIR facility that COMSOL would be applied to designated as nuclear-safety-related include safety plates that get inserted when the reactor needs to be shut down, pipes or valves that need to operate to keep the facility safe, or fuel plates that contain the nuclear fuel. “Any of this [nuclear] safety-related equipment being analyzed with a computer code has to have a corresponding safety-related calculation that goes along with it,” said Dr. Freels. “What makes a safety-related calculation different is that, not only does it go through a formal check and review process, but it also requires another independent review. The independent review process

“COMSOL has become a principal code that is being used for some very important, safety-related design and safety calculations.”

ence, engineering, and biology, as well as to produce unique radioactive isotopes for industry and research. As mandated by the DOE, ORNL must perform software quality assurance (SQA) procedures with special attention to nuclear-safety-related software applicable to the HFIR. The SQA process is performed to assure that the software used to perform an analysis is producing the intended results. The DOE requires that all software in their facilities satisfy a graded approach

SQA requirements. Dr. Freels said, “The procedure was approved for use on June 6, 2001. I developed the procedure along with Max Gildner, a QA specialist and also an employee of ORNL. Since that time, there have been approximately 51 separate computer codes approved through this procedure on about 30 separate computers.” Recently, he applied SBP-1300 to COMSOL so that nuclear-safety-related calculations may be performed using the COMSOL Multiphysics software.

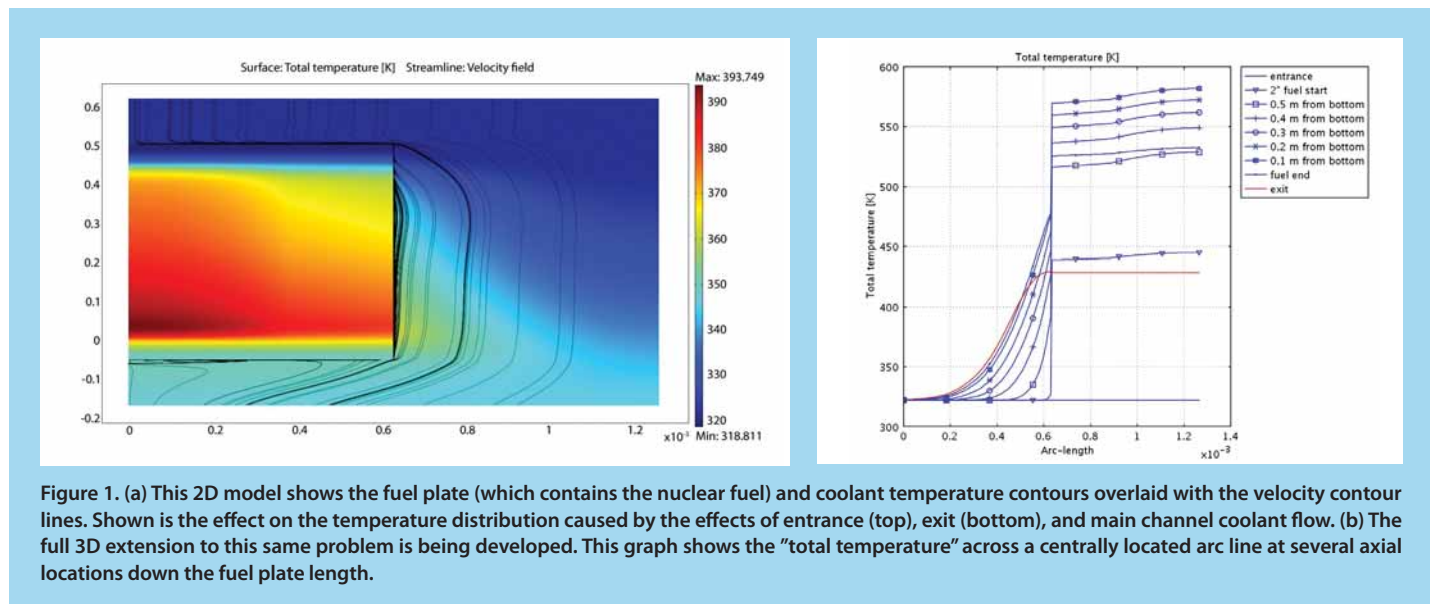

Figure 1. (a) This 2D model shows the fuel plate (which contains the nuclear fuel) and coolant temperature contours overlaid with the velocity contour lines. Shown is the effect on the temperature distribution caused by the effects of entrance (top), exit (bottom), and main channel coolant flow. (b) The full 3D extension to this same problem is being developed. This graph shows the “total temperature” across a centrally located arc line at several axial locations down the fuel plate length.





Senior nuclear safety analysts at HFIR are (left to right) Cliff Hyman, Jim Freels, Fred Griffin, and Trent Primm. Freels holds a slice of an inert HFIR inner fuel element showing several of the involute-shaped fuel plates attached together. In front is a full-scale mockup of an entire HFIR fuel element assembly.

strongly encourages an alternative calculation be performed, or better yet, a test or experiment be performed to demonstrate the validity of the calculation.”

### The SQA Procedure

The verification that a specific software code is installed and producing the results expected by the developer is the main focus of the SQA procedure. “What we do in our SQA procedure is just the verification step. [We] take out representative problems from the software manuals that are typical of what we do here and run those on our computer and verify that we get the same results that are intended by the code developers,” said Dr. Freels. “For COMSOL, because it is a multiphysics code and we want to use it for many applications, it is important to try to cover a broad range of verification problems over which to document the SQA. Therefore, it takes a little longer to both create the SQA documentation and to perform the review. It takes about a man-month to perform both steps on average for this first time.”

In addition to the representative problems extracted from the COMSOL manual (the results of which were found to be identical), Dr. Freels created two additional problems to perform the SQA. These two problems were developed to verify both the finite-element convergence rate and the parallel-processing performance of COMSOL. The problems are typical of what might be analyzed at HFIR.

According to Dr. Freels, finite-element convergence is a special quality that

gives the user a desired numerical accuracy with the minimal level of resources required (number of nodes, amount of memory, CPU time, etc.). The convergence curves also give the user an idea of what level of noding to stop at to achieve a given level of accuracy (see Figure 2). “The convergence rate exhibited by COMSOL follows the expected pattern of a finite-element based code. This means that COMSOL truly is a finite-element based code. Many of the popular CFD codes would not be able to do this because they are not finite-element codes,” he stated.

Parallel processing can be categorized into shared-memory and distributed types. “Presently, COMSOL can utilize shared-memory parallel processing. A future COMSOL version will include both shared-memory type on each cluster node, and then distributed across multiple cluster nodes,” explained Dr. Freels. Both shared-memory and distributed types of parallel processing require a certain level of overhead (wasted processor time). “A perfect parallel processing code would have a speed-up factor equal to the same number of processors. The speed-up achieved for COMSOL is shown by Figure 3.

The RRD recently acquired a new computer that has eight processors per node. “This has allowed me to generate a larger table and more meaningful results for COMSOL than what was done last fall for the Boston Conference, which used only four processors. We found that the speed-up increase reduces in moving from the first processor four cores to the second

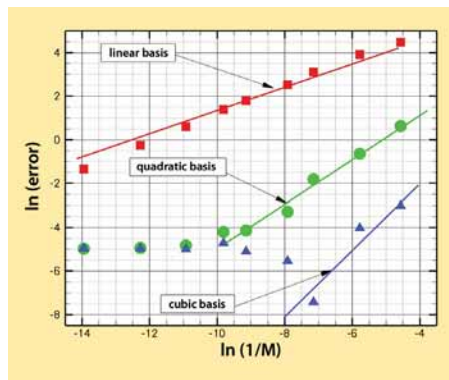

Figure 2. Convergence curves provide an idea of what level of noding at which to stop to achieve a given level of accuracy. The convergence rate exhibited by COMSOL follows the expected pattern of a finite-element-based code.

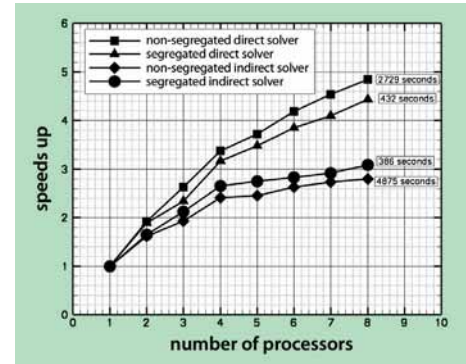

Figure 3. A plot of speedup (y-axis) versus the number of processors (x-axis). The slope of the line dramatically changes after four processors because there are two separate processors and four cores per processor, and the data transfer between the processors is slower than between the cores. The CPU time required to complete the job with eight processors is shown at the end of each curve. Even though the speed-up is lower, the segregated indirect solver is much faster than the other solvers.

processor of four cores. Thus, for a given problem, adding more shared-memory processors will eventually not significantly increase the turnaround for the problem,” said Dr. Freels. “We are expecting a new version of COMSOL to be out this year, enabling us to use multiple nodes of our 9-node cluster and be able to use up to 40 processors at a time when running COMSOL. Such a distributed parallel processing capability will likely produce a much different efficiency. It will be very interesting to see what type of configuration is optimum for running COMSOL.”

### What's Next?

Along with the new computer, the RRD recently received a new version of COMSOL; therefore, the SQA procedure for nuclear-safety-related applications is once again being repeated. “We will qualify COMSOL for all the conceivable uses we have here in RRD. I think the opportunity for COMSOL at ORNL is tremendous. I am absolutely amazed at the breadth of applications that are being simulated with COMSOL,” said Dr. Freels. “I can foresee that all the existing COMSOL modules could be fully utilized at ORNL, and perhaps new modules developed in the future.” ■

READ THE RESEARCH PAPER AT:  
[www.comsol.com/papers/5187/](http://www.comsol.com/papers/5187/)

# Analysis of Unique Loudspeaker Driver Possible Only with Multiphysics Modeling

BY ROD HABESHAW, SFX TECHNOLOGIES LTD.

While we traditionally think of loudspeakers as separate boxes, we at SFX Technologies Ltd. (Dunfermline, Scotland) are using COMSOL Multiphysics® to help us design a new type of loudspeaker driver that uses virtually any surface — from a tabletop to walls, mirrors, dashboards, billboards or even bus shelters — to produce high-quality sound. When a GA (Gel Audio™) transducer is placed against a surface, this becomes the loudspeaker. It's virtually impossible to model this complex process on a theoretical basis on paper, which makes it a perfect candidate for numerical simulation. After having worked with several modeling packages, we found that COMSOL Multiphysics offers the combination of features and usability that most closely matches our requirements.

## Gel as the Interface

Our speaker technology is quite unique: users mount a GA transducer in permanent contact with a panel without being bonded to it, such as with two-sided adhesive tape. The transducer's magnet and coil receive analog audio signals from an amplifier, and the gel acts as an intermediary material that transfers the acoustic waves to the panel. Being as small as 11 x 16 x 2.5 mm, the result is a "speaker" with good high-frequency response with

the added advantage of also generating very good bass response without the need for a large speaker box.

GA transducers were initially popular in places where you don't want speakers to be visible or accessible, such as in a bus stop or public-address systems. Now, though, they are being incorporated into products such as small TVs so that you achieve very good bass response without

requiring a subwoofer. We are also looking at putting them into mobile phones for better audio response. In these cases, it is difficult to test prototypes because handset manufacturers have tight time-to-market schedules. Simulation results can show them what they can expect when drivers are incorporated into their phones so that development can simultaneously proceed on both the phone and the driver.

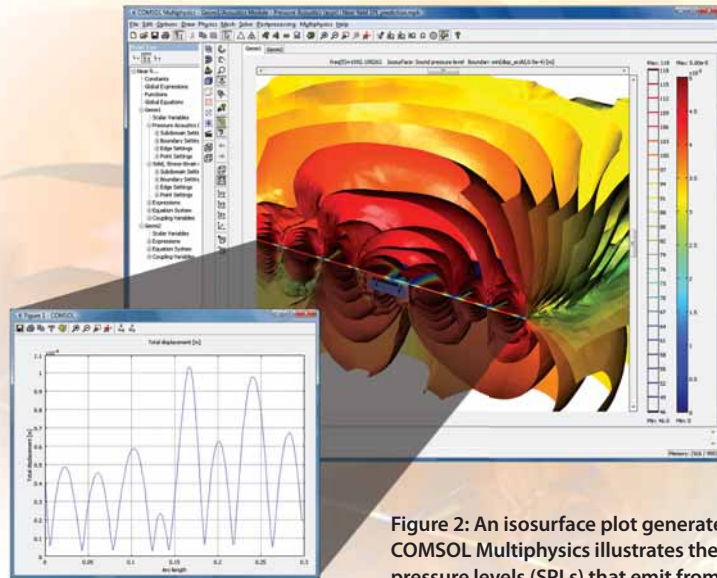

Figure 2: An isosurface plot generated with COMSOL Multiphysics illustrates the sound-pressure levels (SPL) that emit from a typical panel surface when driven with the Gel Audio™ transducer. Here the results are shown for one frequency (1092 Hz), while the graph shows the extent of surface displacement.

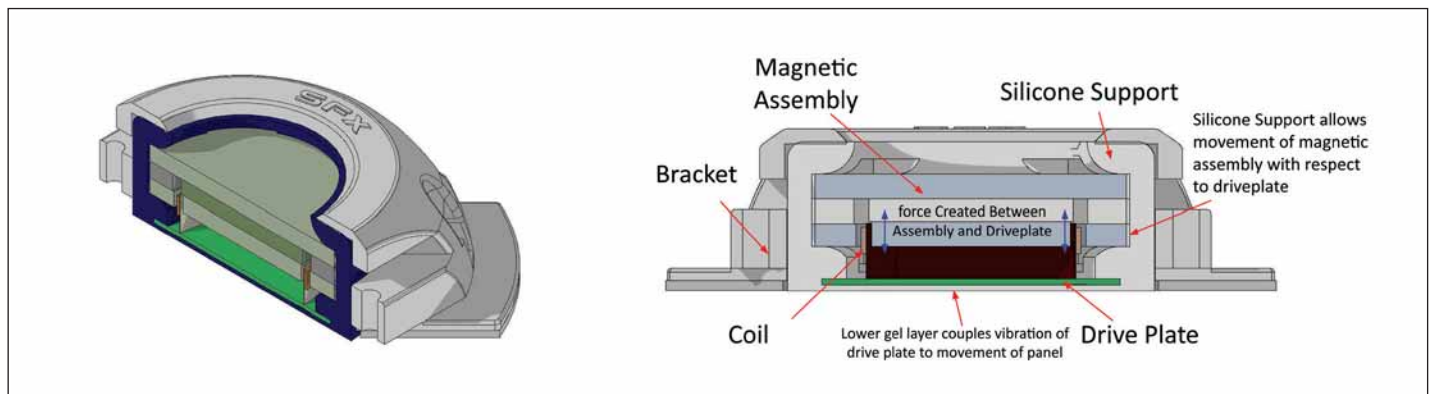

Figure 1: When placed on a panel such as a wall, mirror or dashboard, a Gel Audio™ transducer turns that surface into a loudspeaker with good frequency response across the audio range.



“After having worked with several modeling packages, we found that COMSOL Multiphysics offers the combination of features and usability that most closely matches our requirements.”

Previously, it would take us three months to build an initial prototype of a new design whereas now with simulation, which is now being done with COMSOL Multiphysics and the Acoustics Module add-on, our design team can achieve a first prototype within a month. This time difference is vital for this new technology as we at SFX want to get our devices on the market quickly, especially as we expand from the commercial arena into consumer products.

### Complicated Route to Simple Results

The modeling process takes place in three major stages. First we create a model of the coil and magnet to determine the forces that are generated at all frequencies. We next take these results and use them in a simulation of the panel to obtain its deformation and acceleration across the frequency band of interest. In the final step, we simulate the acoustic field that the panel would generate. Although we model intricate movement of the loudspeakers, the result we want from the simulation is relatively simple: a plot of the sound pressure level coming from the loudspeaker versus frequency. Getting to this result, however, requires a complicated route.

Simulation is first necessary to size the various mechanical components, such as the coil and magnet in the driver, and examine their effects. Further, while those two components produce

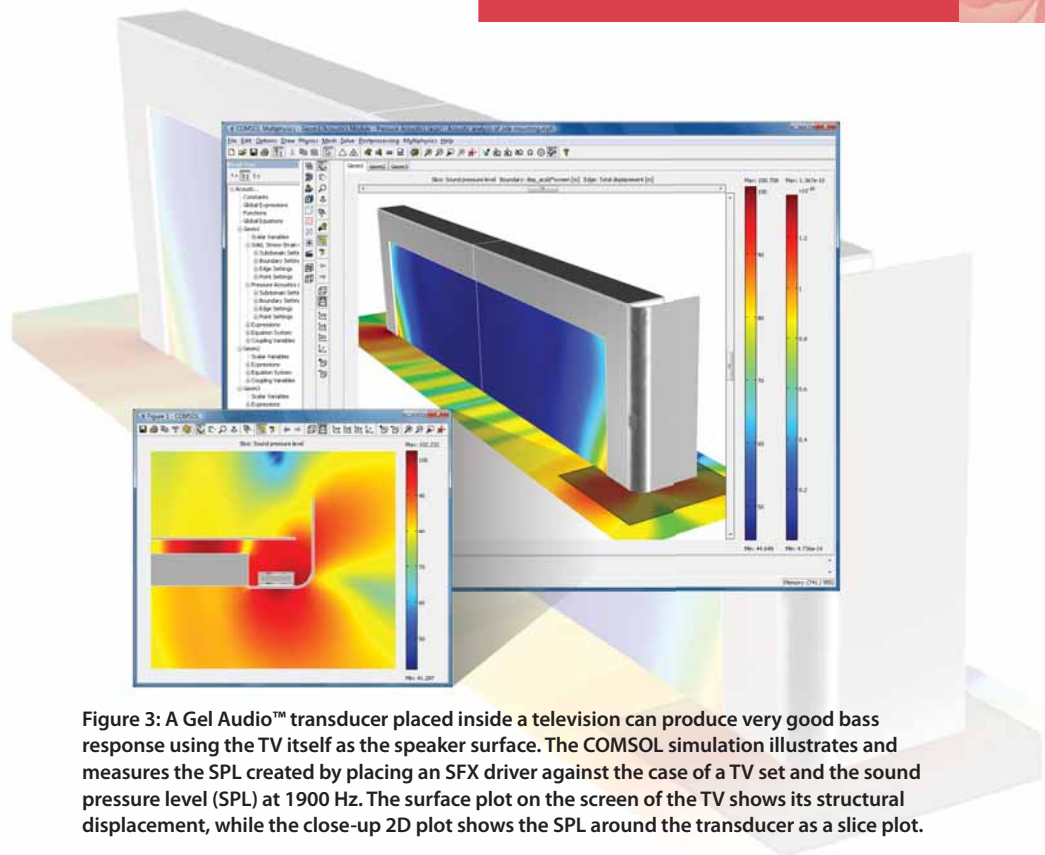

Figure 3: A Gel Audio™ transducer placed inside a television can produce very good bass response using the TV itself as the speaker surface. The COMSOL simulation illustrates and measures the SPL created by placing an SFX driver against the case of a TV set and the sound pressure level (SPL) at 1900 Hz. The surface plot on the screen of the TV shows its structural displacement, while the close-up 2D plot shows the SPL around the transducer as a slice plot.

unidirectional movement, the panel on the other side of the gel can produce a very complicated waveform, especially at high frequencies, consisting of movement that might lead to sound distortion and modal shapes that change with frequency.

So a primary task of the modeling is to find the optimal assembly — the right amount of gel and the best way to attach it to the surface — and doing so by considering structural-acoustic interactions. Too much gel makes the driver inefficient and nonresponsive; too little leads to sound distortions.

Initially our design group employed an FEA software that loosely couples structural mechanics to acoustics iteratively. But this made modeling the acoustics domain an elaborate operation and didn't really allow us to model what we wanted. We were therefore pleased to find out that we can do all this work in a straightforward manner using COMSOL Multiphysics Version 3.5a. And things just got better using the new predefined multiphysics coupling template between the Solid, Stress-Strain and Pressure Acoustics modeling templates in the Acoustics Module.

### Every Case Unique

COMSOL proves to be very useful for us at SFX because almost every design we consider is unique; we work with a wide variety of panels and panel materials, and for each, a different driver and mounting is required. For instance, the panel that acts as the loudspeaker might be made of plastics, various rubbers and elastomers, or composite materials such as cardboard. In this case, our modelers improvise by representing the panels with isotropic materials.

Besides using COMSOL Multiphysics for all of our new speaker designs, we are also examining new ways of shaping panels, where modeling provides an understanding of the involved phenomena as well as concrete design parameters. In addition, we are also starting to combine traditional loudspeakers and GA transducers in the same system. Modeling is essential in these efforts where the acoustics-structure interaction from both devices, and their effects on each other, must be considered.

*Gel Audio™ is a trademark of SFX Technologies Ltd. COMSOL Multiphysics is a registered trademark of COMSOL AB. ■*



## Hi-Fi Hearing Aids with Multiphysics Modeling

The need for hearing aids is growing, and manufacturers are coming up with new technologies to make these devices more attractive and effective. COMSOL® proved very useful due to its ability to easily handle arbitrary equations and provide another dimension to our integrated signal processing model.

BY MADIS J. HERRING JENSEN, WIDEX A/S

**W**ith the Baby Boomer generation now reaching retirement age, it should be no surprise that the number of people who suffer from hearing loss is increasing. The American Academy of Audiology estimates the number of Americans in that situation at 36 million. It also adds that more than half of the people with hearing loss are younger than 65, with approximately 12% of all children aged 6 to 19 have noise-induced hearing loss. Many of these people are candidates for hearing aids.

Meeting the demands of these markets, hearing aids are becoming more effective and less obtrusive. With a BTE (behind the ear) model, a tube connects the electronics-based module to an ear mold located within the ear channel. Some small amount of amplified sound inevitably leaks out from around the ear mold, and if the hearing aid is not properly designed, this sound can be picked up by its microphone and lead to squawks and other feedback effects. In addition, sound radiating through the tubing can also lead to feedback. To eliminate these effects, designers are looking for improved materials for the tube, optimal placement of the microphones as well as feedback algorithms that reduce the gain at critical frequencies.

**“We can add details that are extremely difficult to acquire experimentally, including radiation from the earmold and earmold tube and internal structural vibrations.”**



Figure 1: A BTE (behind the ear) hearing aid transfers sound through a plastic tube to an ear mold that fits into the hearing channel. Note the two microphone inlets on each unit (arrows).

### Working Towards Better Hearing

A privately-owned company and with a world market share of approximately 10%, Widex has always devoted considerable resources to R&D. Now more than 50 years old, Widex has roughly 1,850 employees around the world. In 1997 we launched the world's first fully digital CIC (completely in the canal) hearing aid; in 2006, our Inteo was the first hearing-aid line with integrated signal processing.

Modeling has made a major contribution in the stability and robustness of our feedback algorithms because of the greater insight we get from modeling with COMSOL. Previously, the feedback algorithm was based on experimental measurements made in test setups using the hearing aid's two microphones. However, many aspects must be considered to determine the optimal algorithm — including the shape of the pinna (the projecting outer portion of the ear, also known as the auricle) and the location of the hearing aid on the ear. We can

add details that are extremely difficult to acquire experimentally, including radiation from the earmold and earmold tube and internal structural vibrations. And while today all models in a given product line use roughly the same feedback algorithm, in the future it might be possible to scan an individual's ear area and use mathematical modeling to design an individualized feedback algorithm.

### Modeling Thermoviscous Acoustics Behavior

We found COMSOL Multiphysics® to be particularly useful in our studies, which are based primarily on thermoviscous acoustics, because the underlying equations are not standard in any commercial simulation package we are aware of. Thus, COMSOL's ability to let us incorporate our own systems of equations was vital for the development of our hearing-aid models. In addition, the freedom to specify arbitrary boundary conditions was very useful.



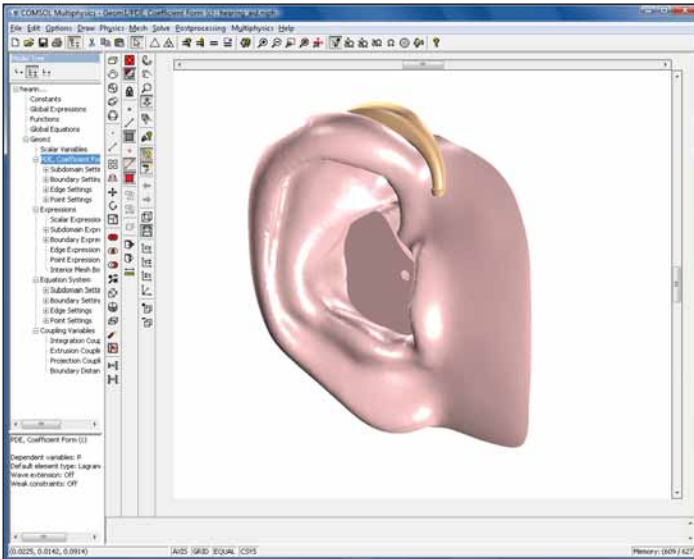

Figure 2: The geometry imported from Pro/ENGINEER® of the ear and hearing aid in the COMSOL Multiphysics. The vent hole in the ear mold is seen in middle of the ear canal.

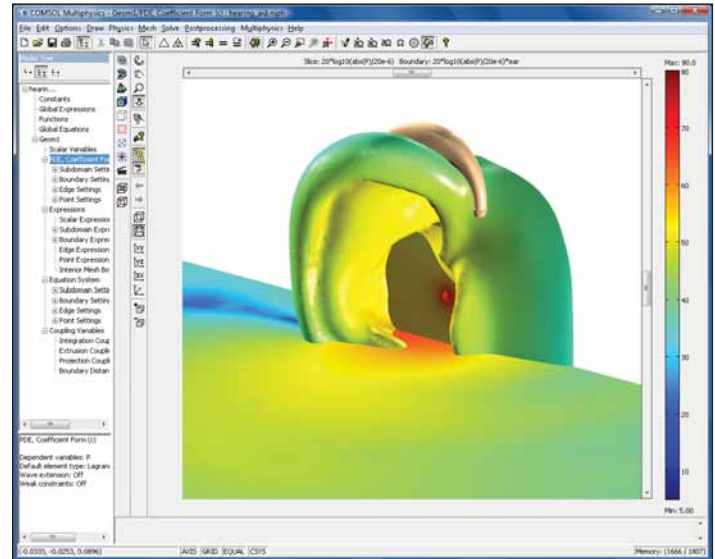

Figure 3: A COMSOL slice plot helps evaluate the ear's shadow effect at 1 kHz. The "shadow" is evident behind the ear.

After using the CAD Import Module to read in the Pro/ENGINEER® CAD drawings supplied by our mechanical design department, we set up the problem in

COMSOL's PDE mode. Once we get the COMSOL results, we transfer them to a specialized simulation and algorithm-development environment we have created that is based on

MATLAB®. We have found very close agreement between sound-pressure plots from hearing aids using these algorithms and test setups we have constructed using plastic ears.

have a tool that allows us to better study the shadow effects of the ear, whereby sound from certain directions is blocked to some extent. We are also using modeling to find the best location of the ear mold's vent hole, which is added to prevent unnecessary attenuation of low frequencies and occlusion. This is when users feel a sense of pressure or blockage whereby they hear themselves (like a singer who places a finger in their ear when performing), hear echoes or even finding chewing food noisy and unpleasant.

## About the Author

Dr. Mads Jakob Herring Jensen has been working in the audiological research lab of Widex A/S (Vaerloese, Denmark) since 2006, and he has been using COMSOL for almost 6 years, first in the field of microfluidics and more recently to implement a thermoviscous acoustic model. He got his MSc in Engineering from the Technical Univ. of Denmark (DTU), moved on to do research at Harvard Univ in the USA, and then returned to the DTU to receive his PhD in the Dept. of Micro- and Nanotechnology.

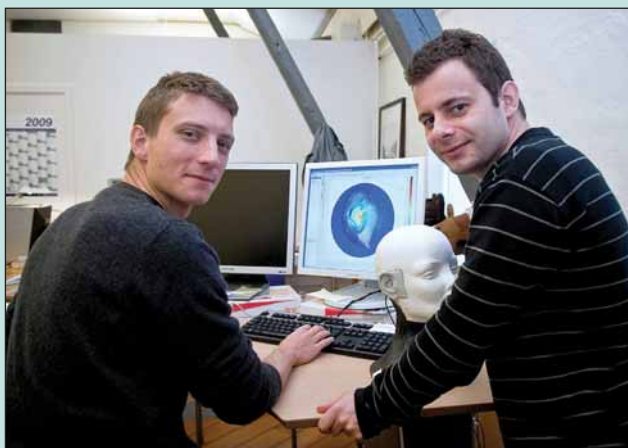

Mads Jensen (left) and his colleague Lars Friis working at both a virtual and live model of an ear and Widex hearing aid.

## Studying the Ear's Shadow Effects

With our modeling results, we are starting to improve certain hearing-aid features such as optimizing the hearing-aid's mechanical stability without leading to further feedback along with determining the best place to position the microphones. This has become possible as we now

## Developing a Comprehensive Model

Thanks to our studies with COMSOL, we are gaining a far better understanding of the acoustics of the ear in general, and how it affects the sound field that a hearing aid can measure. We can perform virtual tests on changes to the hearing-aid geometry, and the greater insights we gain into the physics of the system the better we can determine how various parameters interact. And while the current model includes only an ear on a flat surface, we hope that later models will include the entire head to see how it influences the incoming sound. ■

**READ THE RESEARCH PAPER AT:**  
[www.comsol.com/papers/5643/](http://www.comsol.com/papers/5643/)

COMING FALL 2009

# COMSOL MULTIPHYSICS® 4

The model tree gives you a compact overview of all the model settings.

Material selection sets relevant properties for all the physics defined in a domain.

The different steps in the model set up are available as features in the model tree. With the new interface you can also record sequences of steps for re-use.

Clicking on a feature gives you direct feedback on its settings. Here, clicking the Slice Plot feature in the model tree instantly shows the settings for the plot in a separate panel.

You can move, dock, and resize panels for easy navigation within the modeling environment.

The screenshot displays the COMSOL Multiphysics 4 software interface. On the left is the 'Model' tree, which lists various features such as Configuration, Constants, Expressions, Functions, Geometry, Materials, Physics, Mesh, Solver, and Postprocessing. The 'Slice Plot' feature is selected, and its settings are shown in the 'Settings' panel on the right. The settings include a plot name of 'Velocity field', a dataset of 'From parent', and a color table of 'Rainbow'. The 3D visualization on the right shows a velocity field with a color gradient from blue to red. At the bottom right, the 'Equation' panel displays the governing equations for the simulation.

$$\nabla \cdot \mathbf{u} = 0$$
$$\rho \frac{\partial \mathbf{u}}{\partial t} + \rho \mathbf{u} \cdot \nabla \mathbf{u} = \nabla \cdot \left( -p \mathbf{I} + (\eta + \eta_s) (\nabla \mathbf{u} + (\nabla \mathbf{u})^T) \right) + \mathbf{F}$$
$$\rho \frac{\partial k}{\partial t} + \rho \mathbf{u} \cdot \nabla k = \nabla \cdot \left( \left( \eta + \frac{\eta_s}{\sigma_v} \right) \nabla k \right) + \eta_s \nabla \mathbf{u} : (\nabla \mathbf{u} + (\nabla \mathbf{u})^T) - \rho \epsilon$$
$$\rho \frac{\partial \epsilon}{\partial t} + \rho \mathbf{u} \cdot \nabla \epsilon = \nabla \cdot \left( \left( \eta + \frac{\eta_s}{\sigma_v} \right) \nabla \epsilon \right) + C_{\epsilon 1} \frac{\epsilon}{k} \left( \eta_s \nabla \mathbf{u} : (\nabla \mathbf{u} + (\nabla \mathbf{u})^T) \right) - C_{\epsilon 2} \rho \frac{\epsilon^2}{k}$$

The equations and notations are displayed for transparency and documentation.



Intro

Cov

ToC





COMSOL V4 launches a brand-new graphical user interface that not only looks great, but increases functionality. This sleek design enhances usability because it concisely and directly reflects the powerful V4 multiphysics architecture. Now you can view, add, or edit any of your settings with a single click.

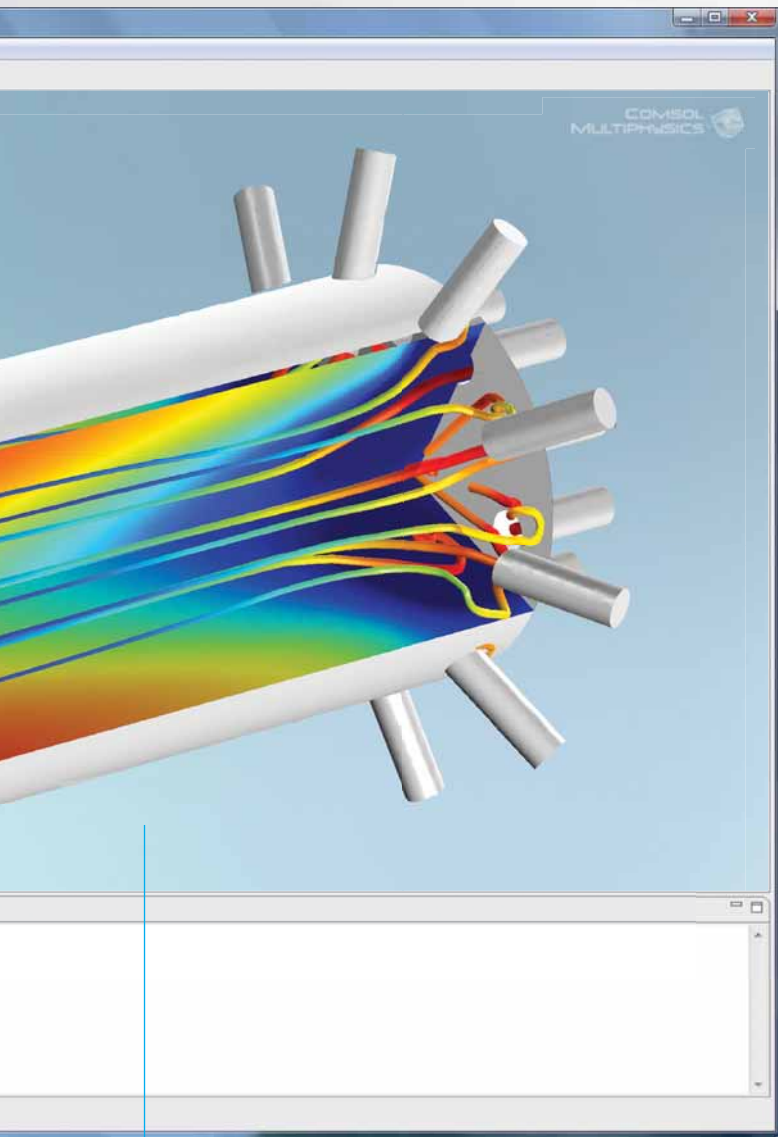

Screenshot preview of COMSOL Multiphysics V4 in development as of March 2009.

Select background color and include your own logo in the graphics area.

## NEW PRODUCTS PREVIEW

### CFD MODULE

A high-performance fluid dynamics package bringing industrial strength CFD and multiphysics together at last.

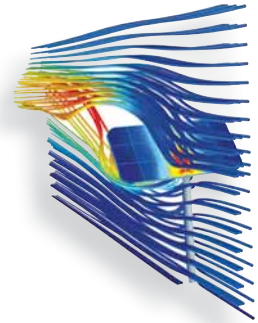

### ELECTROCHEMICAL ENGINEERING MODULE

A specialized module for modeling corrosion, electroplating, electrolysis, batteries, and fuel cells.

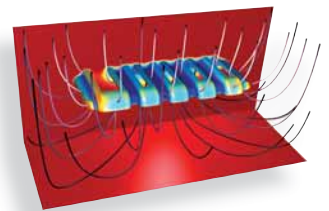

### PLASMA MODULE

A single product for the simulation of collective effects common in plasma applications such as display panels, semiconductor manufacturing, and rocket thrusters.

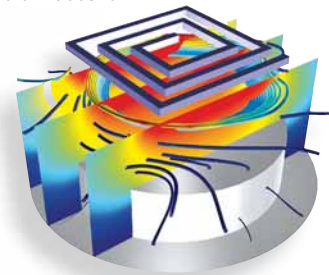

Intro

Cov

ToC



# ArcelorMittal Breaks Down the Physics of Corrosion

Automakers and other users of rolled steel know that a surface is well protected but have concerns at the edges when pieces are cut from a roll – and where paint delamination can start. Simulations are helping steel manufacturers determine which methods prove most effective in protecting edge cuts.

BY CHRISTIAN ALLÉLY AND TIAGO MACHADO AMORIM, ARCELORMITTAL, FRANCE

Steel makers have made great strides in developing products that resist corrosion. Even so, the US Department of Transportation published a study in 2002 that listed the total annual direct cost of corrosion at \$23.4 billion due to increased manufacturing costs, repairs and maintenance and corrosion-related depreciation of vehicles.

Automakers spend a great deal of time working with suppliers to come up with the most corrosion-resistant steel. It's no surprise, then, that the largest steel manufacturer in the world has a dedicated team devoted exclusively to the study of corrosion, ways to combat it and to develop new products — and

they've found that multiphysics modeling provides them with invaluable information towards this goal. This company is ArcelorMittal, which had revenues of almost \$125 billion in 2008, and crude steel shipments exceeding 100 million tonnes, representing around 10% of world steel output.

## Protect the Gap

Steel surfaces are coated with a thin layer of molten zinc to create what we know as galvanized steel. The exposed zinc reacts with oxygen to form zinc oxide, which in turn, reacts with carbon dioxide to form zinc carbonate, a fairly strong material that helps stop further

corrosion. A problem arises, though, when steel is cut into the desired lengths during manufacturing. At the cut edge, the steel substrate and zinc coating are both exposed.

Zinc is electrochemically more reactive than steel. When the two are in contact with each other and a moisture layer, then the zinc will act as the more reactive metal and sacrifice electrons to dissolve as zinc ions in the moisture layer (reacting with hydroxide ions to form the corrosion product). This is known as galvanic protection, and ensures that the steel will not corrode, as it acts as the noble metal in the electrochemical circuit. Yet, when enough of the zinc has disappeared, the

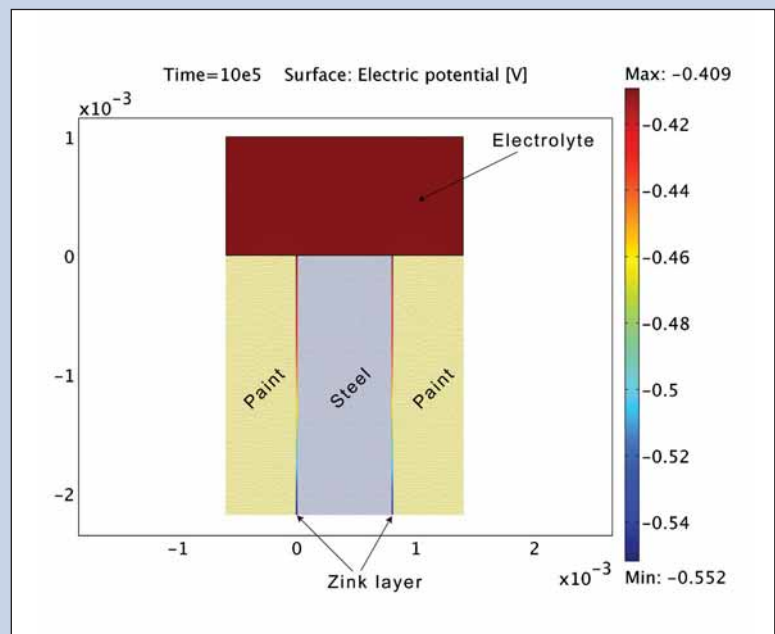
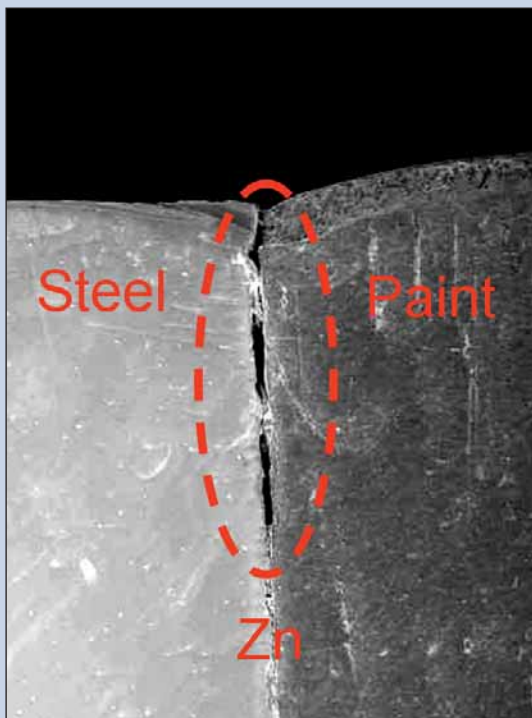

Figure 1: Photograph (left) looking at the cross section of the cut of galvanized steel. The ring indicates where the sacrificial zinc layer has already disappeared, leading to potential delamination of the paint coating from the material. The model simulates the disappearance of the zinc layers (right).

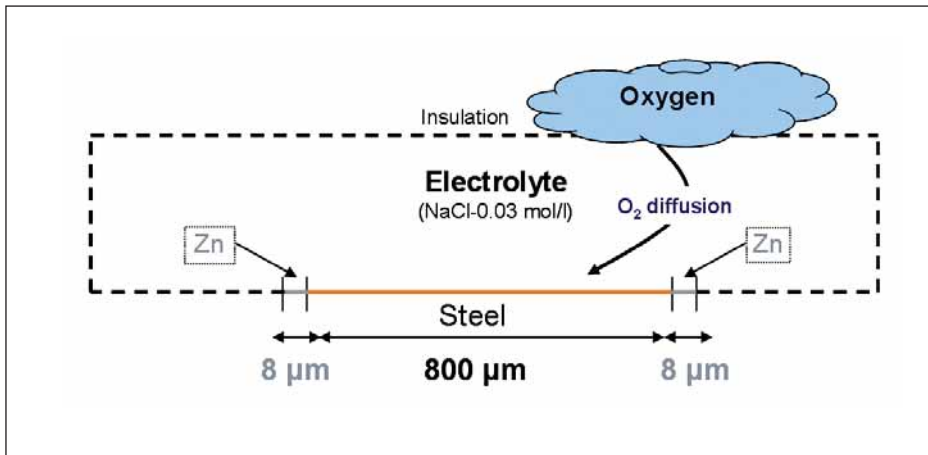

Figure 2: The physics of the corrosion model. Oxygen dissolves in water, such as a rain drop, and this in turn ionizes to hydroxide ions. The zinc metal loses electrons and dissolves as zinc ions. The electrons are then available in the steel to electrochemically react with hydrogen ions and complete the electric circuit.

rate of its corrosion becomes hindered, and the steel then starts to corrode instead. This is especially the case when the disappearance of the zinc layer leads to difficulties for the participating ions to transport themselves through the moisture layer, such as in the gaps between the paint and steel, created by the corroding zinc. The steel starts to react with the atmosphere and the paint starts to delaminate; see Figure 2.

Researchers have found that a key variable that determines how quickly the gap develops and the paint delaminates is not the absolute amount of zinc but rather the relative thickness of the zinc to that of the steel (ratio of Fe/Zn). If the zinc layer is too thick, it not only consumes unnecessary amounts of expensive zinc, it can lead to problems during welding, and that material also generates hazard-

ous pollutants. In contrast, a layer that is too thin provides effectively no galvanic protection.

The question is thus: what is the maximum ratio of Fe/Zn that guarantees protection of the substrate? Until now, the primary method of finding the best thickness was with accelerated corrosion tests in the laboratory, but that is not sufficient because tests are not only time consuming but are not always truly representative of a material's performance in actual environments. Instead, our engineers want an explanation of what they observe so they can better address the issue. This has become possible only with modeling, which not only adds understanding but saves time and money because it is no longer necessary to perform a large number of laboratory tests to evaluate product performance.

### Modeling Goals

As stated earlier, one of our goals was to understand the mechanism behind delamination and underpaint corrosion, and Figure 2 shows a diagram of the physics we model. In addition, there has always been considerable discussion as to whether the dominant process is cathodic or anodic corrosion. With the COMSOL® model we have a much better understanding of the underlying phenomenon and have determined that anodic corrosion arises more in products with good adhesion such as those we deal with, whereas cathodic corrosion is more important in systems with less adhesion.

In the anodic mechanism, coating thickness plays a critical role in the delamination rate. Thus, we also wanted to study the most effective and least costly thickness of the zinc layer. Our dynamic

“We found that with COMSOL® you don't have to be a modeling expert to get very useful results.”

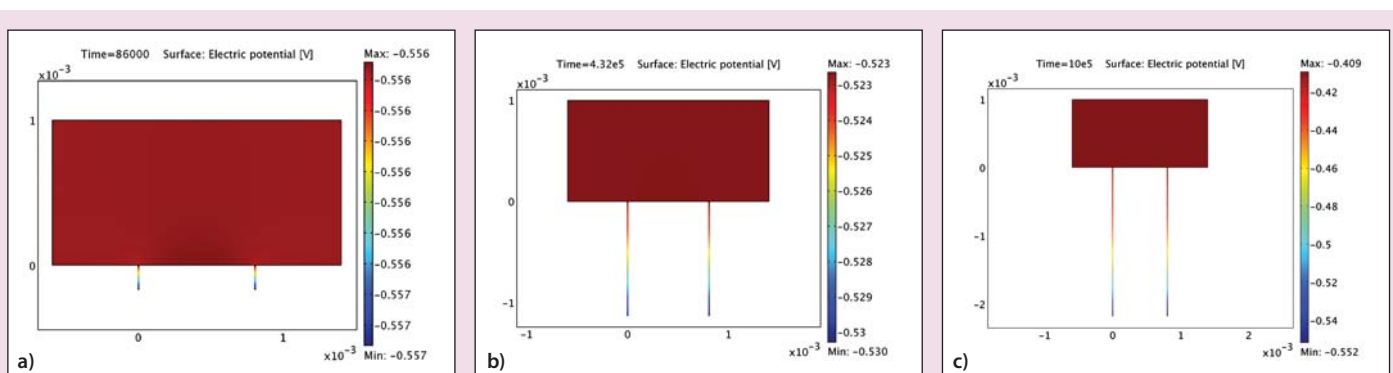

Figure 3: COMSOL model of electrochemical potential and zinc consumption after 1 day (a), 5 days (b) and 11 days (c) of exposure to salt spray.



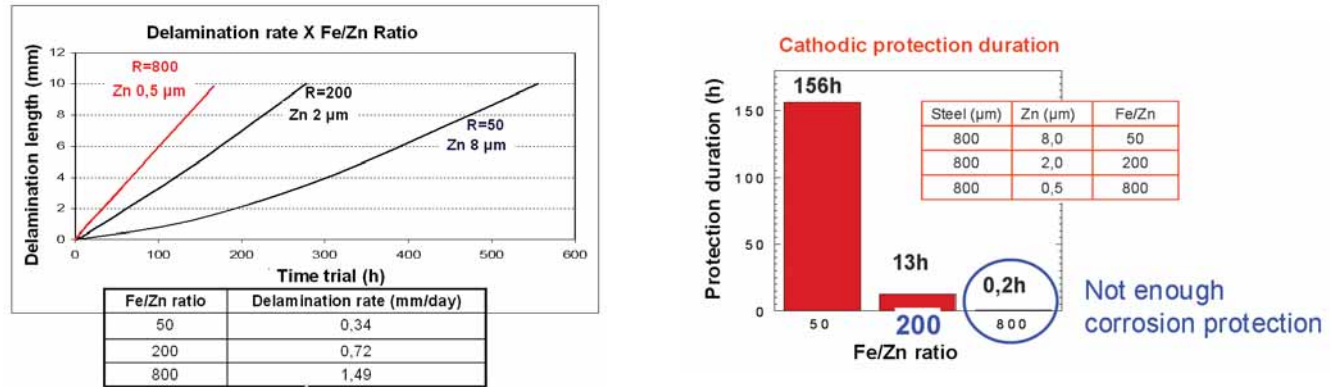

Figure 4: COMSOL results help determine how thin we can make the zinc layer without losing cathodic protection.

model allows us to follow the delamination front as a function of corrosion time (Figure 2b).

We are starting to get some very good information. We know, for instance, that for a given thickness of steel, the delamination rate increases with a decrease in the coating thickness. The model also allows us to analyze the evolution of the electrolyte potential at the steel surface as a function of zinc corrosion. In this way it becomes possible to determine the duration of cathodic protection by calculating the time necessary for the steel surface's potential to achieve Fe equilibrium potential — which is the time after which steel dissolution can start to occur. And while the results

are based on some simplifications, the trends are relevant. The results confirm that a ratio of Fe/Zn = 800 does not confer an acceptable corrosion protection to steel; the protection well is lost after only a few minutes.

Such knowledge has already helped us in practical applications. Before we had the model, our production engineers wanted to save money and deposit only a few hundred nanometers of zinc. However, our model showed that doing so makes no sense because this amount provides almost no anodic protection. In the same way, our model allows us to give recommendations for optimizing the zinc thickness according to the final use of the coated product.

### Future Projects

This was our first entry into mathematical modeling, and we spent quite some time evaluating various software. We read a number of interesting scientific articles that mentioned COMSOL and investigated it. We found that with COMSOL you don't have to be a modeling expert to get very useful results.

The current model works with stationary corrosion conditions, but an automobile faces continually changing conditions that vary in the amount of humidity and salt content. We plan to expand the model to handle these situations. We also want a tool that will allow us to model the electrochemical behavior of new coatings that consist of other zinc compounds that allow for a thinner layer. In these first efforts we are focusing only on the coatings and not on different grades of steel, even though this is also an important aspect to consider because auto parts do not all use the same types of steel. We plan to start looking at high-strength and specialty steels in this context. In addition, we would like to simulate corrosion products' precipitation, cyclic corrosion conditions and simulate alloyed coatings — aspects we intend to address in the coming years. ■

READ THE RESEARCH PAPER AT:  
[www.comsol.com/papers/2757/](http://www.comsol.com/papers/2757/)

## About the Authors

Christian Allély (left) holds a Ph.D in Electrochemistry from the University of Paris. In 1990 he joined ArcelorMittal R&D where he is currently a corrosion expert in the Automotive Product Research Center and responsible for the management of European projects on corrosion of coated steels. Tiago Machado Amorim is a Ph.D Student in Christian's team modeling corrosion protection.



# Simulation Addresses Band-Broadening in HPLC Systems

COMSOL Multiphysics helps Waters Corp. cut costs and save time in their HPLC business.

BY CATHLEEN LAMBERTSON

In the simplest terms, High Performance Liquid Chromatography (HPLC) is a separation technology — a process used to separate different chemical species that are in a mixture. And while HPLC is one of many separation technologies available, it is the most prevalent because of its versatility. These systems are most commonly used in the pharmaceutical and biotech industries, in functions as diverse as R&D, manufacturing, and quality control. They are also increasingly finding applications in food, water, and environmental monitoring. For instance, during the tragedy that occurred in China in 2008 in which baby formula was found to be contaminated with melamine, analysis of the contaminated formula was done with Waters HPLC systems.

Founded in 1958 and headquartered in Milford, MA, Waters Corp. designs and manufactures complementary analytical technologies such as liquid chromatography, mass spectrometry, rheometry, and microcalorimetry, which account for approximately \$5 billion of the estimated \$20-\$25 billion worldwide analytical instrumentation market. Bernard Bunner, a principal engineer at Waters, said, “HPLC is the original business of Waters and still represents the largest part of the company’s activity and revenues. Waters’ systems account for about 20% of the worldwide HPLC market.”



An Acquity UltraPerformance Liquid Chromatography (UPLC) instrument.

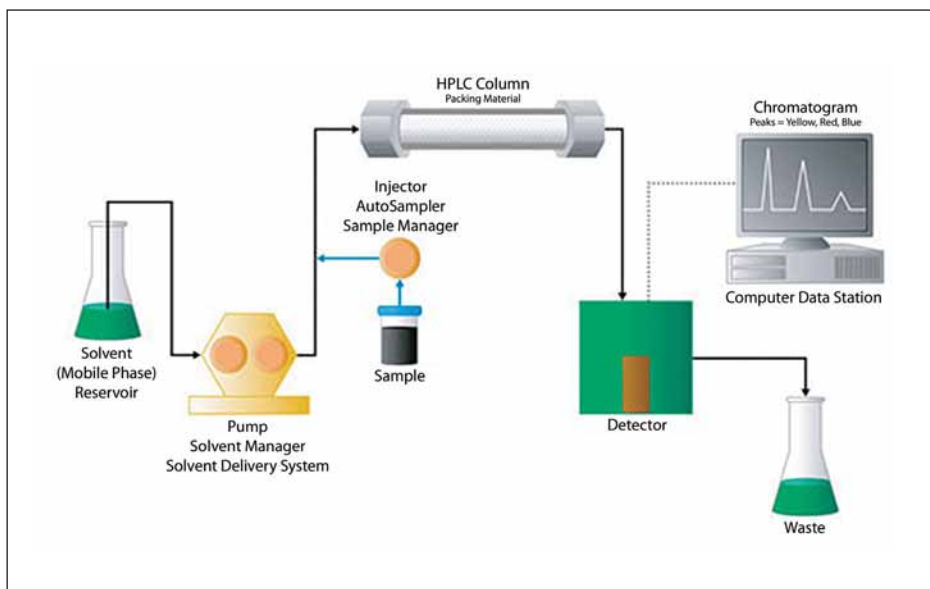

Schematic of an HPLC or UPLC system operating in isocratic mode. A high-pressure pump delivers a constant stream of mobile phase, typically acetonitrile in water, to the HPLC column. A plug of the sample to be analyzed is injected into this stream. At the outlet of the column, the separated components of the sample are detected and appear as peaks on the chromatogram.

## The HPLC System

According to Bunner, an HPLC system includes what can be considered a really big desktop computer (instrument), as well as a chromatographic column — a stainless steel tube at the core of the instrument. The column typically measures ~6 mm OD and 2.1 mm ID. This column is packed with particles that measure a few microns in diameter. The solution containing the chemicals to be analyzed flows through the column. At the inlet, there is a mixture of chemical species and at the outlet, there are separated chemical species typically identified with an ultraviolet (UV) absorbance detector.

The chemical analysis of the sample results in a chromatogram — a plot of UV absorbance versus time showing the different chemical species as distinct peaks. While ideally the peaks should be as sharp as possible, diffusion is unavoidable. Therefore, HPLC instrument

designers seek to lessen extra dispersion (band broadening) associated with factors such as large dead volumes, poorly packed columns, thermal mismatches, and the like. In order to minimize this problem of band broadening, Waters enlisted the help of COMSOL Multiphysics software.

## Why COMSOL?

Currently, Bunner uses COMSOL for his work in the Instrument Research Group, which focuses on the development of new instruments and new products based on new technologies. Several people in Waters’ Chemistry Operations — responsible for the development of the columns — use simulation too. “COMSOL is the only simulation software at Waters that has the capability of simulating complex fluid and thermal problems,” said Bunner.

Waters is using COMSOL to study band transport in a chromatographic column, both in the case of a standard 2.1-mm



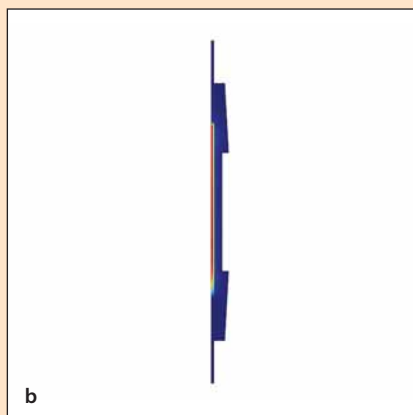
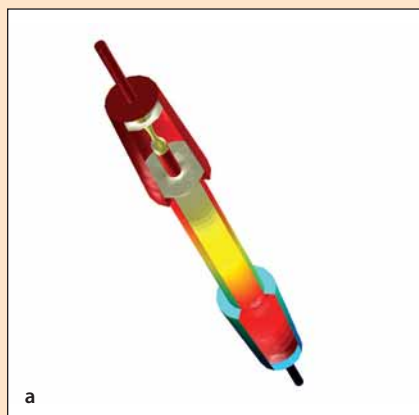

Temperature map in the 2.1-micron column, calculated using axisymmetric geometries, for two different boundary conditions: a) Adiabatic BC: the column is fully insulated and heat loss only occurs through fluid that flows out of the column. The maximum temperature rise is 16.6°C; and b) Isothermal BC: The column is immersed in a liquid bath maintained at constant temperature. Heat is mainly carried away from the packed bed through radial conduction through the column. The maximum temperature rise is 1.7°C.

solved. The equation of mass transport is used in the open fluid parts of the model, with the diffusion coefficient being the molecular diffusion coefficient of the analyte as it travels through the columns. “In a porous medium, however, diffusion is more complex and due to a number of factors having to do with the nature of the packed bed we had to resort to an ad hoc model where the diffusion coefficient was calculated using an equation,” Bunner stated. “One of the nicest features of COMSOL is how easy it is to use to define your own models and tailor it to one specific problem. We are still using the standard application mode of COMSOL and we use the mass transport equation. We are just writing equations for some terms in that equation,” he added.

### Small Particles, High Heating

In beds packed with particles smaller than 2  $\mu\text{m}$  (1.7- $\mu\text{m}$  particles are the current state of the art) when the flow rate is relatively large, fluid flows induce shear stresses large enough to create appreciable heating through viscous friction. According to Bunner, this heating can lead to substantial differences of temperatures throughout the column, which implies that physical properties such as the viscosity of the mobile phase and the diffusion coefficient of the analytes can noticeably change. In certain circumstances, this can result in extra broadening of chromatographic peaks. “This modeling effort is especially critical because we are considering going to even smaller particles, 1.2  $\mu\text{m}$ . Smaller particles imply even higher pressures and higher heating. Getting a handle on

column and in the case of a microfluidic HPLC column. Three physical problems encountered during band transport in the 2.1-mm column were addressed using COMSOL: flow of mobile phase in

packed bed and frits is modeled using Darcy’s law.

Recently, COMSOL developed an incompressible Navier-Stokes application mode that integrates the Brinkman equa-

## “COMSOL® saved several months of development time by avoiding the need for more experiments.”

open tubes and packed beds, transport of solute, and thermal effects due to viscous friction in the packed bed. “In the 2.1-mm column packed with sub-2-micron particles, the geometry is not new; it’s the same one that’s been used in the industry for decades. Here, the physical problem becomes very complex because it adds thermal effects to what is already a complex problem,” said Bunner.

tion as an option for porous media. Bunner stated, “Brinkman’s extension combines in a single application Darcy’s Law and Navier-Stokes. It is a convenience that really simplified our lives.”

### Equation Based Modeling

In order to evaluate band broadening, an equation of mass transport has to be

### Fluid Flow in Porous Media

In an HPLC system, the column consists of a packed bed of micron-sized particles held at both ends by frits and connected at both ends to tubes. The chemical species flow through the tubes and filter through the packed bed and frits. To solve for fluid flow, both Darcy’s Law and Navier-Stokes equation are used. The equation describing the solvent motion in the tubes is the Navier-Stokes equation, while flow in the

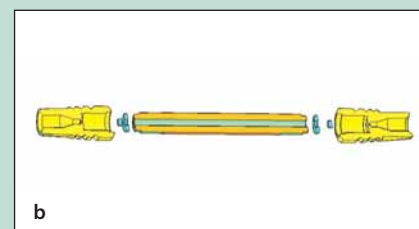
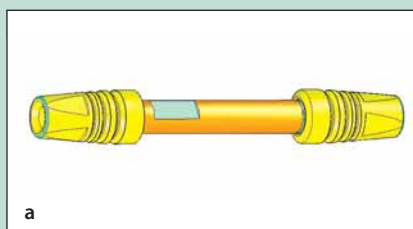

The model in assembled (a) and exploded (b) views of a 2.1-mm column. The central part contains the packing material; for example, 1.7-micron particles. The packed bed is held in place at both ends by frits and fittings for connecting tubes added at both ends.



thermal effects is even more important and COMSOL is part of this effort to see whether or not we should go forward,” said Bunner.

### Microfluidic HPLC

As for the microfluidic HPLC column, it features a two-dimensional chip device where fluid enters perpendicular to the chip then travels in a separation column (in the plane of the chip), and then travels back out of the chip. This geometric feature is different in the microfluidic chip format than in previous tubular formats based on stainless steel or fused silica capillaries. In addition, since a standard separation channel length is 10 cm, but a chip is typically less than 5 cm long, the separation channel cannot be straight, but must have bends or turns to fit into the chip. The questions that immediately arise are: What do these vias and 90-degree turns do to peak width, and how much extra band broadening do they create?

“It is difficult to evaluate the effect of each feature independently from the other since they are all part of the chip. We ran experiments with a number of different parameters (length and diameter of the via, shape of the via, bend radius of the turns), but gained most insight and understanding by using COMSOL simulations where all effects could be

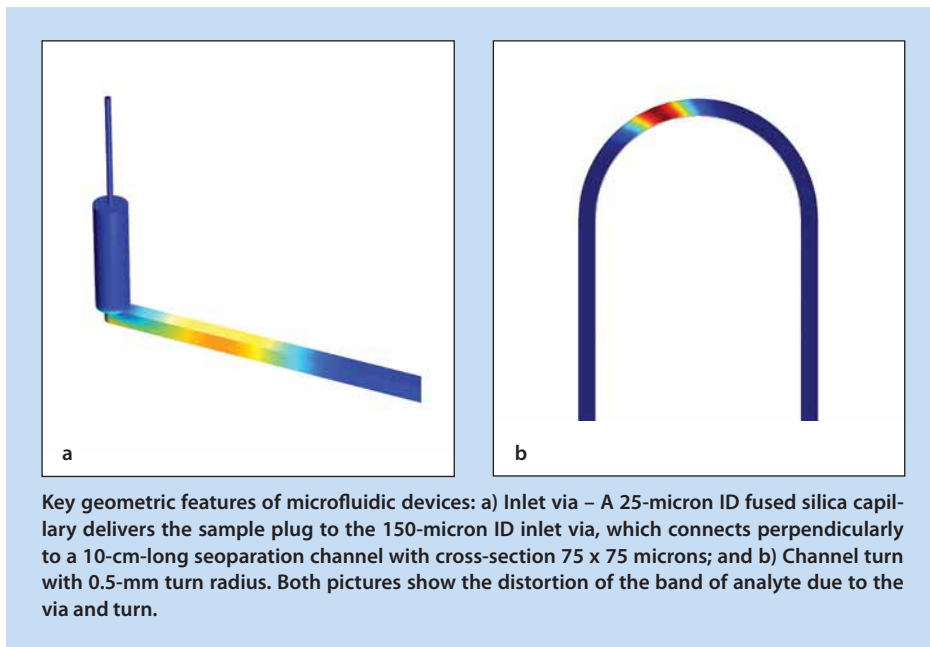

Key geometric features of microfluidic devices: a) Inlet via – A 25-micron ID fused silica capillary delivers the sample plug to the 150-micron ID inlet via, which connects perpendicularly to a 10-cm-long separation channel with cross-section 75 x 75 microns; and b) Channel turn with 0.5-mm turn radius. Both pictures show the distortion of the band of analyte due to the via and turn.

evaluated independently,” stated Bunner. “COMSOL saved several months of development time by avoiding the need for more experiments, and gave us confidence that the trends that we saw in the experiments that we conducted were correct. We gained confidence that what we are seeing experimentally makes sense and reduced the number of designs/experiments that we had to try. Also, for these very small dimensions, it is very difficult to measure and visualize what is happening. Simulation is really the only option.”

### The Benefits

Waters has been using COMSOL now for just over four years. “People who work in R&D have seen a lot of benefits from doing simulations — from understanding fundamentally what happens to guide design, prototyping, and development. It’s really about fewer prototypes; fewer design variations, which translates to shorter development time; and reduced R&D and manufacturing costs,” Bunner said. “It also results in better-informed decisions. Instead of just doing one test and then having 20 people in the meeting and using very crude, preliminary and rudimentary data, you are able to study many different aspects of the problem,” he said. “[In addition] you can do thought experiments, like ‘what if we vary the material we are using? How would a different material affect the thermal problem? What if you used aluminum instead of stainless steel?’ Now, if you are trying to evaluate the problem using experiments, you first have to find a vendor who makes this in aluminum. This doesn’t exist. So you’re talking about setting up a one-year program to evaluate this one experiment. If you do this in a simulation, you’re done in less than a day.” ■

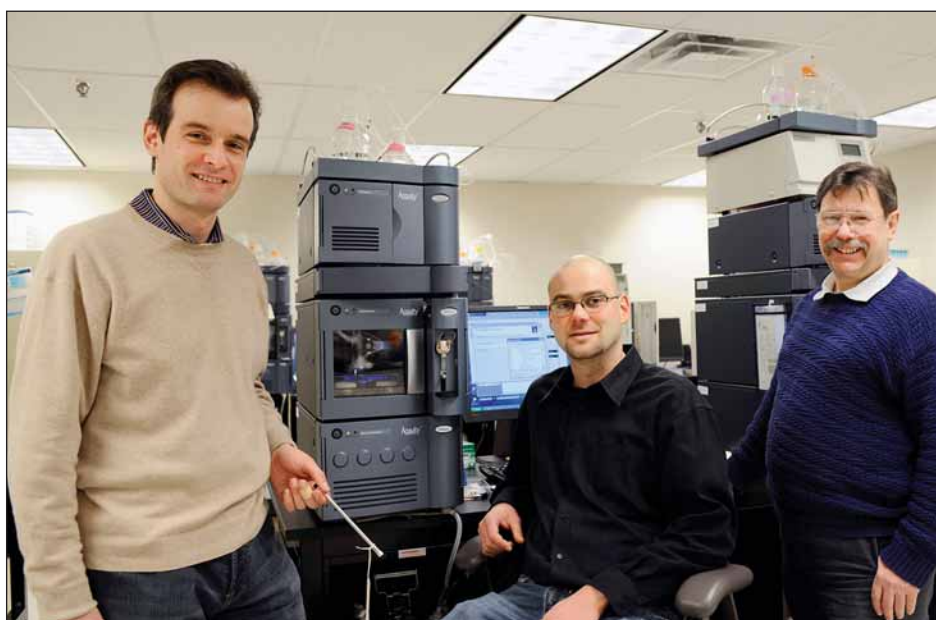

Waters HPLC simulation team (left to right) Bernard Bunner, Markus Wanninger, and Uwe Neue.

READ THE RESEARCH PAPER AT:  
[www.comsol.com/papers/5145/](http://www.comsol.com/papers/5145/)



## COMSOL® Reveals How to Avoid Very Expensive Modifications to Wastewater Clarifier

A wastewater treatment plant encountered a problem with one of its redesigned clarifier tanks. A group of consulting engineers used COMSOL Multiphysics® and the Mixture Model application mode to determine that there was no need to make physical modifications that could have cost in the range of 1,000,000 in Euros; instead, adding a certain chemical to improve flock (floculent) formation cost only 100,000 Euros — and thus modeling saved the company 90% of the costs.

BY ARIE C. DE NIET, WITTEVEEN+BOS, DEVENTER, THE NETHERLANDS

In municipal wastewater treatment, clarifiers are a central component. In these large circular tanks (Figure 1), activated sludge that consists of biological microcultures removes nitrogen and phosphorous from the waste; at the end of the treatment process, the activated sludge must be separated before the clear water flows into the environment. The heavier sludge flocs settle to the bottom of the tank where it flows through a return conduit and is removed for reuse (bottom left of Figure 2); the clear water floats over the top at the tank's outer boundaries (upper right of Figure 2). A

number of deflector plates promote proper circulation so the sludge has an opportunity to settle to the bottom of the tank and work its way out the return conduit.

### Problems Surfaced After Reconstruction

A local wastewater authority in the Netherlands was experiencing trouble with one of its clarifiers after having reconstructed it to divide it into an inner part and an outer part. After reconstruction only the outer part was used for sedimentation. They found that too much sludge

was leaving with what should have been clear water at the top, and at the bottom the exiting sludge contained too much water. The water authority struggled for 18 months to find a way to get the outer part working properly. Then, to help them find out what the problem was and how to correct it, they turned to the consulting firm Witteveen+Bos ([www.witteveenbos.com](http://www.witteveenbos.com)). This company, which employs roughly 800 engineers and had sales in 2007 of more than 91 million Euros, offers its clients advice and designs in the areas of water, infrastructure, the environment, spatial development and construction.

The first step was to model the flow in the clarifier. While many of our mechanical engineers use specialized modeling software, I was looking for a package that could handle the multiple linked physics of this problem. I had encountered COMSOL on the web and read in Dutch magazines targeted at environmental engineers how other water authorities had already used COMSOL for such studies. In a trial, I found that COMSOL was very easy to use, especially for coupling the various physics, the geometry modeling was quite good, and I also found the many example models quite useful.

In particular, the Mixture Model application mode in the Chemical Engineering Module proved invaluable. It can compute the flow for a mixture of two liquids or a liquid and a solid. The predefined physics



Figure 1: The modeled clarifier tank in the wastewater treatment facility. Photo courtesy of Witteveen+Bos.





“In particular, the Mixture Model application mode in the Chemical Engineering Module proved invaluable.”

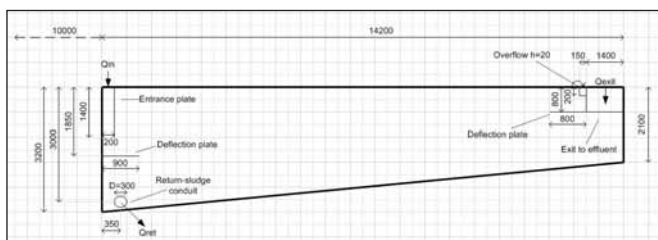

Figure 2: A cross section of a clarifier from the center (left) to the outer ring (right). The wastewater enters at the upper left and exits from the upper right; the sludge collects on the bottom surface and is then pumped from the return-sludge conduit on the lower left.

setting implements a multiphysics connection between the  $\kappa$ - $\epsilon$  turbulence model for the main flow with equations for the transport of the dispersed phase and the relative velocities of both phases.

When we ran our model of the existing clarifier tank, we noticed that after it reaches equilibrium, the streamlines show a short-circuit flow (Figure 3, top). In other words, part of the incoming flow goes straight to the return sludge conduit at the lower left, and there is no time for the sludge particles to settle. We surmised that the short-circuit flow was caused by the tank's shape. But even though it would likely be very effective to modify the shape or change the position of the return sludge

conduit, doing so would be an extremely expensive proposition, costing more than a million euros. Thus, we searched for less expensive ways to change the flow pattern.

### Modeling Finds the Cost-Effective Solution

Naturally our thoughts turned to the deflection plates. With the COMSOL model it was easy to study the effects of changing their horizontal and vertical positions as well as their length and slopes. We discovered, though, that there was no significant reduction in the amount of sludge at the water outflow.

Fortunately, we found that two other measures appeared to be effective in the

model: an increase of the sludge density or an increase of the flock diameter. With the model, we determined that the most effective choice was the latter. Best of all, there are available means to change the properties of the sludge; flock formation can be altered by adding certain chemicals to the mixture before it enters the clarifier. Better packing of sludge particles in this way results in higher densities, and stimulation of flock growths leads to an increase in the flock diameter. Figure 3 (bottom) shows model results for some new values of sludge density and flock size that we achieved with the proper chemical mix, and note that the flow is more stable and the short-circuit flow has disappeared. The particles have time to settle on the bottom and there is better transport of the sludge particles to the return conduit at the bottom left.

Our client has since implemented the chemistry changes we recommended and found that these measures did solve the problem and the clarifier functions far better than before. And rather than spend perhaps more than a million euros to restore the tank's shape to the previous geometry, they spent only 10% of that for the necessary chemicals to stimulate flock growth and also to replace the pumps in the sludge return conduits. ■

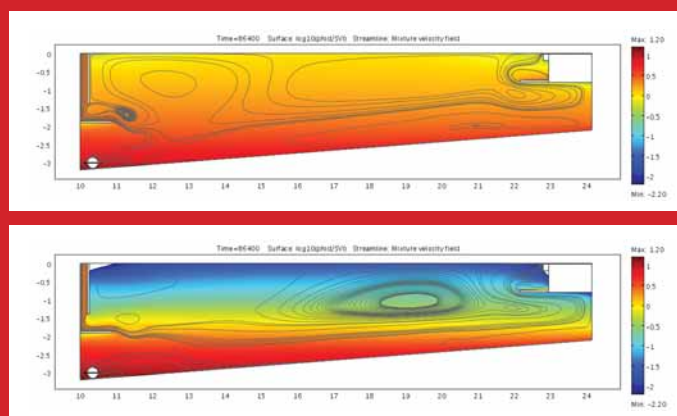

Figure 3: In the original configuration (top), some wastewater can follow a short-circuit route from the input (upper left) to the sludge exit (lower left) without the particles having an opportunity to settle. An additive changed the flock diameter, which eliminated the short-circuit flow and allows the sludge particles to settle (bottom).

## About the Author

Arie de Niet is an advisor on statistics and applied mathematics at Witteveen+Bos consulting engineers in Deventer, the Netherlands, and has been working with COMSOL Multiphysics for almost two years. He studied applied mathematics at the University of Groningen, and his previous employment was at the university developing improved algorithms to solve ocean models. (website: [www.witteveenbos.nl](http://www.witteveenbos.nl), email: [A.dNiet@witteveenbos.nl](mailto:A.dNiet@witteveenbos.nl), phone: +31 570 69 7307)



READ THE RESEARCH PAPER AT:  
[www.comsol.com/papers/5310/](http://www.comsol.com/papers/5310/)



# Reduced Stresses Inside Semiconductor Chips Lead to Higher Reliability

BY LUCA CECCHETTO, LUCIA ZULLINO AND LORENZO CERATI, STMICROELECTRONICS, MILAN, ITALY

**S**emiconductor manufacturers, thanks to technological advances that are leading to a continuous scaling of lithographic dimensions, are creating integrated circuits (ICs) that are increasingly smaller. Reducing silicon consumption without decreasing device reliability can mean multiple millions of dollars in cost savings. Thus, Pad Over Active (POA) structures have been implemented in most advanced semiconductor technologies in order to optimize area consumption. With it, active circuitry is designed below test/bonding pads to exploit the interconnection properties of multilayer metal stacks. Simulation with COMSOL Multiphysics® allows STMicroelectronics to study these effects and formulate design rules that lead to robust circuits.

## Multilevel Interconnections

In an IC, it's necessary to carry signals from one subcircuit to another, and for this purpose a chip uses multiple layers of metal interconnects, each separated by an interlevel dielectric (ILD) layer. Small conductive plugs called vias, often made of tungsten, pass signals from the silicon to a metal layer and also from lower metal layers to the upper one (Figure 1). Further, an IC needs conductive pads on the surface that connect to internal circuitry for two reasons: first, to serve during final

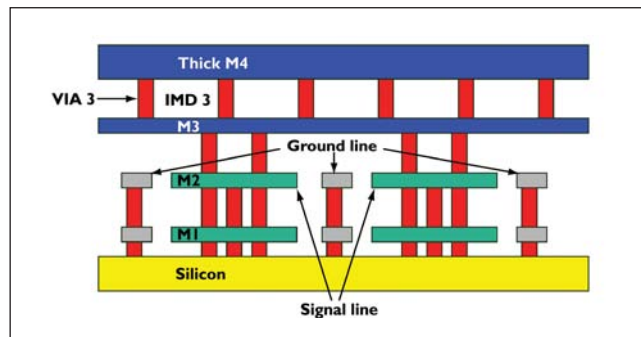

Figure 1: In an IC, circuitry on the silicon layer is connected through metal signal traces (horizontal connects), which in turn are connected to the silicon layer and other metal layers with solid tungsten plugs called vias (vertical connects).

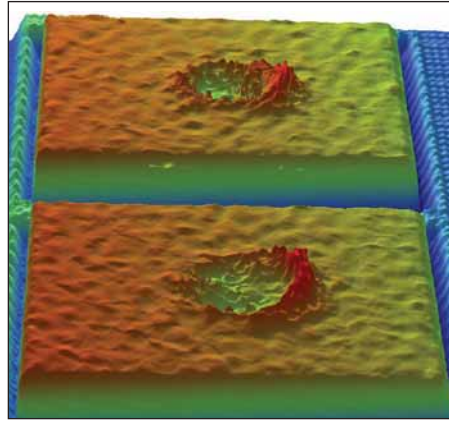

Figure 2: When a probe tip drops down onto a pad with excess force, it creates an uneven surface that can make soldering a bonding pad more difficult.

manufacturing as spots for the attachment of bondouts, which carry signals from the IC itself to the pins of the final package in which it is mounted and then shipped; second to serve as test points to verify that a device is working properly in what is known as electrical wafer sort (EWS).

EWS is conducted on each IC so as to evaluate its functionality before assembling it in a package and installing it in a final application. This testing is performed by making contact with a pad using a suitable probe by lifting the wafer (which is mounted on a chuck) until contact is established with needles that are inserted in a dedicated card; this condition is considered the

reference status (zero level). For Smart Power ICs, due to both the high current levels required and the presence of very precise analog stages, good electrical contact between the needle tip and the pad surface is mandatory. For this reason, an additional overdrive must be applied to the chuck. At the same time, the pressure of the

tip on the pad surface must be limited so it does not induce cracks in the ILD layers. Metal extrusion inside of these cracks can, in fact, lead to electrical failures. It is therefore appropriate to investigate and simulate the process so as to reduce the number of experiments, save time and money, and improve the probe's design.

## Probe Design Optimization

One of the most important targets for the EWS process is to limit the induced damage on a restricted surface. The probe tip can scrape the pad surface and create an unevenly shaped crater (Figure 2), and such a wide damaged area does not allow for a reliable bonding process.

To investigate in detail what happens when a probe tip hits a pad surface, the team at STMicroelectronics decided to use COMSOL Multiphysics in cooperation with one of its probe suppliers (Technoprobe, Italy). The team was made up of people involved in Technology CAD, POA structures development and EWS testing inside STMicroelectronics as well as people dealing with the development of probe cards at Technoprobe. The goals were to:

- 1) validate a COMSOL model with measured data
- 2) optimize the probe's design to increase the performance of the EWS process.

To get the project started, Technoprobe provided STMicroelectronics with

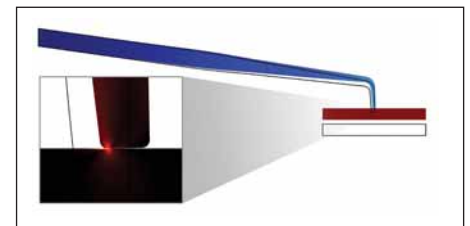

Figure 3: The top plot shows the displacements in the probe and the pad; the white shows the initial contact position and the colored plot its final position when the chuck is raised up. The zoomed area shows a plot of the von Mises stresses in the contact area that need to be investigated carefully in order to limit the induced damage.

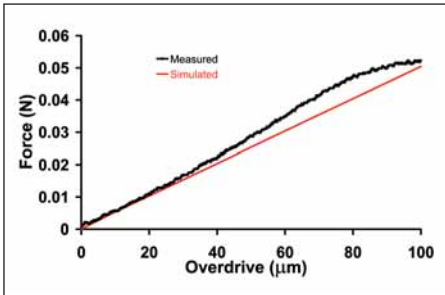

Figure 4: Simulated vertical contact forces versus the applied overdrive compared to the measured forces. The reference position is when the pad first comes in contact with the probe (zero level).

a CAD drawing of the current design of the probe as well as material data. Then, with the help of the Structural Mechanics Module, STMicroelectronics was soon able to develop a 2D mechanical contact model (Figure 3). The results were then compared to measured data (Figure 4).

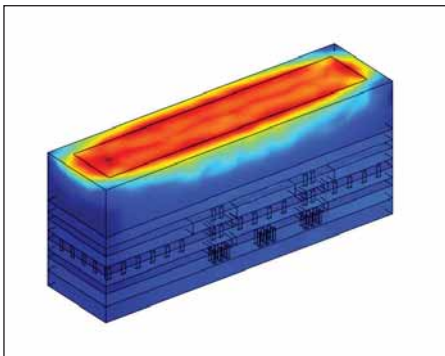

Figure 5: 3D geometry of an IC subsection used as the basis of a COMSOL model to measure stress in the ILD layers. Shown are the von Mises stresses.

“It was only with the COMSOL® model that we could determine the areas of peak stress and understand how failures could arise.”

Because comparisons with the results from the model were satisfactory, the team decided to continue to model in 2D and optimize the probe’s design.

The optimization of the probe’s geometry resulted not only in a new and thinner body but also a longer tip. The modified design resulted in better contact between the tip and the pad, less contact force and a shorter probe mark length. The model and later experiments confirmed that the

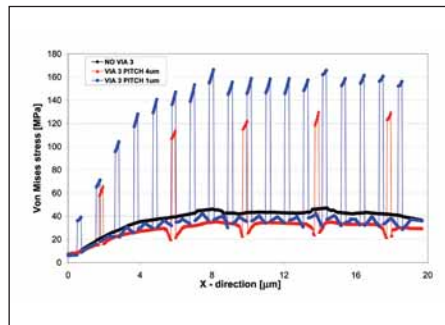

Figure 6: Von Mises stress in a semiconductor chip inter layer dielectric as a function of via pitch.



Figure 7: Authors Luca Cecchetto (left) and Lucia Zullino examine a model of the IC probe.

new configuration provides the equivalent electrical performance with 30% less force.

### Modeling the ILDs

To improve the pad’s mechanical robustness, a 3D model (Figure 5) of the pad structure and the ILD layout was simulated. Figure 6 plots the von Mises stress in the top ILD for several via pitches. The black line shows the stress without vias, and there are no stress peaks. The other curves show that as spacing gets smaller, stresses rise; the difference between the 1  $\mu\text{m}$  and 4  $\mu\text{m}$  pitch is roughly 30%. With this model, we can study the number of vias that we can safely put under a POA while still remaining within a safe level of ILD stress. And it was only with the COMSOL model that we could determine the areas of peak stress and understand how failures could arise. ■

READ THE RESEARCH PAPER AT:  
[www.comsol.com/papers/2508/](http://www.comsol.com/papers/2508/)

## The STMicroelectronics COMSOL User Group

The popularity of the COMSOL Conferences conducted around the world each year attests to the benefit of being able to sit down with other COMSOL users to exchange tips and experiences. With this in mind, Lucia Zullino and Luca Cecchetto have formed an informal User Group inside STMicroelectronics with roughly 15 COMSOL users who meet at least once every quarter.

“The User Group meetings have been a valuable tool for me to discuss COMSOL products with my colleagues,” explains Sarah Burgarella, who has been a user since 2006. “Even though we are all working on different topics, we can still learn a great deal from each other. The User Group makes us all more efficient with the software.” She works at ST’s e-health group at the Agrate facility, which is working with COMSOL to simulate dielectrophoresis (DEP), a method for the manipulation and separation of biological cells under the action of high-gradient electric fields, which in turn can be used for lab-on-chip devices.

“These meetings are beneficial to us because we would like to use the software to examine a wide variety of things and especially for sensors,” adds Dario Paci of the Technology R&D department. “Although I had already used COMSOL during my studies at the University of Pisa, I still attend the User Group meetings to get even more knowledge about the package.”

The User Group is particularly useful for those who are somewhat new to the package, an example being a team of seven people from the MEMS group, located in Cornaredo. They are working with COMSOL on the design of accelerometers and gyroscopes, among other products. Their main use of COMSOL Multiphysics deals with coupled problems involving structural mechanics and electrostatics, but microfluidics and acoustics will also be studied. Notes Francesco Procopio, “Because we are new to COMSOL Multiphysics, the User Group meetings should be valuable for us to get input from our colleagues in Agrate, who have been using COMSOL for several years.”



# Sun-Powered Flight

UNLV researchers use multiphysics to optimize a solar-powered unmanned aerial vehicle.

LOUIS P. DUBE, WADE A. MCELROY, AND DARRELL W. PEPPER

**S**olar power is an increasingly attractive way to sustain aircraft aloft for extended time periods without refueling. Advances in photovoltaic and battery technologies have progressed to a point where it is possible to charge and store sufficient power in the sunlight to run the vehicle off a battery all night. But solar-powered flight is, by default, underpowered. A delicate optimization of properties — weight, surface materials, and geometry, for example — is required to minimize flight power requirements so that an aircraft can fly for days at a time.

My teammates and I used COMSOL Multiphysics® extensively to model, analyze, and optimize a solar-powered unmanned aerial vehicle (UAV) under development at the University of Nevada Las Vegas. The refinement of wingtip devices in particular was recognized as an area where we could improve the UAV's aerodynamics.

## Winglets for All Flight Conditions

The UAV we designed is propelled by an electric motor that spins a nose-mounted propeller. The wingspan is approximately 10 feet, and thin-film solar panels are arrayed across the top of the wings. Power is stored in rechargeable lithium-ion batteries, which are housed within the main fuselage along with avionics.

Winglets are an economical way of modifying an aircraft to lessen induced drag and reduce power requirements at a given airspeed. Winglet design, however, gets complicated because the aim is to reduce

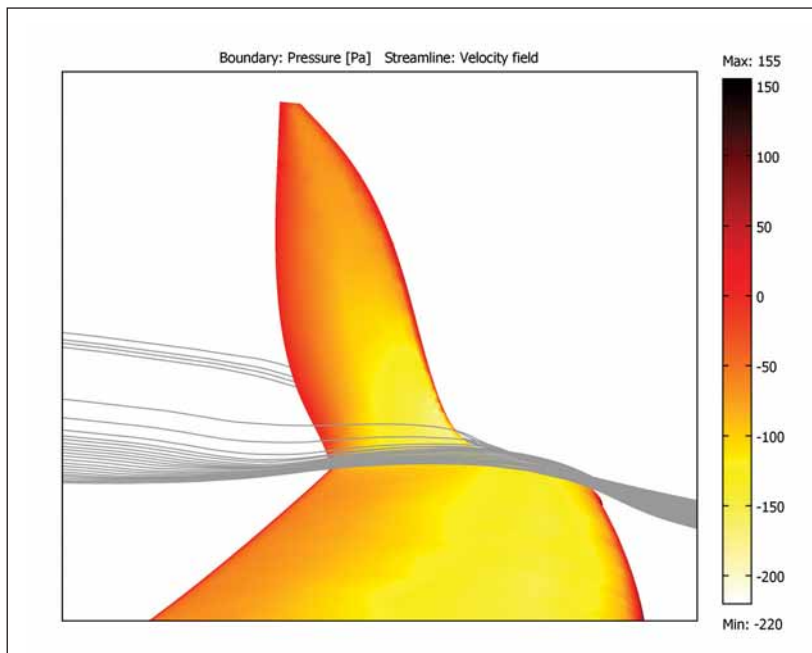

Figure 1: COMSOL Multiphysics simulation showing boundary pressure distribution and streamline detail on the inside face of non-planar winglet in loiter at +2° angle of attack. Notice the progressive dissipation of the useful pressure gradient, starting nearly one third of the way up the winglet. The reason for this drop off in performance is likely due to the formation of a laminar separation bubble, propagating down the span of the device.

overall drag in all flight conditions — as opposed to designing for a single operating point — while simultaneously ensuring that the design does not induce penalties under the complete flight regime. The design is also a highly proprietary problem without a general solution, so each design requires unique consideration. Planar winglets usually try to either capture the strength of the trailing vortices or delay their creation further outboard. Non-planar versions usually aim to do the same but tend to be more efficient since they are out of the wing's plane. Our focus here is on non-planar devices.

Winglets can increase wing bending moment, especially if they increase a wingspan or if they are non-planar lifting surfaces. They act like a cantilever beam that's loaded. So, such questions as “Am I adding stresses to the wing? How is this going to behave in a dynamic setting? Will it flutter?” arise. For these answers, we

performed a structural study to ensure the appropriateness of our fabrication techniques and material selections.

## Fluid-Structure Interaction Simulation

As with most fluid flow problems, a virtual wind tunnel was ideal. COMSOL enabled us to test different geometries and materials without machining every single design for a wind tunnel test. What we did was export our SolidWorks® models into COMSOL where we then created a fluid box surrounding the model. We left room around the object to analyze flow, yet kept the box tight enough to lower the number of internal nodes to a minimum.

Typically, the fluid box had one inlet and one outlet, three slip surfaces, and one symmetry boundary at the root of the geometry being analyzed. The geometry consisted of non-slip interior

**“The aim is to reduce overall drag in all flight conditions.”**

boundaries. The box also provided easy boundary specifications for the structural problems. Additionally, this method let us estimate drag forces produced by various components easily.

We used COMSOL to assess different geometries numerically, which, for the winglets alone, meant seven distinct



configurations. We used various solvers for the fluid-flow problems but, generally speaking, the turbulent flow segregated solvers gave the best results when paired with geometric multigrid preconditioning.

The structural analysis proved demanding because of its multiple physics and our desire to solve our fluid and structure problems simultaneously. COMSOL's fluid-structure interaction (FSI) modeling interface handled these problems properly and efficiently with its default segregated solver settings and minor modifications to the geometric multigrid solver. The FSI application mode couples Navier-Stokes equations with a solid stress-strain analysis type and uses a moving mesh (ALE method) for shape deformation. The FSI model was later modified to use the turbulent flow solvers.

### Validating Simulation Results

COMSOL's output capabilities allowed us to analyze the results from simulations easily and quickly to gather a lot of information simply by inspection. The winglet design study showed an overall drag reduction of 8.1% at cruise conditions over the original wing design, with smaller reductions in other flight conditions, such as banking flight or shallow climbs. Superimposing gathered data from COMSOL onto the UAV's flight polars showed no performance penalties and good correlation.

COMSOL's boundary integration capabilities was especially powerful when coupled with weak constraint variables. This allowed us to find changes in overall drag quickly. The weak constraint variables offered an easy way to compute drag and lift coefficients. We used this feature numerous times during the fluid-flow analysis, both as a way to benchmark the accuracy

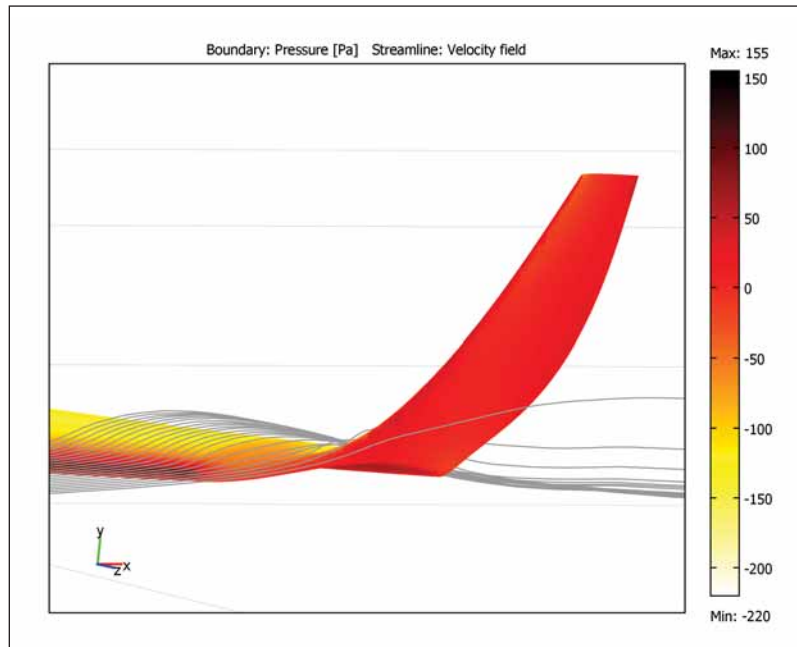

Figure 2: This pressure distribution and streamline detail shows a +4° angle of attack. The flow in the area near the winglet root still displays outstanding adherence. Notice how the fluid spills from underneath the bottom of the leading edge into the bottom surface of the winglet.

of the models against known values and the obtained results against predicted data using various panel methods.

FSI allowed us to observe the effect of winglets on the airframe dynamically from an aerodynamics and structural point of view. The results were numerically compared to the original cases, and direct considerations regarding the manufacturing of the airframe were completed on the fly. For example, with polystyrene, a building material we evaluated, the original wing showed a deflection of 0.0004 inch at the tip as

compared to a 0.007 inch tip deflection with a winglet device.

### All-Inclusive Design

COMSOL Multiphysics proved a valuable tool in the development of the UNLV solar-powered UAV. We demonstrated that COMSOL can be used for small-scale evaluation of flying platforms, such as UAVs, and that it provides an all-inclusive way to approach a design problem and arrive at a development solution quickly.

COMSOL provided results in a timely manner, allowed us to optimize key parts of the airframe, and to observe the structural side effects

of modifications. The ability to simulate various flight conditions using single or multiple physics enabled an iterative design process and facilitated the development of the design into a numerically ready airframe. ■

*This article was excerpted from the Proceedings of the COMSOL Conference 2008 Boston. The full technical paper entitled "Use of COMSOL in Aerodynamic Optimization of the UNLV Solar-Powered Unmanned Aerial Vehicle" is available as a PDF download at [www.comsol.com/papers/5424/](http://www.comsol.com/papers/5424/).*

## About the Authors

At the time of this research, Louis P. Dube was a graduate student at the University of Nevada Las Vegas. He is now a practicing engineer. Wade A. McElroy is currently an engineering student at UNLV. Dr. Darrell W. Pepper is the Director of the Nevada Center for Advanced Computational Methods at the University of Nevada Las Vegas.

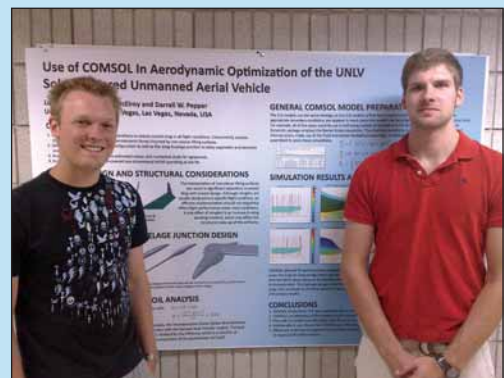

Louis Dube (right) and Wade McElroy.

# Multiphase Flow

BY DAN SMITH, COMSOL, INC.

COMSOL Multiphysics® provides users with a wide range of tools for modeling immiscible two-phase flows. These problems can be solved with a fixed mesh, where the interface between the two fluids is determined by a scalar advection equation, or with a moving mesh, where the boundary between the two fluids moves as the system evolves.

On fixed meshes, COMSOL® offers two options: the Level Set method and the Phase Field method. The level set method represents the interface between the two fluids by a certain contour of a smooth function. The COMSOL implementation of the level set method is unique in that the thickness of the interface always remains the same. It also has significantly better mass conservation properties compared to the original level set method.

The phase field method is a relatively new technique and is based on the Cahn-Hilliard equation. In this case the free energy of the system is minimized within some timescale. Since the Cahn-Hilliard equation is fourth order in space, it is decomposed into two second order partial differential equations. Surface tension is conveniently implemented as a body force in the Navier-Stokes equations. Although the level set method provides better

mass conservation, the phase field method has proven to be more robust than the level set method in most cases. Both methods offer superior implementations of the surface tension force over the volume of fluid (VOF) method which must reconstruct the interface from a discontinuous function at each timestep. The mean curvature in particular can make it difficult to accurately account for surface tension using the VOF method.

## Level Set Method

In the original level set method, a signed distance function is used. The main drawback of the originally proposed level set method is that mass is not conserved, and significant mass loss may occur. In COMSOL Multiphysics, we use a modified version of the level set method, which has significantly better conservation properties. It is in essence a compromise between the original level set method and the VOF method, with high-order accuracy, and with good mass conservation.

The level set application mode is used to create the plot in Figure 2, which shows the fluid interface inside a T-junction. T-junctions are commonly used to create emulsions where small liquid droplets are suspended in another liquid.

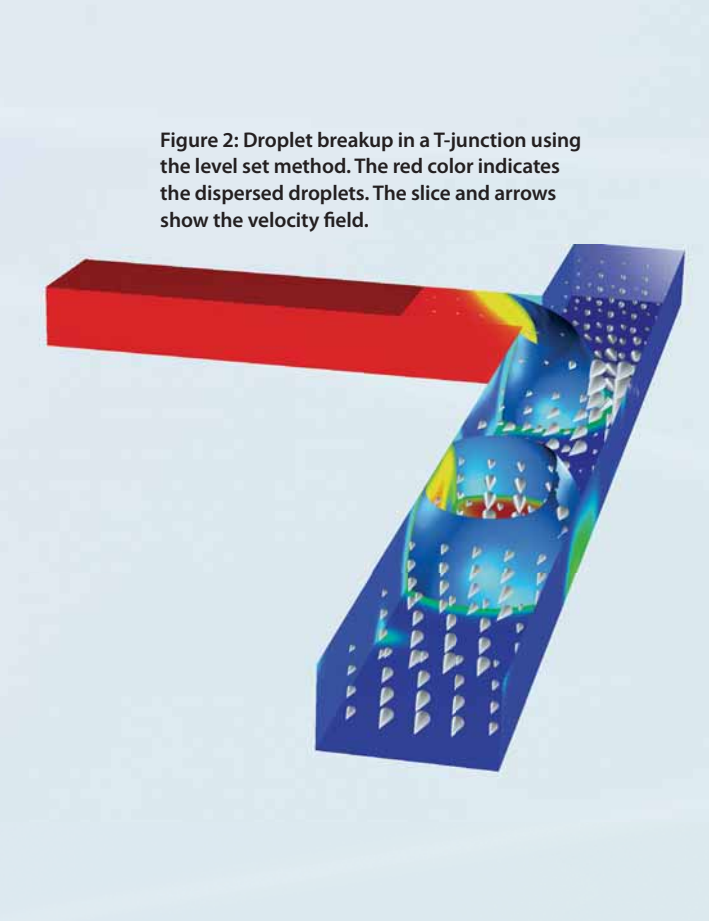
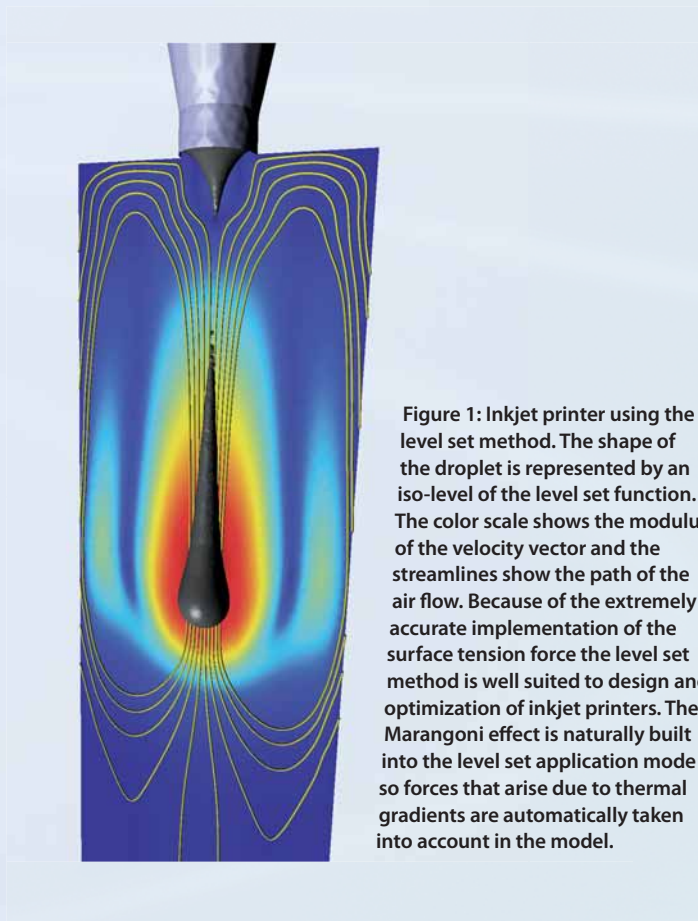
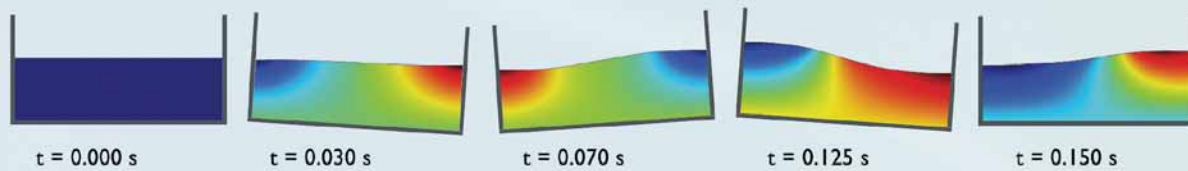

Figure 4: Sloshing tank using the ALE method. Plot of the velocity field in a tank perturbed with a sinusoidal motion.



### Phase Field Method

The phase field method offers an attractive alternative to more established methods for solving multiphase flow problems. Instead of directly tracking the interface between two fluids, the interfacial layer is governed by a phase field variable,  $\phi$ . The surface tension force is added to the Navier-Stokes equations as a body force by multiplying the chemical potential of the system by the gradient of the phase field variable. The phase field method can even be solved on a moving frame of reference by coupling it to the moving mesh application mode. This allows fluid structure interaction problems involving two fluid phases to be solved. Figure 3 shows the deformation and stresses inside a rubber obstacle when it is perturbed by a breaking dam. The model simulates four effects: the phase field method to track the interface, the flow field, the stresses and strains in the solid obstacle, and the moving mesh required to describe the dynamics of the system.

The phase field model has another advantage in that it can be coupled to the  $\kappa$ - $\epsilon$  or  $\kappa$ - $\omega$  turbulence models. This means that COMSOL Multiphysics can now be used to solve turbulent multiphase flow problems such as impingement of high speed liquid jets. The phase field model can easily be coupled

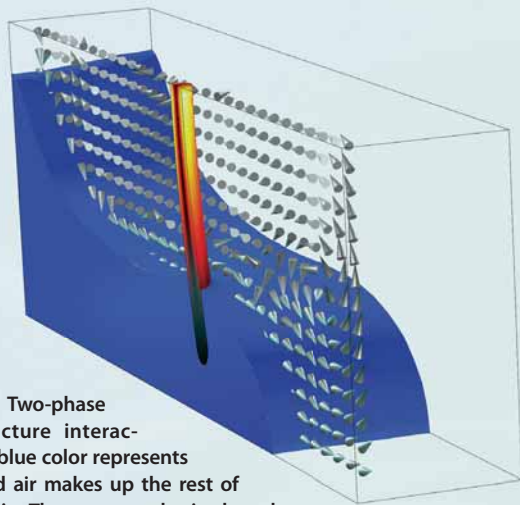

Figure 3: Two-phase fluid-structure interaction. The blue color represents water and air makes up the rest of the domain. The orange color in the rubber obstacle highlights regions where the von Mises stress is high. The red arrows show the direction and magnitude of the velocity field.

to other physics modes. For example, when coupled to electrostatics, elongation of liquid droplets due to electric stresses can be modeled. This is known as electrocoalescence. If the phase field model is coupled to heat transfer then complex phenomena like film boiling can be modeled.

### Arbitrary Lagrangian Eulerian (ALE) Method

When high accuracy and perfect mass conservation are required, the ALE method can be superior to both the level set and phase field approaches. Surface tension is conveniently implemented as a boundary condition on the free surface rather than as a volumetric body force. Another advantage of the ALE method comes from the exact boundary that separates the two fluids. This boundary enables auxiliary physics to be modeled in either the gas or liquid phase individually. For example, a mixing tank where chemical reactions are occurring only in the liquid phase could not be handled by the level set or phase field methods, but it can be done with ALE.

### State-of-the-Art Solver Technology

COMSOL Multiphysics provides a wide range of solver tools for multiphase flow problems. The problems can be solved in either a coupled or segregated manner. The coupled approach solves for the pressure, velocity, and phase field or level set functions simultaneously using state-of-the-art multigrid solvers. The amount of memory and CPU-time required to solve large scale multiphase flow problems can be substantially reduced by using a transient, segregated solver. In this approach, the velocity and pressure are solved in one group and the phase field or level set functions are solved in a separate group. The solver iterates between the groups at each timestep until convergence occurs. In certain applications, this can result in time and memory saving of a factor of two.

### Summary

In summary, COMSOL Multiphysics provides a wide range of tools for modeling systems involving two immiscible fluid phases. Applications include micro-channel separation, electrocoalescence, inkjet modeling, injection molding, fuel system modeling, film boiling, and microfluidics. There are three approaches available to the user. The first two, more well-established methods, are known as the level set and ALE methods. The third and newest, now available in COMSOL 3.5a, is called the phase-field method, which has proven to be accurate, robust, and easy to couple to other types of physics. ■



The inaugural live demo session of “20 Tips & Tricks” at the COMSOL Conference in Boston triggered a great deal of positive feedback. We’re thrilled to share some of the session’s highlights here. Download the Tips & Tricks Model Files at [www.comsol.com/support/knowledgebase/1042](http://www.comsol.com/support/knowledgebase/1042).



Niklas Rom  
COMSOL support

## Global Constraint

It is easy to add a global constraint to a model through the Global Equations interface. Let’s look at an example: You have a heat conduction problem and you want only to allow a maximum temperature at some part of the body, perhaps due to materials limits. This maximum temperature is not included

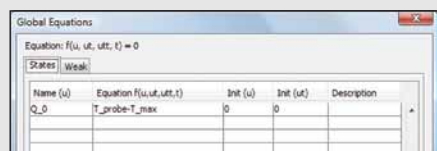

Global equations are useful for many interesting model applications, of which the above is maybe the simplest.

in the boundary conditions or materials settings of a PDE model. It needs to be added as an additional equation. That single equation needs to be fulfilled at the system level, which is why we call it a global equation. Since we add an extra equation, the constraint, to the system, we need to add an extra unknown. In this case we use the distributed heat source  $Q_{\text{heat}}$  in the heat conduction PDE and make it a global dependent variable instead. This type of problem is sometimes referred to as a backward problem. Here are the necessary steps:

- 1) Probe the temperature at the point of interest and make it globally available through the menu Physics > Coupling Variables. Call it  $T_{\text{probe}}$ .
- 2) Create a global equation where you define  $Q_{\text{heat}}$  as the dependent variable and specify the simple equation  $T_{\text{probe}} = T_{\text{max}}$ . Note that the dependent variable need not be included in the equation itself. ■

## Space Integration

Your COMSOL Multiphysics model will typically give answers in field variables, such as the spatial distribution of temperature or velocity field. However, many times you are interested in system scalars like total heat duty (in kW) or mole flow (in moles/s). If you have a flow conduit, the mole flow  $F_m$  of a chemical species out across the exit boundary is

$$F_m = \int (\bar{N} \cdot \bar{n}) ds$$

where  $\bar{N}$  is the molar flux and  $\bar{n}$  is the normal vector to the outlet boundary. To set this up: Use the boundary integration tool from the menu Options->Integration Coupling Variables->Boundary variables. The integrand is often available as a pre-defined application variable for you to use. For example, in a

convection and diffusion application mode, the normal flux,  $\bar{N} \cdot \bar{n}$  is available as the name `ntflux_c_cd`. ■

## Time Integration

This is an extension to the first tip in that it involves setting up a global equation, but this time we make a global ordinary differential equation (ODE). Let’s stick to the flow problem and, in a similar way as above, set up the mass flow at the exit as  $F_{\text{mass}}$  (kg/s). In a time-dependent problem, you may be interested in how much mass  $M$  has exited at a certain time  $t_i$ :

$$M = \int_0^{t_i} F_{\text{mass}} dt$$

This type of time integration can be performed by setting up the differentiated version of the above equation as a global ODE

$$\frac{dM}{dt} = F_{\text{mass}}$$

This is done in the Global Equations dialog the same as in the first tip.

## Stop Condition

When you have performed the previous step to track the total mass that has exited in every time instant, you can tell the the solver to stop when you reach a certain value. Use the Stop condition in the Time Stepping page of the Solver Parameters dialog box. The expression in the edit field should be a logical expression. ■

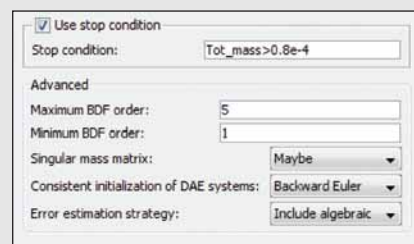

## Sweep 2D Axisymmetric Solution to 3D

If you wish to visualize an axisymmetric 2D solution in 3D, extrusion coupling variables will do the trick. The image below shows the principle. ■

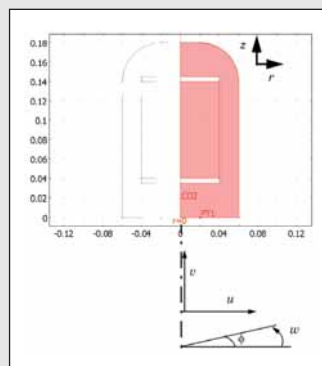

The left figure depicts the axisymmetric model domain. The right plot shows the solution revolved to 3D.

# COMSOL CONFERENCE WORLDWIDE



Milan · Boston

## Join the Leaders in Multiphysics Simulation

COMSOL Conference 2009

Boston, Oct 8-10 / Milan, Oct 14-16

### Hands-on Minicourses

Get hands-on training in more than a dozen topics

### Keynote Talks and User Presentations

Tap into users' applications and research

### Exhibition & Poster Session

Showcase of simulation products and services

### Demo Stations

Test drive new products and meet with support and application engineers

### Tutorial Presentations

Demonstration of specific modeling and simulation techniques in COMSOL Multiphysics®

### Awards Banquet

Meet and interact with your colleagues.  
Prizes for best papers and posters

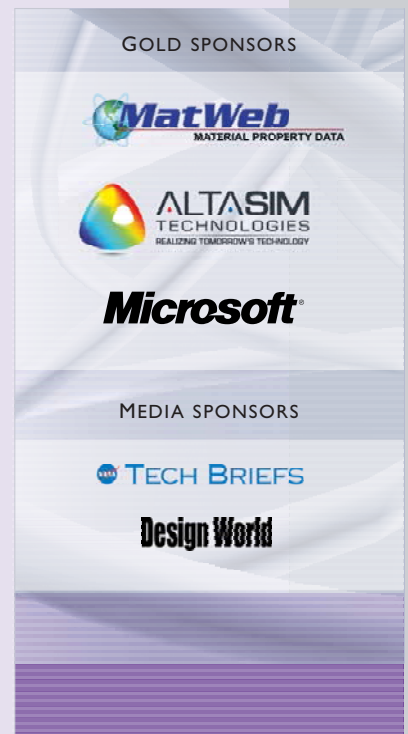

[www.comsol.com/conference2009](http://www.comsol.com/conference2009)



© 2009 COMSOL Inc. COMSOL, COMSOL Multiphysics, and COMSOL Reaction Engineering Lab are registered trademarks of COMSOL AB. Other product or brand names are trademarks or registered trademarks of their respective holders.



# Leveraging 3D Direct Modeling Tools for CAE and Model Preparation

The emergence of 3D Direct Modeling tools is enabling manufacturers to modernize their design-through-manufacture process, fully leverage their investment in skilled engineering staff, and address bottlenecks.

Direct modeling unlocks the creation of concept models, creating a productivity breakthrough for CAE. With the advent of precise, easy to adopt 3D Direct Modeling tools, such as those available from SpaceClaim, engineers have the freedom and flexibility to capture ideas quickly, edit solid models regardless of origin, and prepare designs for analysis, prototyping and manufacturing.

Engineers are more productive with 3D tools designed with engineering needs in mind. Until recently, few appropriate tools existed that were suitable for most engineering challenges. Engineers have long needed tools that can create models without the overhead of a CAD system; work with a wide variety of 2D and 3D source data; and are easy to learn, use, and deploy. Recent advances in computer hardware have enabled a new generation of 3D tools that finally bring solid modeling to engineers and other casual users. These “direct” or “explicit” modelers present a hands-on, meaningful approach to solid modeling that thrives in the conceptual and “what-if” phases of a product’s lifecycle.

The concept of direct modeling is refreshingly straightforward: engineers are able to create and edit a model onscreen by directly pushing and pulling on the geometry, which provides hints to the modeler for how the change should interact with the surrounding aspects of the design. Direct modelers typically have no fixed concept of design intent, enabling concepts to evolve organically and opportunistically. How a model was created, or even its originating CAD system, does not change how the model can be edited. Models can be created and manipulated in any view, any document, or any cross section, fixing problems wherever they are found.

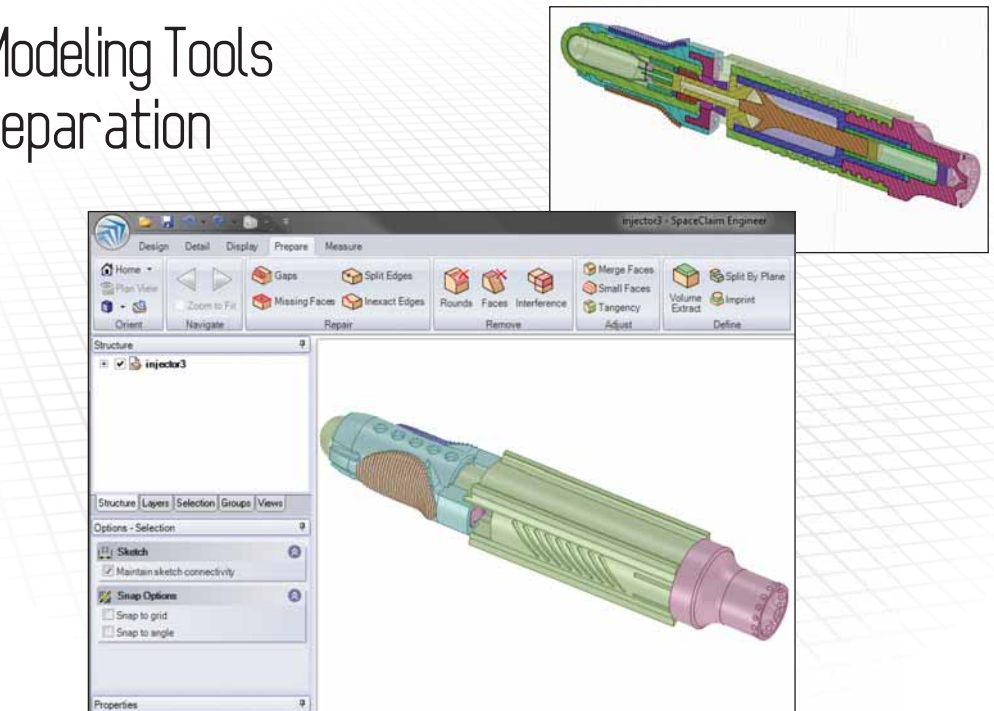

SpaceClaim makes it easy to prepare and simplify models for analysis in COMSOL. Using SpaceClaim, you can create new design concepts and contextualize existing designs in their physical context, as well as de-feature imported designs for meshing.

Concurrency, enabled through 3D direct modelers, fosters innovation and expedites development cycles. Companies become more competitive when they optimize their product development process for product innovation, development cost, and time-to-market. The best way to enable innovative thinking, reduce costs, and expedite the development cycle is to maximize concurrency. When activities occur simultaneously rather than sequentially and teams have access to each others’ data, the design process can be shortened dramatically. However, if the teams working in parallel don’t actively communicate, their output can diverge, causing additional rework and hampering improvement.

SpaceClaim’s 3D direct modeler expands the use of 3D throughout the product lifecycle, and enables simulation and analysis to drive the design process rather than extending it. Engineering teams build consensus by easily sharing concept models with SpaceClaim 3D tools that are CAD-neutral, powerful, accessible, and cost effective. Through interoperability with leading simula-

tion and analysis solutions, including COMSOL® Multiphysics®, SpaceClaim enables engineers to conduct analysis and optimize results prior to moving to detailed design.

SpaceClaim’s products are on their fourth release and were developed from the ground up to specifically give engineers and industrial designers the freedom and flexibility to capture ideas easily, edit solid models regardless of origin and simplify designs for analysis, prototyping and manufacturing. Unique capabilities in SpaceClaim include intuitive Pull, Move, Fill and Combine tools for robust model editing, as well as straightforward 2D and cross-section modeling.

Emerging 3D direct modeling tools are finally uniting the extended design team and shrinking development cycles via concurrent engineering. In today’s market climate, manufacturers are well-served by evaluating their overall design process and investing in technologies that move innovative products to market more quickly and at lower cost than ever before. With direct modeling, engineering concept models have become a reality. ■





# 3D DIRECT MODELING AT ITS BEST

# SPACECLAIM ENGINEER

*SpaceClaim® Engineer is the world's fastest and most innovative 3D direct modeler. It enables engineers to easily create concepts and prepare 3D designs for digital prototyping, analysis, and manufacturing.*



## FREE 30-DAY TRIAL DOWNLOAD TODAY!

[www.spaceclaim.com/trialcom](http://www.spaceclaim.com/trialcom)

#### SPACECLAIM SUPPORTS COMMON FORMATS:

ACIS, STEP, IGES, ECAD, Rhinoceros, CGR, DWG, DXF, STL, OBJ, XAML, VRML, and 3D PDF (requires Adobe Acrobat 9 Pro Extended). Optional SpaceClaim Engineer modules include data exchange packages for Pro/ENGINEER, Inventor, CATIA, VDA, Parasolid, SolidWorks, and NX.



Toll Free: 800-636-6004 +1-978-482-2148 [sales@spaceclaim.com](mailto:sales@spaceclaim.com) [www.spaceclaim.com](http://www.spaceclaim.com)

© Copyright 2009 SpaceClaim Corporation. SpaceClaim is a registered trademark of SpaceClaim Corporation. All other names mentioned herein are either trademarks or registered trademarks of their respective owners.



Intro

Cov

ToC



## GUEST EDITORIAL

## Physics Modeling in Generation X and Beyond

COMSOL Multiphysics® is enabling a new generation of scientists and engineers to pursue discovery and innovation through numerical modeling. The shift began when I was in graduate school in the 1990s. Before this time, graduate students typically wrote custom C-scripts to solve general partial differential equations. This was especially the case in multiphysics work, where the large commercial tools for mechanical or electromagnetic field modeling were tailored towards narrow classes of problems. The investment in developing these models was enormous at times,

steals opportunities to focus on fundamental science and engineering. Saving the time on basic components that are well-established allows even those with the most enviable skills to more quickly contribute something new.

Users knowledgeable in numerical methods find a powerful and customizable toolbox in COMSOL®. Less savvy users find a suite of detailed and helpful manuals, default solvers that work on broad classes of problems, and a responsive help desk. I feel relieved — I can focus on the physics and offer new ideas to my

research community. I am no longer left in envy of my brilliant peers who can code up an integrator over breakfast, though I continue to learn from them as COMSOL is populated by a like-minded crowd.

While on one hand I want the time-savings of using well-established tools, on the other hand I want to know what's “under

the hood” in terms of the physics and basic numerical methods. In my research, however, I prefer to leverage the latest numerical methods to make new contributions in multiphysics design. This is where COMSOL's framework is unmatched. While many long-established numerical packages are outstanding within a narrow physical domain, there is often a lack of transparency and certainly flexibility in the physics being solved and the meth-

ods being employed. COMSOL, in a single interface, offers a broad range of physics, making it easy for users to solve a variety of new problems. In addition, users with a solid understanding of the physics enjoy an ability to access detailed equations from an easily navigated interface.

“COMSOL, in a single interface, offers a broad range of physics, making it easy for users to solve a variety of new problems.”

The availability of a general and capable PDE solver not only empowers an individual, but compels one to consider using the tool for the sake of technical progress as a community. If a given contributor is able to offer her models in a standard, publicly available format, then others in the broader community can more easily build on these results to advance research in the community as a whole. In the case of numerical modeling, many forward thinking academic groups do make their custom codes available to others. However, these tools are not always user-friendly and easily adapted to new problems. I find myself of the strong opinion that, if a problem can be solved using a commercial multiphysics tool, then it should be. When the required capability is available, the use of a mature tool will rapidly facilitate large-scale progress in physics and engineering research. ■



**Amy Duwel** is currently the **MEMS** (Micro-Electro-Mechanical Systems) Group Leader at **Draper Laboratory**. Her technical interests focus on micro-scale energy transport, and on the dynamics of MEMS resonators in application as inertial sensors, radio-frequency components, and chemical detectors. Amy leveraged COMSOL to support her research on energy loss mechanisms (thermoelastic damping in particular) in high frequency MEMS resonators. She received a BA in physics from the Johns Hopkins University in 1993. Her MS (1995) and PhD (1999) are in Electrical Engineering and Computer Science from the Massachusetts Institute of Technology.

but absolutely necessary for progress in physics and engineering research. The level of elegance and functionality of these custom numerical tools depended heavily on a student's prior training and skill in this area. The situation parallels the time when a physics graduate student needed to build her own lock-in amplifier to do experimental work. While this skill set is unquestionably valuable, the necessity of building one's own toolset from scratch



Intro

Cov

ToC

