

COMSOL NEWS

THE MULTIPHYSICS SIMULATION MAGAZINE



**Multiphysics
Informs Business &
Engineering Solutions**

Enhancing water quality at Tauw

PAGE 6

PREVIOUS EDITIONS



Multiphysics Informs Business & Engineering Solutions

From the initial concept to the final product, finding innovative, cost-effective, and environmentally friendly designs is an intense but extremely rewarding journey for managers and engineers alike.

In this edition of COMSOL News, we tell the stories of simulation specialists working with their colleagues and customers to find solutions that can satisfy both business and engineering goals, such as eliminating production bottlenecks while ensuring the efficacy and safety of pharmaceuticals. Good designs stem from a high-fidelity representation of the laws of science governing the physics-based systems they want to simulate. With multiphysics, simulation specialists are able to include and couple all of the relevant physics effects. They create accurate digital prototypes to explore and push the limits of technology while reducing the need for physical prototypes. These specialists create simulation apps, user interfaces that simplify their multiphysics models, empowering colleagues and customers worldwide to test new ideas in the virtual world using numerical simulation.

Here, you will find concrete examples of how multiphysics simulation enables better business and engineering solutions, such as advancing computing breakthroughs, enhancing water quality, developing noncontact magnetic couplings, and minimizing corrosion in multi-material assemblies through a collaborative effort.

Enjoy your reading and happy multiphysics modeling!



Valerio Marra
Marketing Director
COMSOL, Inc.

INTERACT WITH THE COMSOL COMMUNITY

BLOG comsol.com/blogs

FORUM comsol.com/forum

LinkedIn™ linkedin.com/company/comsol-inc

Facebook® facebook.com/multiphysics

Twitter® twitter.com/COMSOL_Inc

Google+™ plus.google.com/+comsol

We welcome your comments on COMSOL News; contact us at info@comsol.com.

COMSOL NEWS

© 2018 COMSOL. COMSOL, COMSOL Multiphysics, Capture the Concept, COMSOL Desktop, COMSOL Server, and LiveLink are either registered trademarks or trademarks of COMSOL AB. All other trademarks are the property of their respective owners, and COMSOL AB and its subsidiaries and products are not affiliated with, endorsed by, sponsored by, or supported by those trademark owners. For a list of such trademark owners, see www.comsol.com/trademarks.

LinkedIn is a trademark of LinkedIn Corporation and its affiliates in the United States and/or other countries. Facebook is a registered trademark of Facebook, Inc. TWITTER, TWEET, RETWEET and the Twitter logo are trademarks of Twitter, Inc. or its affiliates. Google+ is a trademark of Google LLC.

CONTENTS

PHOTOLITHOGRAPHY SYSTEMS

- 4 | ASML Advances Computing Breakthroughs with Multiphysics Modeling

WASTEWATER TREATMENT

- 6 | Multiphase Flow Simulation Guides Wastewater Treatment Plant Design

BIOPHARMACEUTICAL PROCESSES

- 9 | Multiphysics Modeling in the Biopharma Industry

CORROSION IN MULTIMATERIAL ASSEMBLIES

- 12 | Lightweighting with Aluminum: Corrosion Apps Guide Leading Design

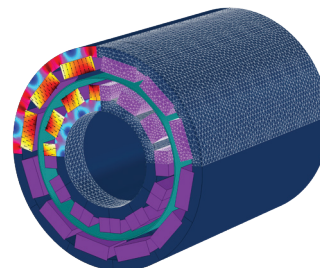

MAGNETIC COUPLINGS

- 16 | Magnetic Transmissions Increase Lifespan of Offshore Wind Farms

CORIOLIS FLOWMETERS

- 19 | Going with the Flow to Optimize Fluid Sensors



ON THE COVER

View of the meanders of the Dommel river streaming through the village of Son en Breugel, 6 miles (9.7 km) north of the city of Eindhoven, Netherlands. Image credit: Waterschap de Dommel (Dommel Water Board).

FEATURES

22 | **OPTOMECHANICS**
Optical Cooling and Thermometry at Their Absolute Finest

24 | **THERMAL ELASTOHYDRODYNAMIC LUBRICATION**
Simulation Apps Advance Tribology Research

28 | **SINTERING PROCESSES**
Improving Efficiency in Iron Ore Sintering

30 | **ACOUSTIC METASURFACES**
The Sound of Perfection Thanks to the Modeling of Acoustic Metasurfaces

33 | **AUTOMOTIVE PRODUCT DESIGN**
Optimizing Passenger Vehicle Design with Simulation Apps



36 | **LIGHTNING PROTECTION SYSTEMS**
Multiphysics Protects Wind Turbines when Lightning Strikes

40 | **GUEST EDITORIAL**
STEM Education: Simulation Apps Prepare Students for Life Beyond the Classroom

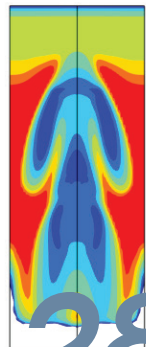
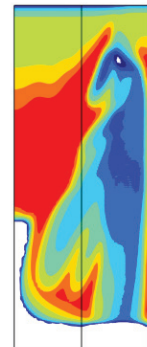
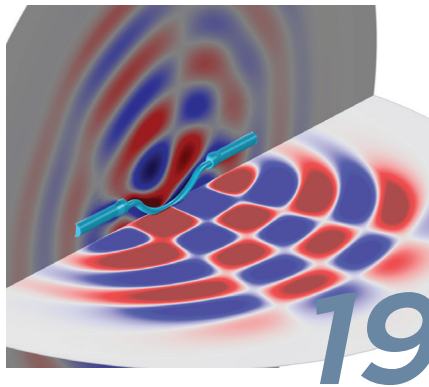
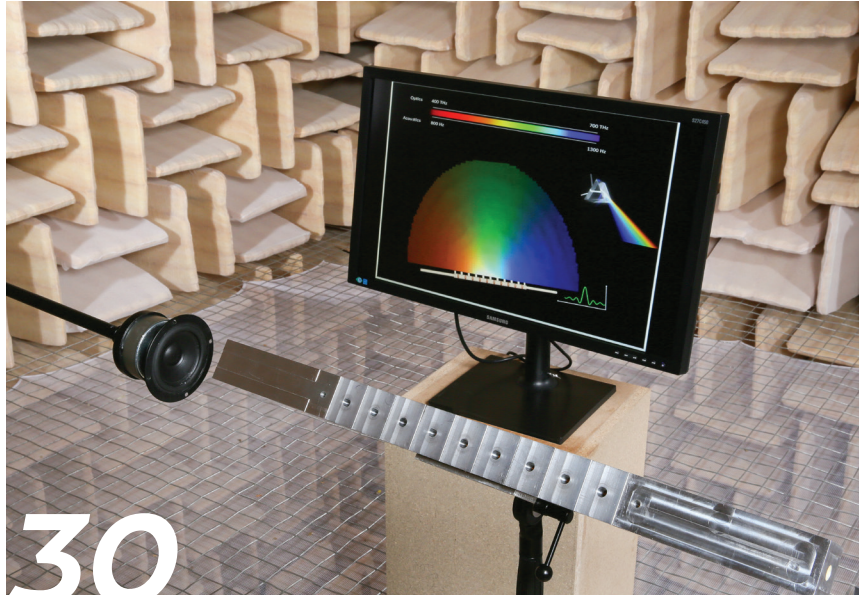

Galvanic Corrosion Behavior of a Complex Multi-Materials Assembly **NRC-CMRC** Corrosion Applications

Step 1. Components
Identify components in the corresponding tab. Select among: AA7075, AA6022, AA5083, AA6061, AA7072, AA5056, AA6111, S5304, S5201, Zn/Pb, steel, CFRP, Sn, Ti64, AlMgZn, Zn, Mg

Step 2. Electrolyte thickness
Thickness = 2.5 mm

Step 3. Electrolyte movement
Adjust the convection level
Quiescent Maximum

Step 4. Temperature
Temperature influences electrolyte conductivity & efficiency of cathode in reducing oxygen. Expected maximum service temperature is:
Temperature (C) = 20

Step 5. Compute results

Step 6. Export global galvanic current
Export global results for component in plot results using

Manual Potential Range Minimum: -0.835 Maximum: -0.546 Update Potential Distribution

Electrolyte Potential (V)

ASML Advances Computing Breakthroughs with Multiphysics Modeling

ASML reveals how multiphysics simulation is becoming crucial for the computer chip industry. The lessons they've learned are likely to be important to manufacturers everywhere.

by **VALERIO MARRA**

It seems poetic that it takes complex simulations running on powerful computers to help design the machinery that will make the next generation of computers. Such is the case with ASML, the world's leading supplier of photolithography systems. ASML makes computer chips by optically exposing microchip blueprints to a light-sensitive photoresist layer on a silicon wafer.

ASML's customers include many of the top suppliers of computer chips. To stay competitive, they must help their customers keep up with Moore's law. What they are finding is that the newest generation of machinery aimed at maintaining that progress requires understanding a level of physics where many effects, such as fluid flow and solid mechanics, are inherently coupled.

Multiphysics simulation is a nonnegotiable tool for many industries that are moving toward building devices with micrometer and nanometer levels of precision.

⇒ OPPORTUNITIES AND CHALLENGES WITH EXTREME UV LIGHT

Creating higher performance chips means cramming more transistors into a given unit area. Physical features are getting smaller (Figure 1), which poses challenges to the manufacturing process, and are sensitive to minute environmental changes. The accuracy has greatly improved from previous generations of systems. The latest photolithography machines (Figure 2) exploit extreme ultraviolet (EUV) light, which has a wavelength of 13.5 nm, to etch features. "There is a direct linear relation between the wavelength of the light that is used and the size of the components — the critical dimensions — that are projected on the microchip," explained Fred Huizinga, group leader for mechanical analysis. "We are talking about nanometer-scale features with exceptionally small tolerances."

The photolithography etching process requires a clean vacuum and the use of precision air-bearings that use a thin

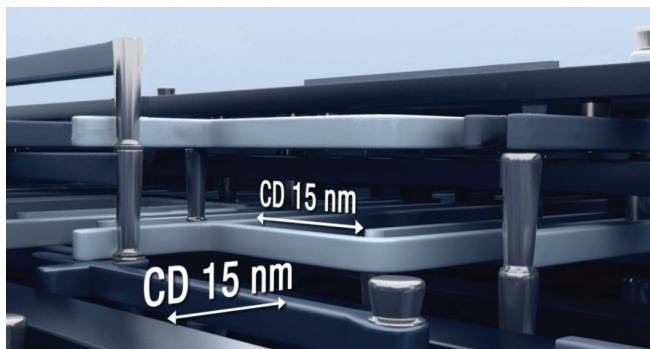

FIGURE 1. The critical dimensions inside a smartphone processor measures in nanometers. To put it in perspective, a human hair measures 5300 times larger than the critical dimensions in these chips.

layer of compressed gas between the load surfaces instead of oil or rollers. These air bearings are sensitive to micromovements and very small pressure variations have great impact on the accuracy of the etching. "In such systems, physical testing can take far too much time. In fact, some of these phenomena are so small, it is difficult to test or measure [them at all] because the deformations sometimes are of an order of magnitude that is lower than the measurement accuracy." In that case, the only engineering insight available is through numerical simulation.

⇒ A COMPLETE TOOLBOX FOR AIR-BEARING DESIGN

Huizinga joined ASML after 25 years directing engineering activities in the automotive industry. "To design and analyze our machines requires access to so many different physics, we need to use a lot of simulation tools. There are many such tools available as long as you are confined to what you might call 'single physics'; say, analyzing a problem that is entirely thermal or entirely mechanical." For him, the COMSOL® software is an especially useful tool in multiphysics modeling, since "nanometer phenomena and



FIGURE 2. The ASML® TWINSKAN® NXE:3350B production-ready EUV system produces 125 computer wafers per hour using 13.5 nm wavelength light. It must keep a perfect vacuum while moving wafers at high speeds and loads, maintaining distortions to less than 1 nm.

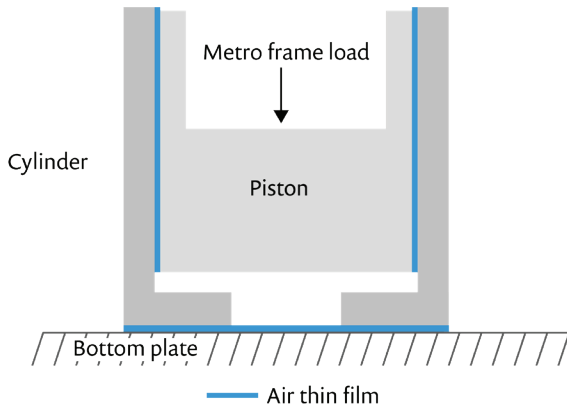

FIGURE 3. Schematic of an air bearing used in the photolithography systems at ASML.

complex systems demand a multiphysics approach, a complete simulation toolbox.”

A good example where multiphysics simulation is mandatory is their development of an air-bearing model (Figure 3). These are important to ASML because there is a lot of physical movement in photolithography machines. Air-bearings also provide higher stiffness and thermal isolation and don't release particles due to friction.

However, this precision presents new challenges. The pressure distribution of the air film will locally deform the structure and influence the width of the air gap between the bearing surfaces. Since the gap width will change the flow of air between the surfaces, it in turn affects the pressure distribution and, again, affects the deformation (Figure 4). The problem requires a fully coupled fluid-structure interaction (FSI) model, which they implemented in COMSOL. The result is a simulation that helps engineers specify important design criteria, including translational and rotational stiffness, gap size under load, and the amount of air consumed.

Another important example Huizinga pointed to for the future is simulating the load on wafers as they are placed on

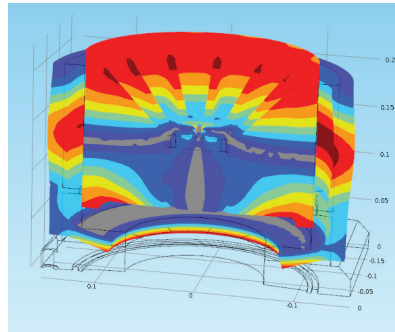

FIGURE 4. Radial deformation of the cylinder and piston in an air bearing.

the table for processing. The deformations of consequence are so small (nanometers!)

that the wafer must be modeled as an elastic body affected by gravity, friction, thermal heating, and adhesion while held in place with clamping forces using a vacuum or electrostatic field — again, a fully coupled multiphysics problem. The model will help designers to optimize their design without the need for a time-consuming and expensive prototyping process.

⇒ **COMPLEXITY MADE ACCESSIBLE WITH SIMULATION APPS**

Just as important as modeling is accessibility. Even for engineers who are competent in using multiphysics software, accessibility means providing simulation applications that take much of the routine or complex work from the user. This is where ASML finds the Application Builder tool available in COMSOL Multiphysics® handy, using it to create an Air-Bearing Calculator app that allows colleagues throughout the team to virtually test the performance of different bearing designs without digging into the original model (Figure 5). “It takes away the effort of creating a mesh, analysis setup, and postprocessing,” said Huizinga.

Developing multiphysics models, validating them as much

as possible, and making them accessible is where ASML found value in the COMSOL product suite. And like ASML, the search for quality, performance, and cost-effective operation is driving many industries into building smaller products with tight tolerances and assemblies with closely fitted parts measured in microns. While ASML and the photolithography industry are undoubtedly on the frontier of this trend, it is an inspiration to others as well. Multiphysics modeling may often be the only practical solution as engineering problems measured in nanometers emerge. ❖

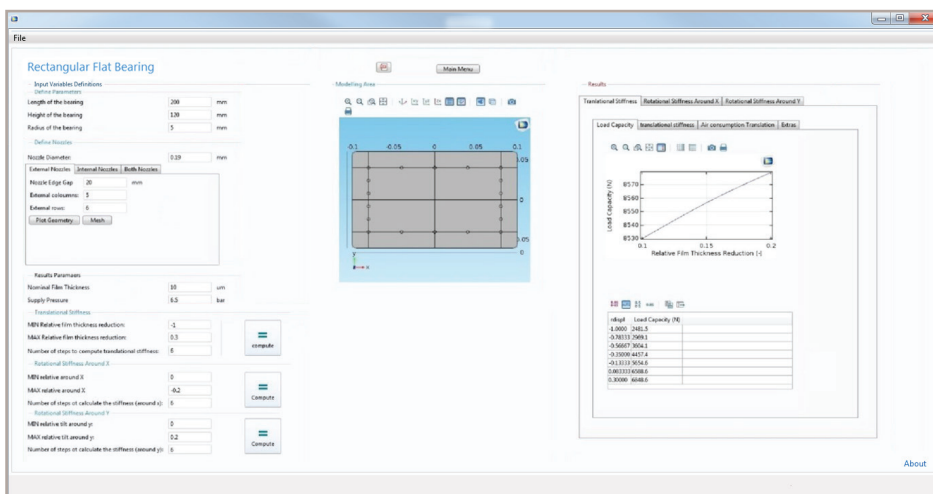

FIGURE 5. ASML created an air-bearing analysis calculator that allows engineers to input dimensions and other variables and get results, without having to specify a mesh and other model setup and postprocessing tasks.

MULTIPHASE FLOW SIMULATION GUIDES WASTEWATER TREATMENT PLANT DESIGN

Engineers at Tauw and the Dommel Water Board use computational fluid dynamics (CFD) simulation to minimize construction costs while maximizing the health of the Eindhoven Wastewater Treatment Plant.

by SARAH FIELDS

The humble Dommel river flows through the city of Eindhoven, the Netherlands, from the Belgian border in the south into the larger Maas river in the north. Along the way, it receives discharges from the Eindhoven Wastewater Treatment Plant (WWTP) as well as over 200 combined sewer overflows (CSOs) from 10 municipalities, handling approximately 170,000 cubic meters of water per day.

The Dommel Water Board is tasked with overseeing the health of the river and achieving the best possible balance between people, the environment, and the economy. To do so, the board launched KALLISTO. This comprehensive research project aims to find the most cost-effective set of measures to minimize oxygen dips and ammonia spikes caused by the combination of biologically treated WWTP effluent and CSOs. Addressing these goals allows the board to meet the Water Framework Directive and support the ecosystem of the Dommel.

“Limits for phosphate, nitrogen, and

suspended solids in the Dommel river have been and will be further reduced to maximize the health of the river,” explains Tony Flameling, senior advisor in water technology at the Dommel Water Board. As part of this effort, the Water Board introduced an aeration system to further increase the oxygen level of the biologically treated wastewater effluent before it merges with the river. “The purpose of adding this aeration system was to protect the ecosystem of the Dommel from the damaging effects of hypoxia,” Flameling explains.

At the wastewater treatment plant, before aeration, nutrients and solids are removed in pre-sedimentation, activated sludge, and clarifying processes. To minimize energy requirements, water is kept at a height that keeps the water moving throughout the plant (Figure 1).

To understand how adding aeration would affect the flow, Flameling conferred with Ronnie Berg, a consultant specializing in process technology and water management at Tauw.



FIGURE 1. Aerial view of the Eindhoven Wastewater Treatment Plant.

“If the water height in an effluent channel is too low, the oxygen transfer is ineffective. On the other hand, if the water height is too high, then there exists the unpleasant possibility of overflow from the aeration channel back into the clarifier, contaminating the outflow,” Berg explains (Figure 2).

Another potential problem is water heights that are too low for the water treatment processes to be operative.

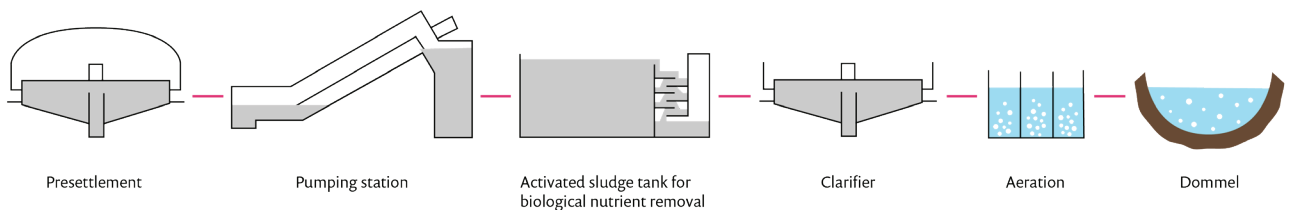

FIGURE 2. Schematic of the water treatment stages of the Eindhoven Wastewater Treatment Plant (WWTP). Aeration is introduced after the clarification, immediately before the reintroduction of the treated water to the Dommel.



FIGURE 3. View of the adjustable dam at the outlet of the aeration channel.

Knowing the flow profile in the effluent channel and associated outflow channel, the water board could determine how best to optimize the system for maximum aeration.

⇒ BUBBLES: GOOD FOR FISH, BAD FOR FLOW?

To fully understand the influence of aeration and dams (Figure 3) on the flow profile and water levels, Berg turned to multiphase flow simulation using the COMSOL Multiphysics® software.

Knowing that an existing channel would be retrofitted for aeration, Berg created the geometry of the effluent channel (Figure 4), including walls, existing guide baffles, and planned locations of the aeration elements.

To characterize the system, Berg played with the arrangement of the aeration units, the heights of different sections of the adjustable dam, and the water level of the Dommel. In this way, he could determine whether there was a benefit to keeping the existing guide baffles in place as well as how the flow profile would change depending on aeration, season, and water level of the Dommel.

Berg set up the fluid flow model considering a highly turbulent regime and dispersed bubbles. Using the Bubbly flow, k-epsilon interface available in the software, Berg was able to capture the effect of aeration on the flow profile. By modeling the bubble-induced turbulence and tracking the effective gas density, he was able to analyze the additional resistance created by the bubbles and the induced spiral flow in the channel.

In a set of CFD simulations, Berg explored the effect the Dommel's water

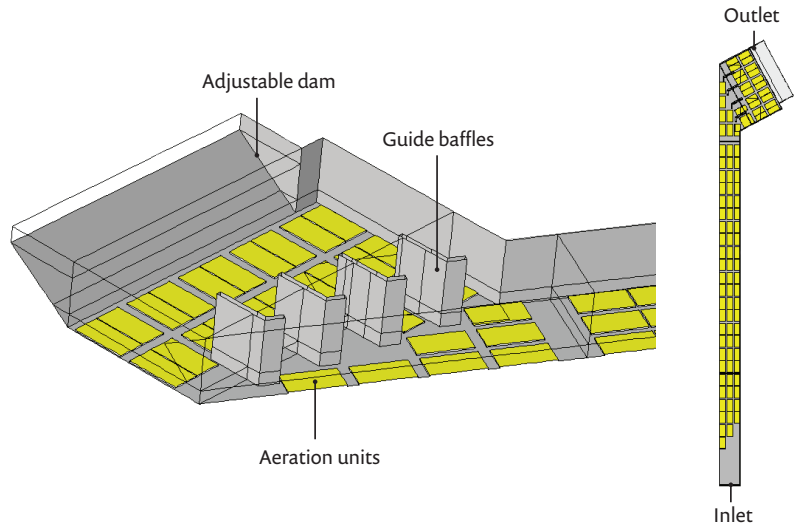

FIGURE 4. Geometry of the aeration channel. Aeration units are represented in yellow.

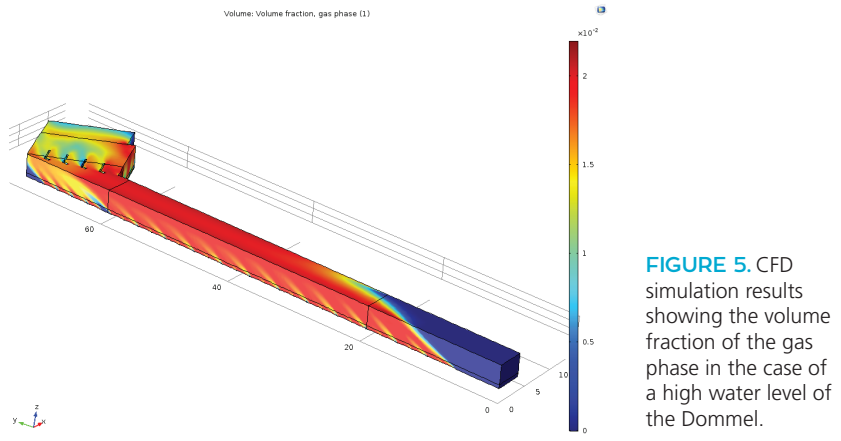

FIGURE 5. CFD simulation results showing the volume fraction of the gas phase in the case of a high water level of the Dommel.

level on the flow profile. He was also able to determine the volume fraction of gas at any location throughout the channel, making it possible to understand the effectiveness of the aeration system (Figure 5).

Berg also evaluated the performance of the virtual aeration unit in dry weather, when the water level of the Dommel river is low. In the case of a low flow rate, all of the sections of the adjustable dam are in place, leading to some backflow (Figure 6).

Berg's analysis of the flow profile, with varying water levels, dam heights, and

aeration, ultimately led him to several findings. He learned that in the case of high effluent flow rates, aeration has little influence on the flow profile. In the case of dry weather, the aeration does affect the flow profile. The resistance created by the aeration is relatively low, leading to

“Simulation enables us to adjust the parameters in a controlled way and gave us the flexibility to find the best design before construction. This ultimately enhances the quality of the water leaving the Eindhoven Wastewater Treatment Plant in a cost-efficient way.”

— RONNIE BERG, CONSULTANT, TAUW

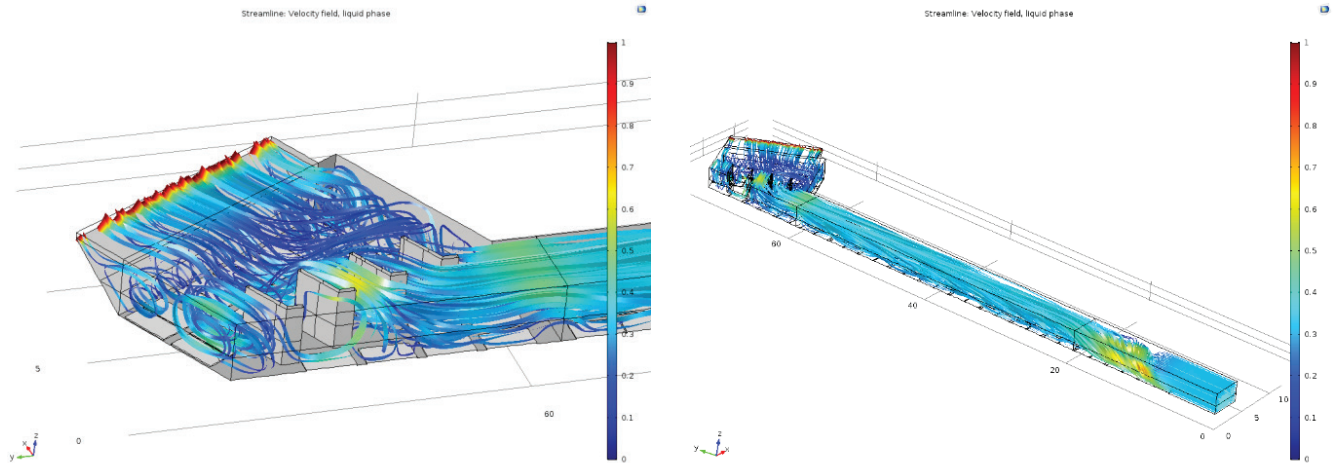

FIGURE 6. CFD simulation results showing the velocity field of the treated water through the aeration system in the case of dry weather.



FIGURE 7. The aeration channel of the Eindhoven Wastewater Treatment Plant in full operation as it improves the oxygen quality of the effluent before reentering the Dommel. Left: View of the adjustable dam at the outlet of the aeration channel. Right: View of the aeration channel from the inlet.

a low risk of water flowing back into the clarifier and contaminating the outflow.

Berg also investigated the effect of activating two out of the three sections of the adjustable dam. When using only two sections, the flow was significantly higher in the outside bend. This resulted in stagnant water near the inside bend and a less efficient aeration process. Overall, the best flow profile was obtained when activating all three sections.

⇒ SIMULATION INFORMS THE DESIGN PROCESS

Based on his comprehensive CFD analysis, Berg made recommendations to the Dommel Water Board, advising not to remove the guide baffles. He also recommended placing the upstream aeration elements in a linear

configuration in order to minimize the construction costs while satisfying water quality requirements.

“Simulation enables us to adjust the parameters in a controlled way and gave us the flexibility to find the best design before construction,” says Berg. “This ultimately enhances the quality of the water leaving the Eindhoven Wastewater Treatment Plant in a cost-efficient way.” The operating aeration system is shown in Figure 7. “The intended effect of the aeration system is now being observed, to the benefit of the river's ecosystem,” says Flameling. The efficiently designed aeration unit will support the ecosystem and the people who rely on the Dommel river for years to come. ❖



Ronnie Berg, of Tauw.



Tony Flameling, of the Eindhoven Water Board.

MULTIPHYSICS MODELING IN THE BIOPHARMA INDUSTRY

At Amgen, a diverse portfolio of multiphysics simulation apps are used to streamline processes, enhance workflows, and ensure the safety and efficacy of drug products.

by **ZACK CONRAD**

To deal with multiple drug modalities, functions, and stages of commercialization, the diverse modeling and simulation tools in the biopharmaceutical industry need to provide considerable breadth with sufficient depth.

Amgen, a leading multinational biopharmaceutical company, uses multiphysics simulation as a tool in their arsenal at any point in their drug production processes to ensure drug efficacy and safety. Their various products have treated serious illnesses in millions of people around the world. But behind every product is a plethora of processes, and Amgen employs a diverse portfolio of process models to enhance their workflow. In an industry where process modeling is more prevalent than product modeling, a portfolio such as this is key. Pablo Rolandi, director of process development at Amgen, has overseen the use of the COMSOL Multiphysics® software as a platform modeling tool for his workforce. “COMSOL is a mature platform with modern design principles,” Rolandi explains. “With a streamlined and easy-to-use interface and GUI and both single and multiphysics capabilities, we can create a great diversity of tools.” As various problems in the development phase arise, Rolandi and his team turn to multiphysics modeling as a solution. In many cases, these solutions are also accompanied by the development of simulation apps, which can be

created directly from the model via the Application Builder. By operating a specialized user interface, the end user can still benefit from the insights provided by simulation results, even if they are not experts in modeling. For the last year and a half, they have developed app packages that are streamlined, communicable, and easily deployed to serve corporate functions in process development, operations, and R&D.

⇒ ELIMINATING BOTTLENECKS IN PRODUCTION

The optimization of a drying process serves as a great first example where Rolandi’s team developed a custom app to help solve a production workflow issue. This case centered on relocating the manufacturing process of a small molecule drug substance from a contract manufacturing organization

(CMO) to Amgen’s plant in Singapore. In the midst of this, drying operations, isolations performed by an agitated filter dryer (AFD) in a process similar to the one in Figure 1, were identified as potential bottlenecks in the production facility. Naturally, a bottleneck can pose a substantial risk to meeting product demand, so Rolandi and his team set out to model the drying operations and streamline the process. Because the CMO used a different type of dryer for the first three steps of the process, shown below in Figure 1, they lacked sufficient characterization data from these isolations to accurately model it and identify the impact of changing operating conditions.

Known properties of the system included material properties; geometric properties of the equipment; and operating conditions, including moisture

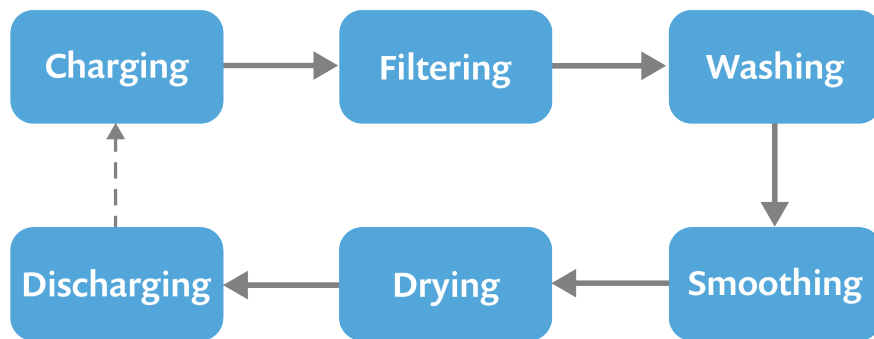

FIGURE 1. Basic steps in a typical batch filtration and drying process for the isolation, or physical separation, of a chemical substance.

content, temperature, pressure, and whether agitation is involved. Rolandi, however, still needed to determine two critical factors: the evaporation rate and the diffusion coefficients of the new AFD. To accomplish this, extensive data acquisition was performed and, using multiphysics simulation, they manually estimated the regressed parameters to characterize the model. Once this was completed, a simulation app that calculates drying times was created and deployed to process engineers changing production sites in the pivotal phase. This played a significant part in giving end users the opportunity to visualize the impact of altered operating conditions, as shown in Figure 2. It was ultimately discovered that the combination of agitation with a heating plate reduced the time to dry, thus helping mitigate the bottleneck and increase efficiency.

⇒ ENSURING STERILIZATION STANDARDS ARE MET

In another situation, one of Amgen’s production teams encountered an issue with sterilization. Compounds from manufacturers are transported in primary containers. These are often vials, and must be sterilized to a certain standard to be classified as a novel container, as bacteria in drug products can pose tremendous health risks. However, the standard sterilization protocol, which involves the diffusion of ethylene oxide as the main transport mechanism, was not meeting the requirements for a novel container.

Naturally, the sterilization process needed to be tweaked, but rather than undertake undue experimentation and costly iterations of trial and error, Rolandi and his team took to simulation to model the ethylene oxide’s diffusion through the vials.

The app featured options to select permeation and contamination boundaries, input solubility and diffusivity constants, and generate time-dependent concentration profiles of the ethylene oxide, (Figure 3). Process engineers could then use the apps to determine if concentration levels were high enough to warrant sufficient sterilization. As a result, experimentation was either reduced or avoided altogether and the program was accelerated by a number of months. “In the end, it was much more efficient to just create simulation apps,” Rolandi said.

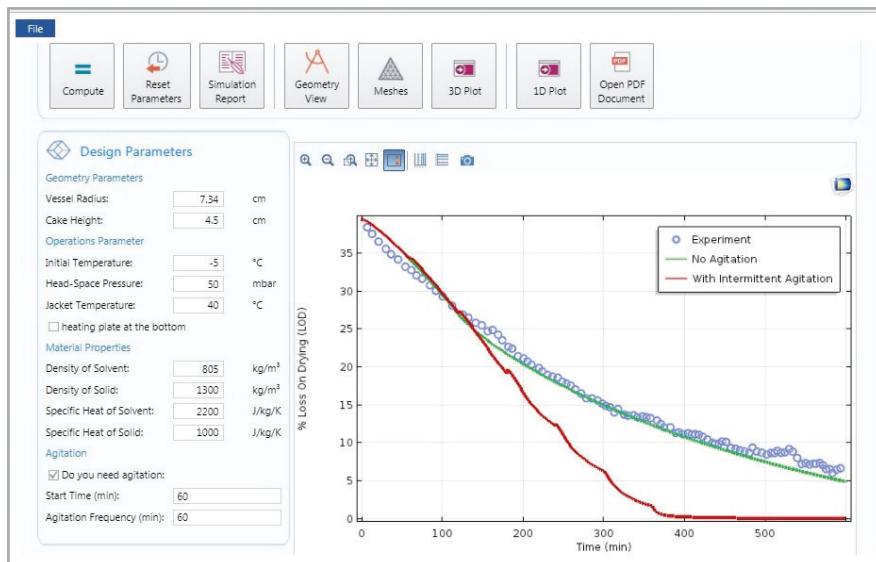

FIGURE 2. Simulation app that calculates drying times for models with no agitation (green) and intermittent agitation (red) and compares them with an experimental result.

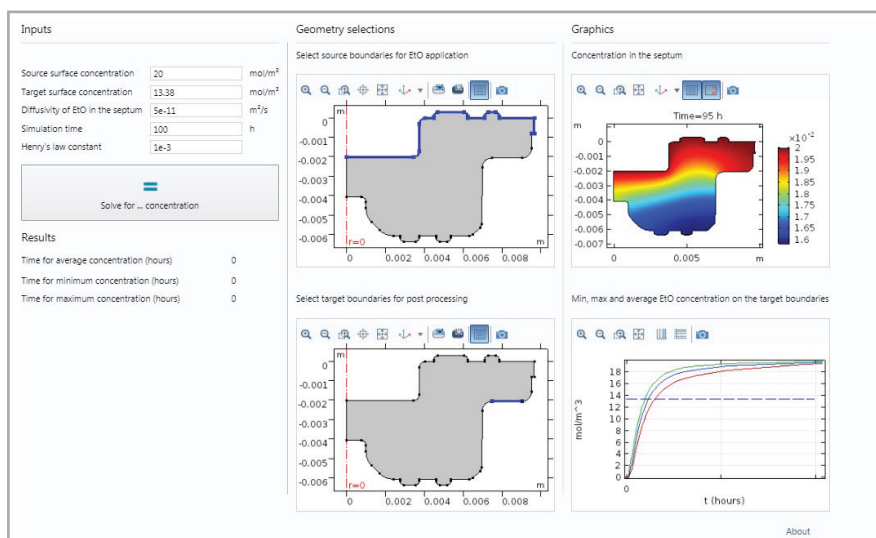

FIGURE 3. This sterilization process app calculates the concentration of ethylene oxide.

⇒ BEYOND SIMULATION

“I’m very keen on thinking beyond simulation about the development and integration of very advanced applications and techniques,” says Rolandi. “I think there is a strategic challenge with that and we are just getting started.” One of his goals is to incorporate uncertainty into their models. In practice, parameters are rarely exact and operating conditions are variable. Integrating these variations into their simulations can lead to more predictive results that can be better understood in context.

For example, Rolandi and his team are working on an autoinjector, a device that injects medicine into a patient without a physician having to administer it. A critical aspect of injections is the time of delivery; this needs to be controlled very precisely in order for the administered drug to perform as intended. The issue is that the delivery time depends on a number of factors, all with varying degrees of uncertainty, including the container geometry, the viscosity and volume of the drug, the spring constants of the injector, and the friction constants of the plunger. If the uncertainty in these

factors is not accounted for, a simulated time of delivery will have an unknown variance, thus giving no information on its potential to be precisely controlled. In process modeling, it is invaluable to create a probability distribution of the expected outcomes in order to better understand how the system will behave.

To gain a better grasp of how the uncertainty of these parameters propagates, Rolandi and his team used multiphysics simulation to run a global sensitivity analysis on the system and rigorously quantify the effect of factor variability. The analysis determines a sensitivity index for each parameter, which is a fractional attribution of the variance in response to that parameter. What they found was that the viscosity of the product, the spring constants, and the needle geometry accounted for 90% of the variance in injection time, allowing them to greatly simplify their model. Because only a few parameters have significant impacts on the injection time, it is much easier for them to manage uncertainty and risk through robust specifications to component providers.

Similar to their other solutions, the injection time model was packaged into a user-friendly and easily deployed simulation app. The app, shown in Figure 4, features user-defined input distributions, runs an uncertainty and sensitivity analysis, writes an automated report, and displays model documentation. The app has delivered cost savings and speed gains and fostered more effective management of uncertainty throughout the entire process.

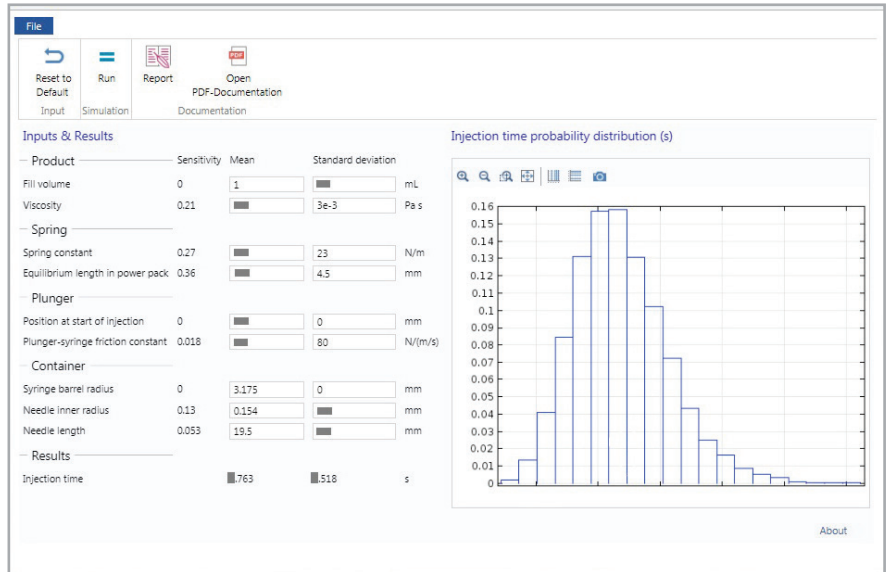

FIGURE 4. Autoinjector model simulation app that shows an injection time probability distribution. Proprietary data have been hidden.

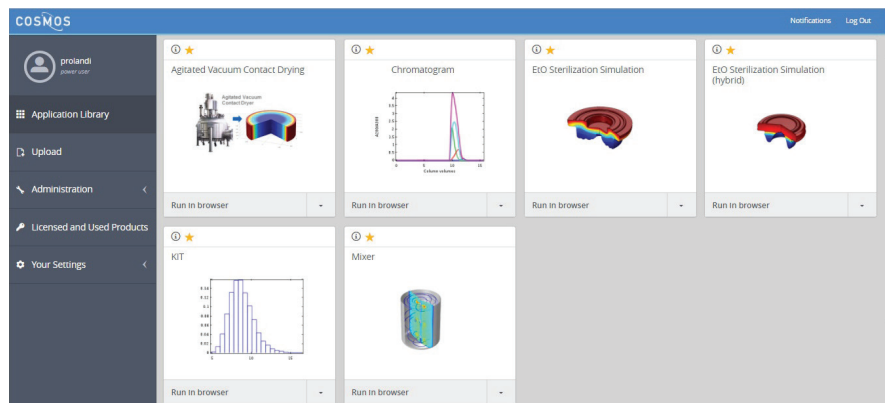

FIGURE 5. Amgen has personally branded their COMSOL Server library, naming the system COSMOS.

⇒ APP DEPLOYMENT

Amgen also takes advantage of a local installation of the COMSOL Server™ product to increase accessibility for their employees. “We have an array of applications that we really want to deploy to everybody at Amgen,” Rolandi says. “At the moment, there are about a dozen applications and those are being used today across the organization in a way that I am

quite proud of, and COMSOL enabled us to do that.” With COMSOL Server, app deployment is trivial and lifecycles can more effectively be managed. Users can simply log in via a web browser to access the application library developed by Rolandi’s team. They also have plans to increase the sophistication within their system by moving away from manual entry and thinking of COMSOL models as “compute kernels.” These can be repurposed with the help

of advanced algorithms in a number of high-impact model-based studies, which would mark a major step in implementing enterprise-level modeling that delivers true business value to a large user base and many stakeholders. ❖



Paulo Rolandi, director of process development at Amgen

“At the moment, there are about a dozen applications and those are being used today across the organization in a way that I am quite proud of, and COMSOL enabled us to do that.”

— PABLO ROLANDI, DIRECTOR OF PROCESS DEVELOPMENT AT AMGEN

LIGHTWEIGHTING WITH ALUMINUM: CORROSION APPS GUIDE LEADING DESIGN

Scientists at the National Research Council Canada (NRC) are using multiphysics simulation apps to minimize the risk of galvanic corrosion in new designs and advance aluminum adoption in vehicle lightweighting.

by SARAH FIELDS

Cars have been shedding pounds in recent years, as manufacturers and consumers increasingly prioritize efficiency and environmental protection. The reduction of a vehicle's weight by one tenth can boost the fuel efficiency of a vehicle by as much as 8%. To accomplish this, manufacturers know they must combine conventional materials for car structures and bodies, such as structural steel, with lighter materials. Aluminum (Figure 1) is a prime candidate for such efforts, as it

is one third the density of steel, weather resistant, highly recyclable, and has excellent formability and crashworthiness.

However, developing a vehicle with both steel and aluminum alloys comes with many challenges. Among these are developing cost-effective mass production technologies; achieving multimaterial assembly using aluminum for parts originally designed to be made with other materials; and mitigating the risk of galvanic corrosion (Figure 2)



FIGURE 1. A high-pressure die casting (HPDC) aluminum alloy.

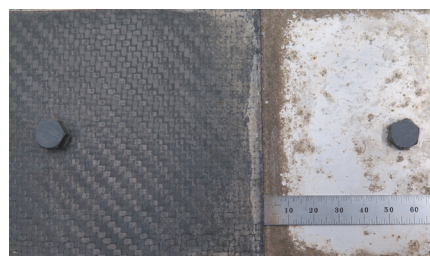

FIGURE 2. Top: Galvanic corrosion damage induced on a multimaterial overlap assembly made of a carbon-fiber-reinforced polymer (CFRP) and a 6000 series aluminum alloy after one year of in-service exposure on a vehicle. Bottom: Typical mounting of samples on a vehicle for in-service exposure testing.

due to dissimilar metals in contact in the presence of an electrolyte, such as de-icing salts applied on roads.

Danick Gallant, technical leader in corrosion activities conducted by the NRC's Automotive and Surface



From left to right: Richard Menini, Mario Patry, Sandy Laplante, Amélie Ruest, Marc-Olivier Gagné, Axel Gambou-Bosca, Philippe Tremblay, Stéphan Simard, Danick Gallant, and Alban Morel at National Research Council Canada, Aluminium Technology Center.

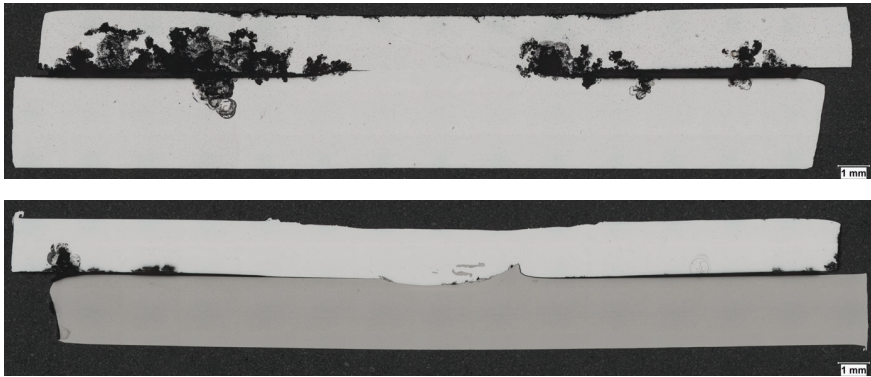

FIGURE 3. Cross-sectional view of multimaterial friction-stir welded (FSW) assemblies after a 100,000 km road exposure between a wheel and a mud flap. Top: Dominant crevice mechanism in a AA7000 series to AA6000 series FSW assembly, Bottom: Dominant galvanic corrosion in AA5000 series to stainless steel 300 series FSW assembly.

Transportation Research Center, supports companies in the development of corrosion-resistant components and assemblies. For a single joint geometry, the industry is currently facing different corrosion-related challenges, from crevice to galvanic corrosion (Figure 3). The NRC, through its ALTec multiclient aluminum R&D collaboration group (Figure 4), is working to advance aluminum in lightweighting and supports the transportation industry in understanding, mitigating, and implementing practical solutions to these issues.

Despite the variation in core business competencies of ALTec member companies, corrosion projects consistently rank highly in the priorities of members. The ability to predict the corrosion of an assembly is critical, as manufacturers of aluminum sheets need to ensure that their products are used correctly to maintain the desired requirements, such as reliability. Similarly, auto manufacturers need their products to perform well and hold up over time.

⇒ AVOIDING GALVANIC CORROSION

There are some general rules to which auto designers can adhere to in order to mitigate galvanic corrosion. These include (1) staying away from a large cathode-to-anode ratio, (2) following the galvanic compatibility chart, (3) avoiding any direct contact between dissimilar metals, and (4) painting both materials to be put in contact, or the cathode only, but never the anode only. However, in

practice, applying each of these rules may be virtually impossible. An example is the difficulty in eliminating metal-to-metal contact when using mechanical fasteners, which are becoming more and more relevant in the context of dissimilar

materials assembly.

Physical testing, which includes in-service road exposure, cyclic corrosion, and electrochemical tests, is still needed though as it can help shed light on the behavior of more complex systems. Examining on-vehicle exposure is time consuming and expensive, standard cyclic corrosion procedures tend to overestimate galvanic corrosion risks, and electrochemical tests become difficult to interpret if several materials are involved in complex geometries.

Researchers have found that multiphysics simulation is the best strategy for combining and synergizing results from physical testing, resolving design challenges before full-scale physical prototyping, and accelerating the development of a corrosion-resistant design.

⇒ CORROSION MODELING OF MULTIMATERIAL ASSEMBLIES

Gallant and his team leverage the information gained from in-service,



FIGURE 4. Members (left) and partners (right) of the multiclient aluminum R&D collaboration ALTec group (as of March 19, 2018).

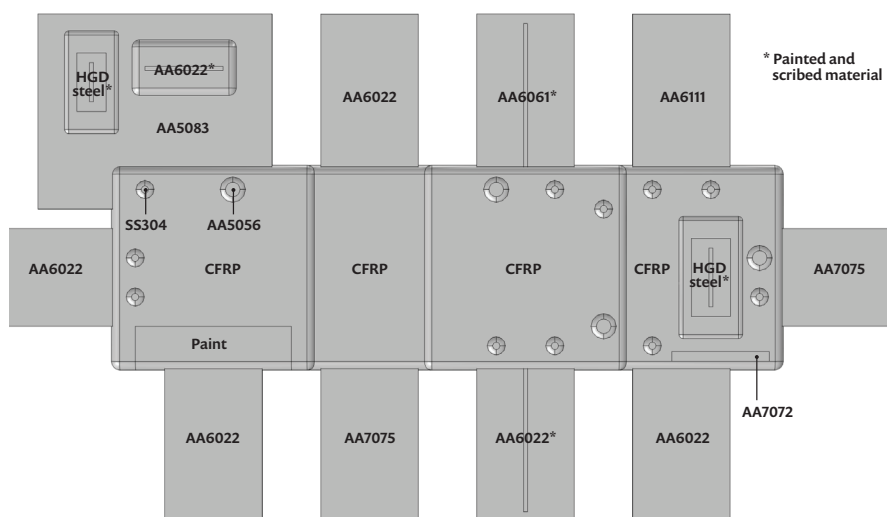

FIGURE 5. Multimaterial assembly built to demonstrate the relevance of using numerical simulation of corrosion to raise red flags for inappropriate designs.

cyclic corrosion, and electrochemical tests within the COMSOL Multiphysics® software to create flexible mathematical models capable of predicting corrosion behavior. “In order to build virtual prototypes that represent what happens in real life, the developed models are calibrated with a series of sensors mounted on vehicles,” explains Gallant. The team has access to high quality data from which the most relevant information and knowledge can be extracted using advanced data analysis procedures and machine learning models. Each piece of data is taken into account, including the surface temperature under the vehicles, time-of-wetness, composition, conductivity of deicing salts deposited on vehicles surfaces, vehicle speed, and GPS position.

At the beginning of the initiative, Gallant considered different software tools for the simulation of corrosion.

He found that the COMSOL® software allowed him to specify and control all properties of the model, rather than operating as a “black box” with controlled inputs but unknown unchangeable internal calculations. “The corrosion modeling capabilities of COMSOL, combined with the ability to import geometries from other software is powerful because we can test different galvanic combinations. This information tells us which designs need a geometric change before moving on to building a physical prototype,” Gallant explains.

As a case study and laboratory demonstration for potential NRC clients, Gallant and his team built a complex assembly made of more than 10 different materials and coatings (Figure 5). Corrosion damages

“The corrosion modeling capabilities of COMSOL, combined with the ability to import geometries from other software is powerful, because we can test different galvanic combinations. This information tells us which designs need a geometric change before moving on to building a physical prototype.”

— DANICK GALLANT, TECHNICAL LEADER IN THE AUTOMOTIVE AND SURFACE TRANSPORTATION RESEARCH CENTER

experienced during an aggressive four-day laboratory procedure correlate well with the simulation results, illustrating the capability of the NRC corrosion models, built in COMSOL Multiphysics software, to predict the corrosion behavior of a complex multimaterial assembly.

Time-dependent studies in the COMSOL Multiphysics software were carried out to determine the thickness loss of a sacrificial anode throughout the laboratory corrosion exposure period (Figure 6). The experimental and simulation results are in good agreement. As observed from both experimental data and simulation results, the dissolution of the aluminum rivet is inhibited on its left side, since a larger and more active aluminum component is located next to it (Figure 7). On its right side, the rivet corrodes due to the presence of the noble CFRP material. Again, the team found that the simulation describes the experimental observations well.

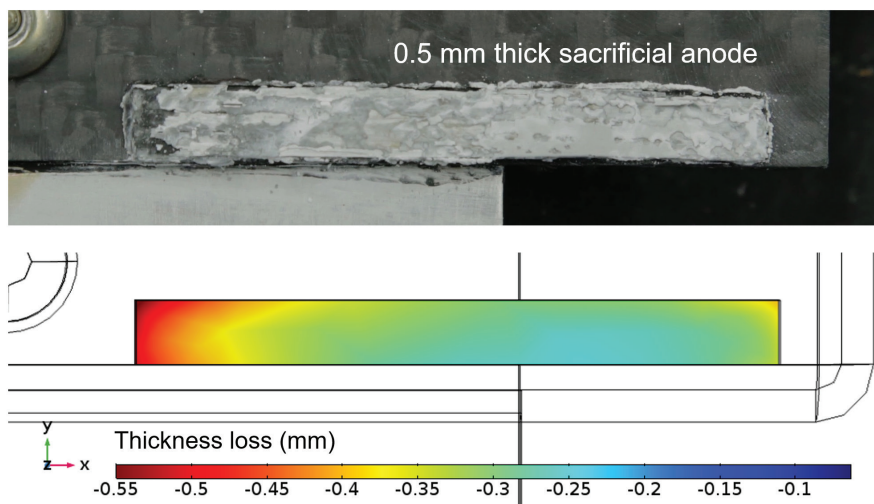

FIGURE 6. Time-dependent analysis (bottom) used to determine the thickness loss of a sacrificial component throughout the laboratory corrosion exposure (top) period.

⇒ APPS SUPPORT LEADING DESIGN

After creating the numerical model, Gallant uses the Application Builder tool in the COMSOL Multiphysics software to create a simulation app that can be shared with colleagues at NRC and ALTec members. Using a local installation of the COMSOL Server™ product (Figure 8), he can quickly deploy apps through a web interface, administer users, apply customized branding, and share updates when needed.

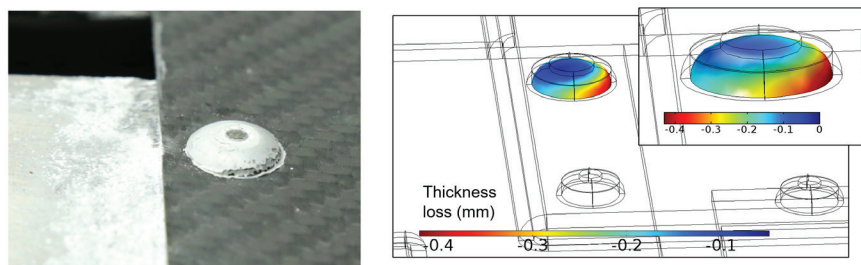

FIGURE 7. Time-dependent analysis (right) used to determine the dissolution of the aluminum rivet (left).

His colleagues and clients can access the apps at any time using their web browser and provided login information.

An example of a simulation app used to calculate the galvanic corrosion that will occur in a complex multimaterial assembly is shown in Figure 9. The user of the app can select the components of the assembly and define the electrolyte thickness, convection, and temperature. When running the app, the user can visualize the electrolyte potential, current density, and the electrode thickness change. Customized results files can also be exported for further data analysis with MATLAB® or RStudio® scripts written by the NRC and adapted to clients' specifications.

Apps are also facilitating the communication between the engineer responsible for the performance of the entire vehicle and the corrosion engineer. Before apps, the former might not see the merit in switching to a different geometry or changing out a material if it deviates from what they've done in the past or is more expensive. But with the arrival of apps, the corrosion engineer can provide a more concrete rationale to the design engineer and clearly demonstrate where and why corrosion will occur.

"Our next steps are to give ALTEC members the ability to select the assembly location on the vehicle within the app, which will give them a better representation of the electrolyte in the model and give them an even better prediction tool. Possibilities offered by the COMSOL Server are almost infinite and its flexibility makes it easily adaptable to specific clients' requirements," Gallant explains.

⇒ WINNING THE LIGHTWEIGHTING RACE

With multiphysics simulation and apps, it is easier to select the right materials and geometry throughout the design process, greatly aiding the implementation of aluminum in new lightweight designs. The team at National Research Council Canada and their industrial partners will continue to pave the way for more innovation in aluminum manufacturing, supporting to the game-changing movement of aluminum adoption in automotive lightweighting. ❖

Email: Danick.Gallant@cnrc-nrc.gc.ca

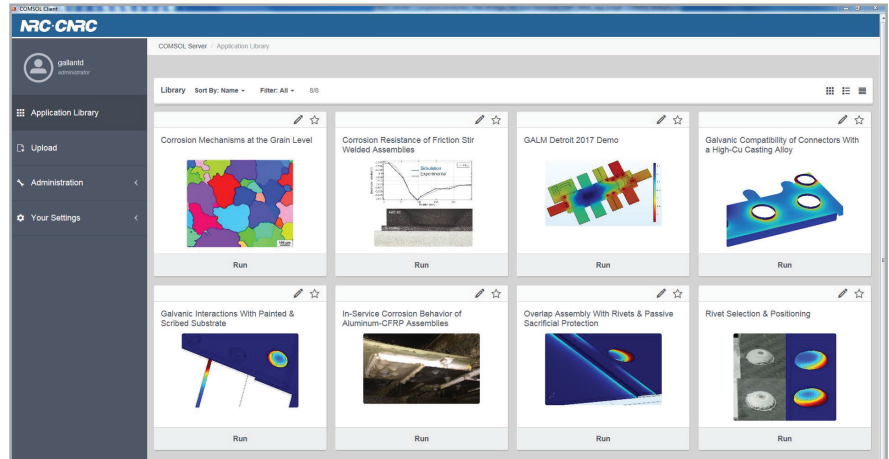

FIGURE 8. View of NRC-branded COMSOL Server™ accessed from a web browser.

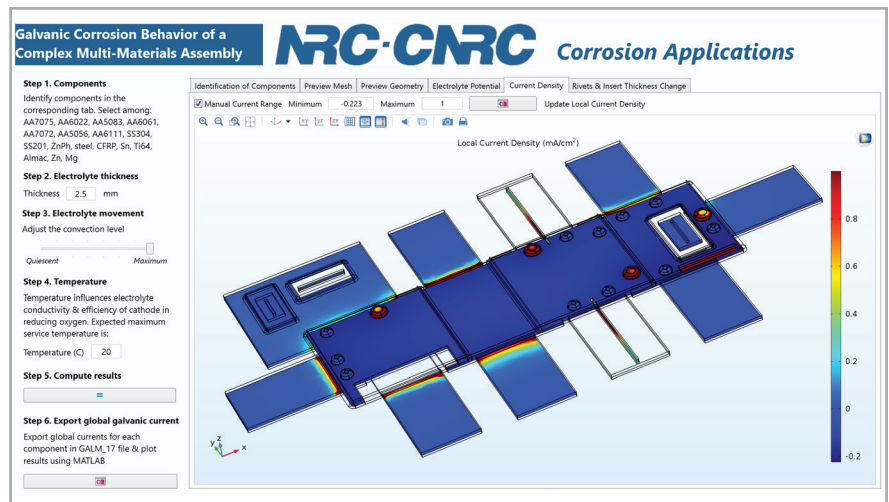
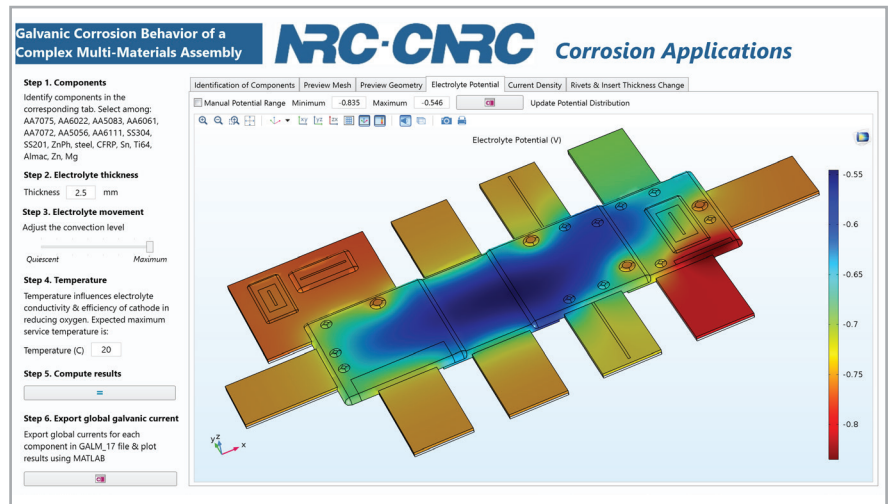

FIGURE 9. Simulation app for determining the galvanic corrosion behavior of a complex multimaterial assembly. Top: Visualization of the electrolyte potential across the assembly. Bottom: Visualization of current density throughout the assembly.

Magnetic Transmissions Increase Lifespan of Offshore Wind Farms

At Sintex, multiphysics simulation is used to develop and analyze non-contact magnetic couplings. Such systems will offer significantly improved reliability, medium separation, and finding crucial roles in offshore wind turbines and chemical pumping applications.

by **ZACK CONRAD**

Whether it's an automotive engine, a wind turbine, or something as straightforward as a wristwatch, torque conversion and the transmission of rotational power are important for various technological applications.

Traditionally, transmission is achieved through a series of collinear mechanical gears or shafts that transfer torque and thus power. But mechanical transmission has inherent limitations, namely a susceptibility to friction, wear and tear, and overload because of the continual contact. As the scope of technology continues to expand into more hostile and unforgiving environments, these limitations can be of extreme detriment. In places of limited accessibility and harsh conditions, replacing failed transmissions is a challenging and tremendously costly task.

⇒ POWER TRANSFER WITHOUT THE FRICTION

Engineers at Sintex have developed an innovative alternative that provides robustness and reliability: magnetic couplings. The essence of these couplings is that the power transfer is achieved via magnetic forces, rather than mechanical forces, therefore removing contact and wear and tear and drastically improving the lifetime of the transmission system. Power is transmitted through a torque coupling between concentric arrays of permanent magnets (Figure 1). A power source causes one drive to rotate, while the coupling of the magnetic fields between the drives causes the other to rotate with the same speed. This system allows rotational power to be transferred

just as in mechanical transmissions but without the friction and risk of overload. If the torque transferred from the motor is too high, the coupling will limit excessive amounts from being applied to the shaft. This limit prevents the shaft from undergoing torque values greater than what it was designed for, thus assuring operation in its intended conditions.

Sintex's noncontact magnetic couplings are ideal for their customers in offshore wind turbines and industries that employ complex pumping systems. Offshore wind farms are becoming increasingly integral with their generation of electricity, but require high levels of reliability in their components because of how difficult these parts are to repair. In individual turbines, magnetic couplings transfer energy from the motor to water pumps that cool the electrical components 24 hours a day. As these offshore systems involve such remote installations, preventative maintenance or repairs are burdensome and expensive, making the reliability of magnetic couplings invaluable. In addition, the air gap between drives easily accommodates the insertion of a separator can (Figure 2), allowing for media separation and closed systems for use in chemical and food industries. Pumping systems that are completely devoid of leakage are critical for the transport, mixing, stirring, and grinding of chemicals and toxic materials.

⇒ MAGNETIC COUPLINGS ACROSS INDUSTRIES

Sintex's magnetic couplings are

employed in a diverse range of applications and must be individually tailored based on given constraints, which can include weight or material requirements and geometric restrictions. During the design process, engineers need to be able to interchange shapes and materials of magnets to meet their customers' requirements without having to build physical prototypes, as magnetic prototyping is costly and time consuming. In order to save time, Sintex uses multiphysics simulation to characterize configurations and provide virtual prototypes of designs. Flemming Buus Bendixen, a senior magnet specialist at Sintex, has used finite element analysis for twenty years, with COMSOL Multiphysics® as his primary tool of the last decade.

"One of the big advantages of COMSOL from my point of view is that you can do many kinds of simulations; you can include many kinds of physics and these physics can interact with each

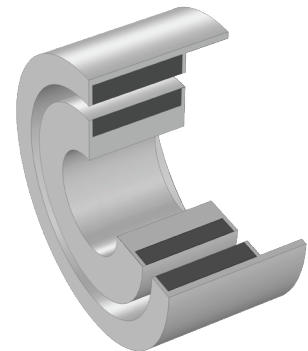

FIGURE 1. Schematic of a magnetic coupling.

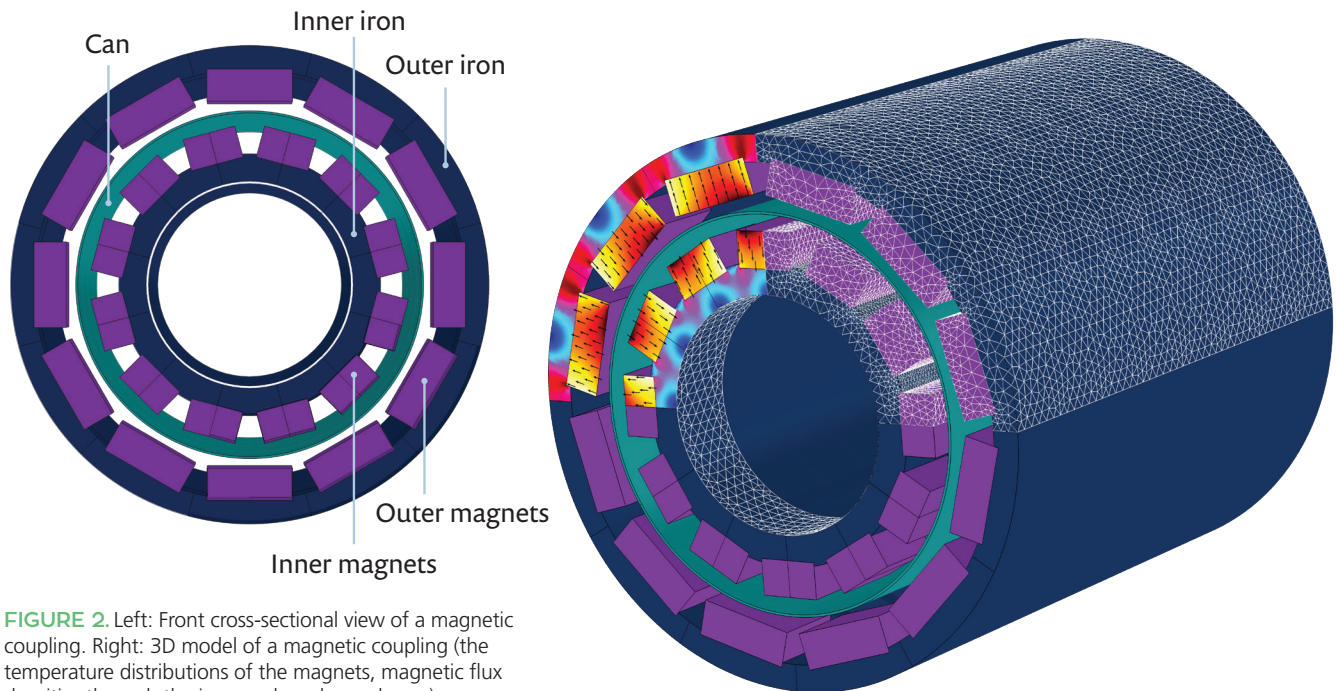

FIGURE 2. Left: Front cross-sectional view of a magnetic coupling. Right: 3D model of a magnetic coupling (the temperature distributions of the magnets, magnetic flux densities through the iron, and mesh are shown).

other,” said Bendixen. His team has a plethora of incredibly thorough and complex models and because of the intense verification and validation that the models undergo, the team now places full trust in them. This not only saves time but also reduces the price for customers and allows a greater emphasis to be placed on the finer details.

⇒ ELIMINATING RISK WITH NEW DESIGNS

Using multiphysics simulation Bendixen studies the interactions between the drives of a magnetic coupling and calculates the torque transmission from the outer drive to the inner drive. As the primary purpose of magnetic couplings is to transmit maximum torque and power along an axis, the torque transfer is the most defining characteristic; therefore, it is calculated in multiple ways, including Maxwell’s stress

tensor, postprocessing integral methods, and the Arkkio method. The analysis is verified through experimentation and has yielded errors as small as 1%, speaking volumes to the accuracy of the model. During the development process of a new design, the model can be used to maximize the torque transferred in a specific configuration.

Since permanent magnets and their fields give rise to numerous secondary effects, Bendixen makes a substantial effort to model them. In metals, such as the steel can in this coupling, eddy currents are generated by the external magnetic fields, resulting in electrical losses. “The shifting north and south poles create voltages across the steel; it conducts electricity and this dissipates energy from the system,” explains Bendixen. These are referred to as can losses, which are simulated with post-

processing tools in the software, and need to be reduced as much as possible. The team also recently developed a machine that experimentally tests the can losses of designs and confirms the accuracy of their model to a few percent.

“We are dedicated to capturing the truly nonlinear nature of magnetism, and COMSOL allows us to do just that, assuring optimal magnetization of the array,” says Bendixen. By employing highly nonlinear hysteresis curves and utilizing their own material temperature dependences for magnetic loading, the simulations (shown above) help prevent the permanent magnets from reaching their critical temperature and becoming irreversibly demagnetized, which is paramount to assuring the reliability of their products. “It is very important to know the temperature that the magnets can withstand, and I can calculate this quite precisely,” Bendixen adds. “If the magnets get too hot, they can become partially demagnetized.”

Bendixen takes further advantage of the flexibility of multiphysics simulation having imported Sintex’s library of magnetic materials, allowing for a vast array of custom magnetic configurations.

“One of the big advantages of COMSOL from my point of view is that you can do many kinds of simulations; you can include many kinds of physics and these physics can interact with each other.”

— FLEMMING BUUS BENDIXEN, SENIOR MAGNET SPECIALIST, SINTEX

⇒ THE EASY BUTTON FOR SIMULATION EXPERTISE

Once Sintex was comfortable with the level of complexity in their models, the next step was to broaden their usage and make them more accessible to non-simulation experts. Previously, when sales representatives and other colleagues that were not versed in simulation techniques needed to run tests on designs, they went to Bendixen to have all of the calculations done.

Bendixen created simulation apps based on his multiphysics models and found productivity and convenience of simulation at an all-time high. Sintex currently employs ten different simulation apps with up to twenty different users. The apps are created directly in COMSOL Multiphysics® through the Application Builder tool and can then be accessed via a web browser by connecting to COMSOL Server™. The simplified user interface and straightforward deployment provide ease of use to all of their employees. Select customers are even given access to these apps and their computational power. “I built the apps because some of my colleagues are not so skilled in simulation software and would like to do some system testing and simulations by themselves, and the apps enable them to easily do this,” Bendixen says.

Simulation apps allow the user to vary parameters without having to alter the underlying computational model. “Sales people can change dimensions and perform simulations while they’re on the phone with clients to verify agreement with their specifications within minutes,” says Bendixen. But despite the simplicity of the interface, there is still extensive flexibility to be innovative with design iterations. Sintex’s apps let the user adjust both geometric and magnetic parameters. The model then calculates the critical temperatures of the magnets, remanence distributions, magnetic field flux densities, torque, and can losses. Figure 4 is an example of an app that simulates the eddy currents generated in the separator can. These currents can then be used to calculate the resulting power loss. Now, people at all stages of development can contribute to the design process and help maximize reliability in their products.



FIGURE 3. Standard magnetic couplings.

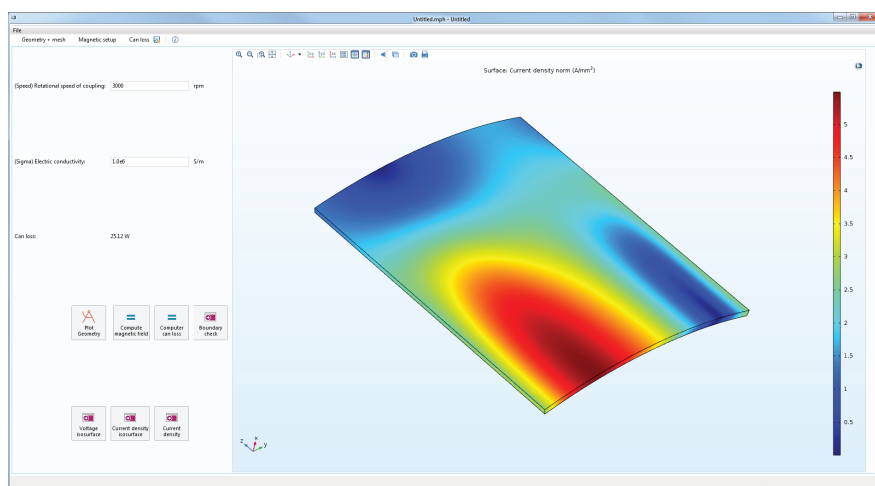

FIGURE 4. This portion of the simulation app models the induced eddy current density in the can and calculates the resulting energy loss.

⇒ LOOKING AHEAD

Sintex is also developing a novel magnetic reluctance gear, which will expand the application range of gears in general. In addition to offering reliable, noncontact magnetic transmission of torque, these gears can alter the speed or torque between drives, allowing for mechanical advantages to be created with fixed gearing ratios. In a unique design feature, these gears will incorporate a single permanent magnet with a magnetization parallel to the shafts, greatly simplifying assembly and enabling a high degree of customization. And with simulation apps involving more people in the analysis process, Bendixen can spend more time making consistent improvements to all of Sintex’s magnetic technologies. ❖



Flemming Buus Bendixen, a senior magnet specialist at Sintex.

Going with the Flow to Optimize Fluid Sensors

Product developers at Endress+Hauser improve the sensitivity of flow sensors for measuring fluid density, viscosity, mass flow, and temperature for applications in the water, food, pharmaceutical, and oil & gas industries.

by **VALERIO MARRA**

Start your car, fill a glass of water from the tap, or drink from a carton of juice, and you're using a liquid that has been carefully extracted, processed, and assessed for quality. The staggering forethought and technology that goes into making such fluids usable by consumers is often out of sight, yet requires precise measurement and monitoring.

When processing pharmaceutical products, how do you tell if a fluid is the high level of quality you seek? If you're working with crude oil, how do you know how much you're extracting? If you're transporting water, how do you know the flow rates and volume distribution?

Questions like these, which impact confidence and bottom lines for water, pharmaceutical, food, and oil & gas companies, are addressed by the manufacturers of flow meters that sit inside pipelines and other equipment. At Endress+Hauser, engineers work tirelessly to develop and maintain accurate sensors for a diverse variety of substances that require different measurement methods.

⇒ MEASURING CORIOLIS FORCES

To determine the properties of a fluid traveling in a pipe, sensors designed at Endress+Hauser measure the effects of the Coriolis force within a device inserted in the pipeline consisting of one or more oscillating measuring tubes.

The tube is excited prior to any fluid entering the device. When a fluid at rest fills the device the tube oscillates uniformly. As soon as the fluid begins to flow through the oscillating tube, the fluid starts to exert a force on its walls. The oscillation of the measuring tube is seen as a rotation around an axis by the fluid particles. Since fluid particles are moving in a moving reference frame, they experience an inertial force acting perpendicular to their direction of motion and to the axis of rotation: the Coriolis force. Since the inlet and outlet sections of the oscillating tube induce opposite rotational motion, the induced forces act to deflect the tube in an asymmetric fashion, causing a phase-shift or time-lag along the tube.

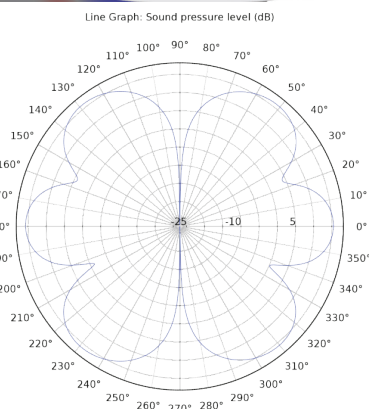
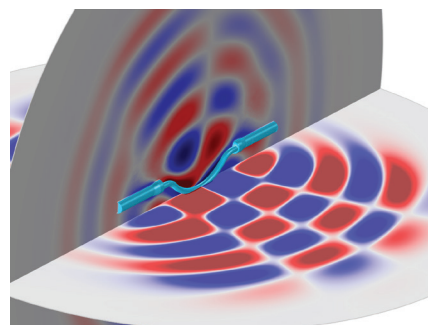
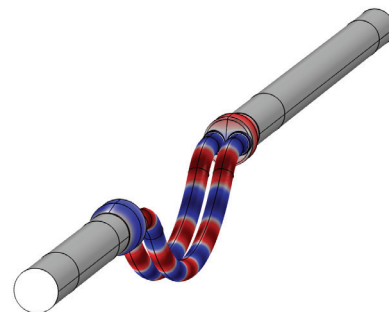

FIGURE 2. Simulation showing the acoustic field in and around the oscillating tube (top and center) and a sound pressure level plot in dB (bottom).

Different sections of the tube begin to oscillate with a time-lag or phase-shift caused by the twisting component in the motion of the pipe. This phase shift and the new oscillating frequency of the tube are a function of mass flow rate in the tubes and the density of the fluid, respectively. Hence the signals from the meter can be interpreted to measure the mass or volume flow and ensure that the desired quantity of fluid is being transported.

Likewise, an increase in fluid viscosity leads to an increase in damping of the oscillations. The oscillating frequency is mainly a direct measure of the fluid density. Oscillations will be faster but

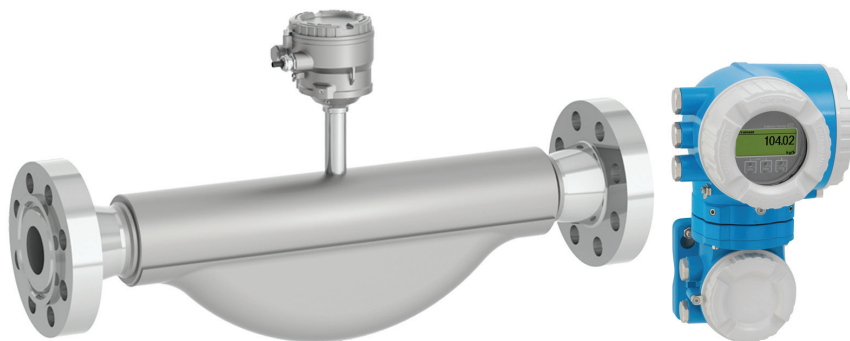

FIGURE 1. Coriolis flow meter designed at Endress+Hauser.

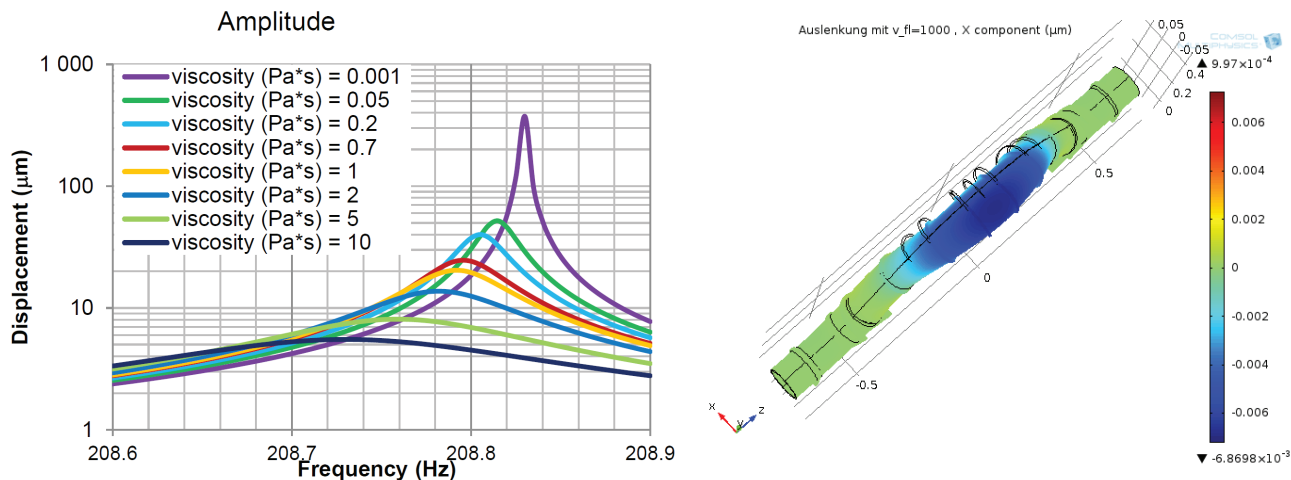

FIGURE 3. Simulation results showing the change in tube oscillating frequency for different fluid viscosities and the resulting mechanical displacement. At right is a visual example of tube deformation due to the oscillating motion.

more damped, for example, with a substance like oil (lower density and higher viscosity) than a fluid like water (higher density and lower viscosity). Measuring the frequency and the damping of oscillations makes it possible to determine density and viscosity and monitor the process quality related to the fluid flow. The same physics effects would apply to an object, oscillating in a moving fluid, such as a cantilever.

⇒ A VISCOACOUSTIC EXAMPLE

Vivek Kumar, a senior expert in numerical simulation at Endress+Hauser Flowtec AG, the branch of Endress+Hauser that manufactures these flow meters (Figure 1), works to improve the performance of their sensors. His modeling work has helped his team understand the acoustic, structural, and fluid flow effects in their flow meters on a deep level. Understanding how the fluid-structure interaction and vibroacoustics affect the

performance of a sensor enabled them to make various design adjustments to improve the performance and quality of the meter.

The team began their numerical analysis with a

“Using simulation we have been able to analyze different cases and ultimately optimize our device design to help our customers characterize material properties for the fluids they are using or extracting.”

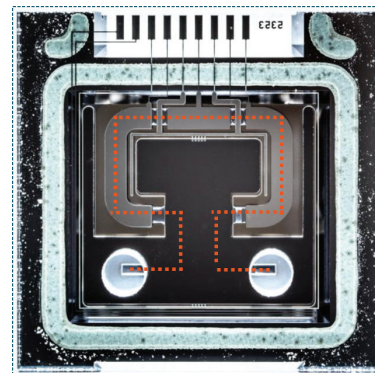
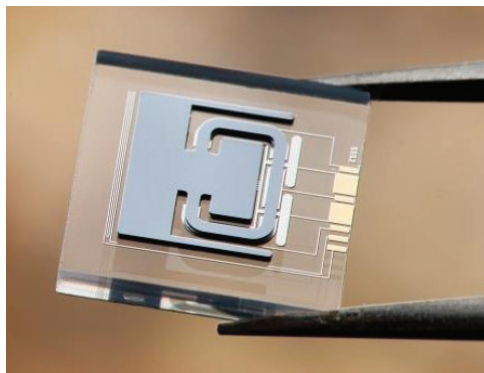

FIGURE 4. MEMS Coriolis chip used for density and viscosity measurements. Left: Complete sensor held by pliers. Right: Chip layout inside the device.

viscoacoustic model to understand the complex viscous damping that occurs when a viscous fluid flows through the oscillating tube. They examined the coupled behavior of structural deformation and acoustic wave propagation, modeling fluid-structure interaction in the frequency domain

in order to predict how the flow meter would respond to different fluids. Figure 2 shows how the sound wave generated by turbulent flow is propagated in the surrounding meter. “With

COMSOL Multiphysics we try to estimate the effect of flow induced noise on the surroundings and the flow meter as well,” the team commented.

They analyzed the effects of fluid viscosity on the oscillating frequency of the tube. Figure 3 shows simulation results predicting the frequency as well as displacement of the tube for fluids of different viscosities. With the ability to simulate and better understand the physical effects that cause a shift in the frequency output of the meter, the team is able to exploit these effects to improve the performance of the meter by filtering out undesired effects, for example. In this case, the variation in the tube damping is utilized to compensate for the viscosity effects on the measured density error.

“We wanted to understand how different fluids would affect the sensor

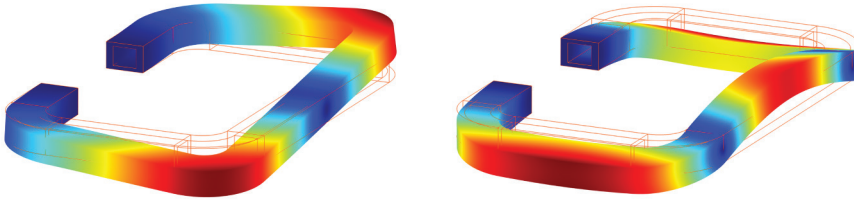

FIGURE 5. Two eigenmodes of the oscillating microchannel. Color denotes the relative displacement levels of different regions of the channel.

performance,” they commented. “Using simulation, we have been able to analyze different cases and ultimately optimize our device design to help our customers characterize material properties for the fluids they are using or extracting.”

⇒ A MICROSCALE EXAMPLE

TrueDyne Sensors AG, a subsidiary of Endress+Hauser Flowtec AG, develops MEMS devices based on a similar concept. They design and test oscillating sensors to measure thermo-physical fluid properties for many different applications. The team develops sensors for specific customer solutions. Therefore, it is of the utmost importance that they know what type of oscillators would provide the best sensitivity for unique cases.

The MEMS Coriolis chip (Figure 4) utilizes a freestanding vibrating microchannel that operates on the same principle as the larger Coriolis flow sensor. Like in the case of Coriolis simulations, a vibration analysis needs to be performed on the microchannel in order to determine fundamental eigenmodes and the oscillation rates of the different ends of the flow channel (Figure 5). This particular sensor is used for evaluating density and viscosity of fluids such as inert gases, liquid petroleum gas (LPG), hydrocarbon fuels, or cooling lubricants. Due to its dimensions, the sensor is suited to measure very small fluid quantities.

One specific challenge occurring in such a small device is the increase in temperature that, in case of electrical failure, could occur through a high voltage applied to the sensor to drive excitation. Given this safety risk, they carried out a thermal analysis (Figure 6) to determine where heat was dissipated in the chip and whether the fluid would

become too hot. It was confirmed that the temperature did not exceed the limit thanks to the vacuum chamber surrounding the flow channel that minimized heat transfer between the electrodes and the fluid.

⇒ SERVING COMPANY AND CUSTOMER NEEDS

Both teams comment on how the flexibility of COMSOL Multiphysics® has been very useful in their R&D work for easily adapting flow meters to function at top performance for a variety of needs. Multiphysics analysis provides them with insight that reduces the overall time and effort spent on testing

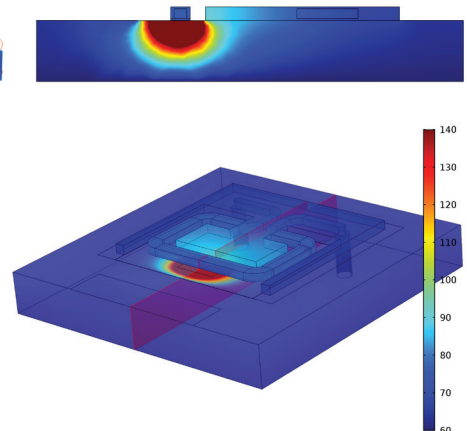
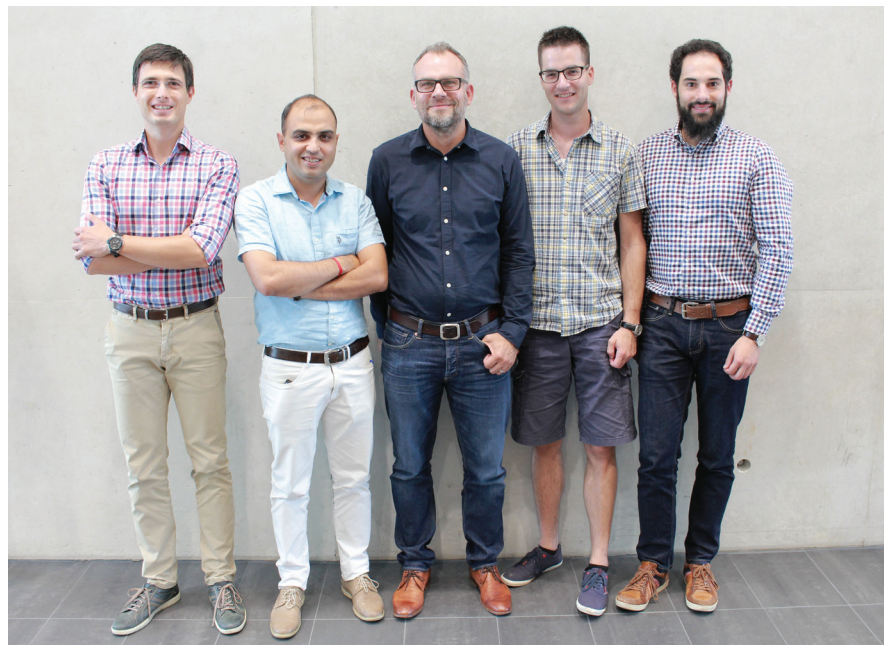

FIGURE 6. Thermal results showing temperature in the MEMS Coriolis chip.

and prototypes, and allows them to produce the highest quality sensors.

Christof Huber is inspired by his work when he sees the way his modeling leads to changes to the device designs that improve the experience of Endress+Hauser customers. “These tools are used to solve customers’ problems. We see our innovation in practice when working in the field. We see the return as the reason we are doing this.” ❖



From left to right: Anastasios Badarlis, Dr. Vivek Kumar, Dr. Christof Huber, Benjamin Schwenter, and Patrick Reith.

E+H Flowtec AG is a company of the Endress+Hauser group, headquartered in Reinach, Switzerland. Truedyne Sensor AG is a subsidiary company of Endress+Hauser Flowtec AG.

Endress+Hauser 
People for Process Automation
truedyne 

OPTICAL COOLING AND THERMOMETRY AT THEIR ABSOLUTE FINEST

A collaboration between the National Institute of Standards and Technology and the University of Maryland used numerical simulation to model nanoscale optomechanical beams that can be used for absolute thermometry and ultra-sensitive force sensing. Such devices, which couple light and sound, are envisioned to play crucial roles in pharmaceutical, chemical, and electronics industries.

by **ZACK CONRAD**

Image credit: Emily Edwards/Joint Quantum Institute.

To exploit some of the deepest principles of quantum mechanics on a macroscopic scale, researchers at the Joint Quantum Institute developed microscopic structural beams whose behavior is affected by light striking them. The coupling between mechanics and optics has potentially powerful applications; such an optomechanical system shows tremendous promise for the development of absolute thermometry and ultra-sensitive force sensing. The research is performed by a collaboration between the National Institute of Standards and Technology (NIST) and the University of Maryland has paved the way for these applications to come to fruition.

The optomechanical system features structural beams made of silicon nitride, a transparent material prevalent in the electronics and photonics industries, and is truly microscopic; the beams are around twenty microns long. Because of their transparency, light can be sent down the beams, and a row of holes etched into them allows their optomechanical properties to be manipulated, which can then be harnessed in remarkable ways.

The ingenuity of the system stems from the fact that the beams' vibrations are directly dependent on the surrounding temperature and Boltzmann and Planck's fundamental constants of nature, meaning

that they can be used as thermometers with absolute accuracy and without any calibration. The potential applications for these thermometers are wide-ranging and include temperature sensors for electronics and biology, where harsh environments can severely hamper calibration and sensitive measurements are critical.

"Biological processes, in general, are very sensitive to temperature, as anyone who has a sick child knows. The difference between 37 and 39 degrees Celsius is pretty large," said Jake Taylor, a fellow at the Joint Quantum Institute. According to Taylor, potential applications will be most valuable where temperature changes must be measured in "as small an amount as possible."

⇒ QUANTUM FLUCTUATIONS GIVE AWAY TEMPERATURE

Delving down to the microscopic level of these beams, vibrations are caused by two sources: thermal motion and quantum fluctuations. Thermal motion-induced vibrations are typical in any material; they are simply caused by basic interactions between gas molecules or sound waves. Quantum fluctuations, on the other hand, are much subtler and arise directly from the Heisenberg uncertainty principle, which states that as the uncertainty in a position measurement decreases, the

uncertainty in its velocity measurement increases, and vice versa. In this case, the quantum fluctuation is used as a built-in absolute scale to calibrate the temperature measurement.

In Figure 1, simulation results show how over one vibrational period, the center of the beam goes from being stretched out as shown, to being compressed inward and then back (the length scale in the figure is greatly exaggerated). The red regions undergo the highest degrees of deformation, while the dark blue regions undergo the least.

To act as an absolute scale for the temperature calibration, the quantum fluctuations need to be detected separately from the thermal fluctuations. However, they are a million times fainter than the thermal vibrations. Tom Purdy, a physicist at NIST, and the collaboration are now able to distinguish quantum mechanical motion from thermally driven motion and tease out the small quantum correlations that are produced in response to optical measurement.

Light striking the mechanical beam and reflecting causes it to recoil, creating minuscule vibrations in the beam. By detecting this motion, the temperature can be derived. "We see a little bit of the quantum vibrational motion picked up in the output of light," Purdy explained,

“The ingenuity of the [optomechanical] system stems from the fact that the beams’ vibrations are directly dependent on the surrounding temperature and Boltzmann and Planck’s fundamental constants of nature; meaning that they can be used as thermometers with absolute accuracy and without any calibration.”

so by carefully analyzing the transmitted output light signals, they can measure temperature without the need for a separate calibration process.

⇒ OPTOMECHANICAL COOLING IMPROVES SENSOR SENSITIVITY

The researchers also foresee applications that employ an optomechanical system in a different manner. Rather than using the beams as a method to measure temperature, they can use the beams as a method to control temperature by diverting heat away from delicate components. A prime example of this is an atomic force microscope (AFM), an ultra-sensitive force sensor that helps create atomic-scale images.

As shown in Figure 2, light travels through the series of holes, with a chance to reflect back toward its source, which depends upon the motion of the two “arms” of the mechanical system. Laser cooling damps the motion in which the arms move in opposite directions (the antisymmetric mode), which improves the performance of the symmetric mode (arms in synchrony). This symmetrical mode is, in turn, modified by the interaction of the small tip with a nearby surface, enabling sensitive detection of the surface properties in a standard AFM setup.

Light can then be used to control the

vibrations of the two arms of the beam and thus the flow of heat. By reflecting light inside the beam in a purposeful way, the beam and tip are cooled. The significance of cooling is that it reduces the thermal noise of the system, making it much easier to see signals and increasing the overall sensitivity of the device.

⇒ THE NEXT CHALLENGE: MANIPULATING LIGHT AND SOUND

A critical step in the development phase of these beams for both applications was understanding the mechanics of their vibrations and their coupling with optics, such as the eigenmodes (both light and sound waves), mechanical damping (including thermoelastic effects and clamping/anchor loss), and strain and electric field distributions. Numerical simulations were run to model such behavior, allowing the researchers to optimize the effect of the coupling between optical and mechanical modes.

One other application in which these nanomechanical beams may find use is in the production of metamaterials, complex composite materials that are specially designed to manipulate light and sound. “Metamaterials are our answer to the question: How do we make materials that capture the best properties for light and sound, or for heat and motion?” Taylor said. “It’s a technique that has

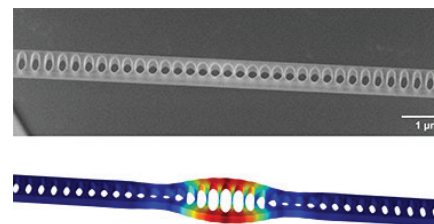

FIGURE 1. Top is an electron micrograph of a silicon nitride beam. The bottom shows how the beam deforms as it vibrates. Credit: Purdy et al., NIST/JQI.

been widely used in engineering, but combining the light and sound together remains still a bit open on how far we can go with it, and this provides a new tool for exploring that space.” ❖

REFERENCES

1. B. Stein, “Quantum Thermometer or Optical Refrigerator?” *NIST News*, <https://www.nist.gov/news-events/news/2017/06/quantum-thermometer-or-optical-refrigerator>
2. X. Xu, T. Purdy, and J.M. Taylor. Cooling a harmonic oscillator by optomechanical modification of its bath. *Physical Review Letters*. Published May 31, 2017. DOI: <https://doi.org/10.1103/PhysRevLett.118.223602>
3. T.P. Purdy, K.E. Grutter, K. Srinivasan and J.M. Taylor, Quantum correlations from a room temperature optomechanical cavity. *Science*. Published June 23, 2017. DOI: <http://science.sciencemag.org/cgi/doi/10.1126/science.aag1407>

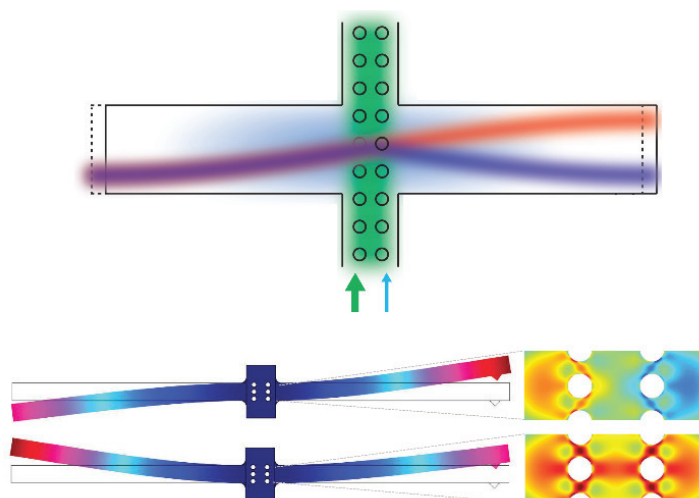

FIGURE 2. Schematic (top) and simulation (bottom) of an optomechanical atomic force microscope (AFM) that takes advantage of optical cooling. Credit: Xu et al./NIST and University of Maryland.

Simulation Apps Advance Tribology Research

Researchers at the Gear Research Centre (FZG), Technical University of Munich (TUM), Germany, packaged their multiphysics model into an app for the simulation of thermal elastohydrodynamically lubricated (TEHL) gear contacts. Their story is a lesson in tackling complex, coupled multiphysics problems that combine structural mechanics and heat transfer with computational fluid dynamics.

by **VALERIO MARRA**

A good example of how complex 21st century engineering simulation problems are is elastohydrodynamic lubrication (EHL). EHL describes the coupling between the deformations of two mating surfaces, such as in bearings and gears, and the hydrodynamics leading to the separation of both surfaces. If thermal effects are considered, the problem is referred to as thermal EHL (TEHL). The lubricant film thickness is usually in the order of microns or below, but sufficient to provide low friction and wear. Detailed understanding of the mechanisms of TEHL helps to improve the power density, efficiency, and noise-vibration-harshness (NVH) behavior of drive systems.

The key is the design of the lubricated contacts of machine elements to treat the lubricant itself as a machine element. TEHL simulation contributes to a

thorough understanding of the lubricated contacts and reduces the number of prototypes. Multiphysics modeling and computer simulation of TEHL contacts is the best way to get to the heart of such a problem (Figure 1).

⇒ TOO SMALL TO MEASURE

With lubricant films and deformations of the solid bodies measuring in microns, any attempt to learn more about TEHL by placing a sensor in the contact region is extremely difficult. “The lubricant film thickness between two gear flanks is in the range of a micron, which equals approximately one-tenth of the diameter of a human hair. Typical contact pressures of up to 2 GPa correlate to about 30 passenger cars on the size of a thumbnail,” explained Thomas Lohner, department leader of EHL-

Tribological-Contact and Efficiency at the Gear Research Centre (FZG), Technical University of Munich (TUM), Germany.

Using numerical simulation, engineers can design TEHL contacts in order to derive appropriate combinations of gear surfaces and lubricant. The difficulty is that TEHL simulation is a

“Coupling different physics and equations is what COMSOL is all about and served us well.”

— THOMAS LOHNER,
DEPARTMENT LEADER AT EHL-
TRIBOLOGICAL-CONTACT AND
EFFICIENCY

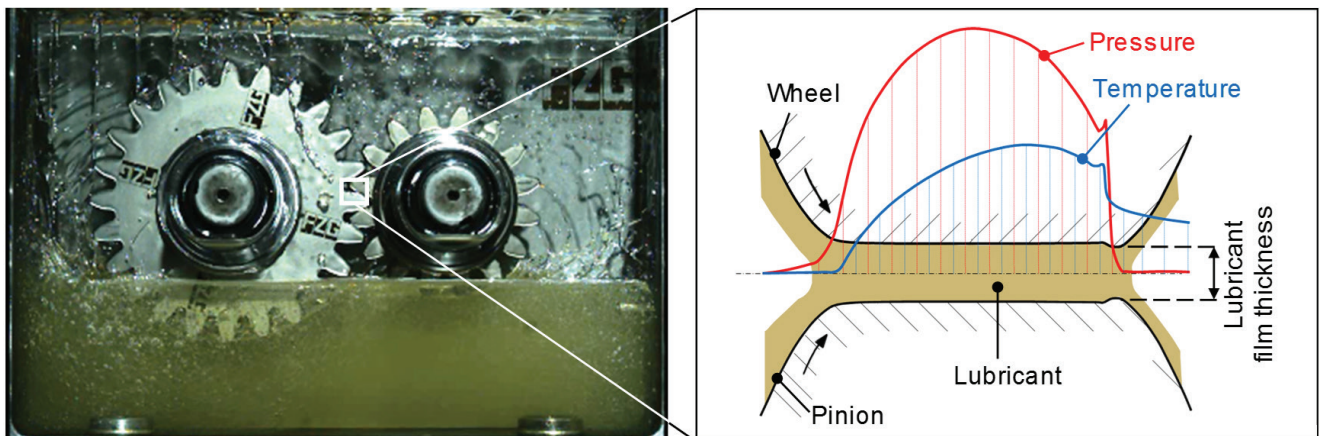

FIGURE 1. High-speed camera image of a dip-lubricated gear pair under operation (left) and schematic illustration of the EHL contact (right).

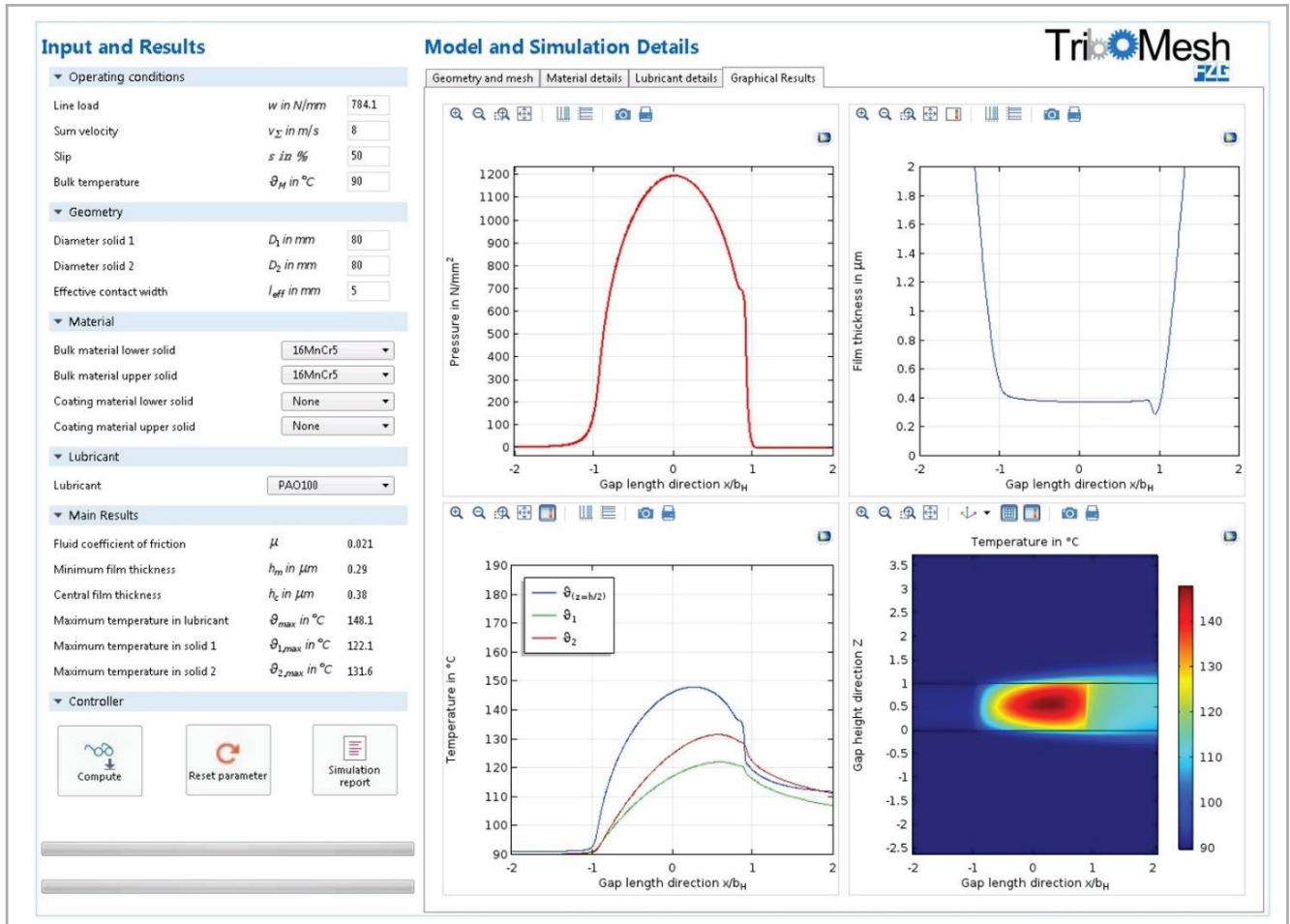

FIGURE 2. This custom simulation app packages a complex, coupled physics solution to TEHL into an easily accessible tool for everybody in the research center to use.

coupled or multiphysics problem. The lubricant is a fluid, so the model requires computational fluid dynamics (CFD), for which the modified Reynolds equation, a reduced form of the Navier-Stokes equations, is frequently used. Lubricant properties such as viscosity depend strongly on pressure and temperature variations. Furthermore, the flow behavior of the lubricant becomes nonlinear for high shear rates. Contact heat is created by shear and compression within the thin lubricant film and distributed by convection and conduction. Temperature changes affect lubricant properties, which influence the hydrodynamics and as a result the elastic deformation, which in turn affects heat generation. Each quantity affects the other, which results in a highly nonlinear iterative loop, including the

elastic deformation of the gear surfaces informed by a coupled structural mechanics analysis.

⇒ FROM PAPER TO MODEL TO APP

Lohner and his team built an application based on a solution method published by a colleague, Prof. Wassim Habchi from the Lebanese American University, Byblos, Lebanon [1]. However, a publication is not a working code that can predict answers. “We implemented the solution using the COMSOL Multiphysics software, which we found convenient to use,” explained Lohner. “It allowed us to modify the Reynolds equation as needed and couple it with other physics to create our TEHL mathematical model,” he said. “Coupling different physics and equations is what COMSOL is all about and served us well.”

The main advantage of using the software is the ability to choose the physics, add customized equations, and then couple everything together to create a working solution [2] without the need to know the details of the numerical solution techniques available, concentrating instead on the modeling aspects. “We are a research center focusing on the design and optimization of machine elements, particularly gears” he explained. “The interface and multiphysics approach behind COMSOL allowed us to focus on the engineering problems rather than the numerical algorithms behind the solution. Furthermore, we benefit from the continuous developments and updates of the software.” For the pressure and film thickness calculation, the researchers used the Weak Form Boundary PDE interface to input the generalized

Reynolds equations [1]. For temperature calculation, the researchers used mainly predefined interfaces available in the software [2].

Lohner and his team created a simulation app called “TriboMesh” (Figure 2) that made their work even simpler to use and distribute it within the research center. To this aim, they used the Application Builder tool available in the software. Apps allows their colleagues to use simulation in practical ways to search for new solutions.

The simulation app has already been deployed to selected colleagues on local workstations. In the future, the app will also be available to colleagues and project partners through the COMSOL Server™ product, which allows users to run apps via a web browser.

One use of the app is for understanding how a diamond-like carbon (DLC) coating improves the efficiency performance of gears. “We conducted test rig experiments that showed that the coefficient of friction is much lower for DLC-coated gears compared to uncoated gears,” Lohner explained. But why? The coating was on the surface, so how could it affect the lubricant? Exercising their app with all of the physics inputs from a test rig showed that the DLC coating trapped heat in the TEHL contact, lowering the viscosity of the lubricant and decreasing friction (Figure 3) [3]. “The DLC coating provides thermal insulation, and we

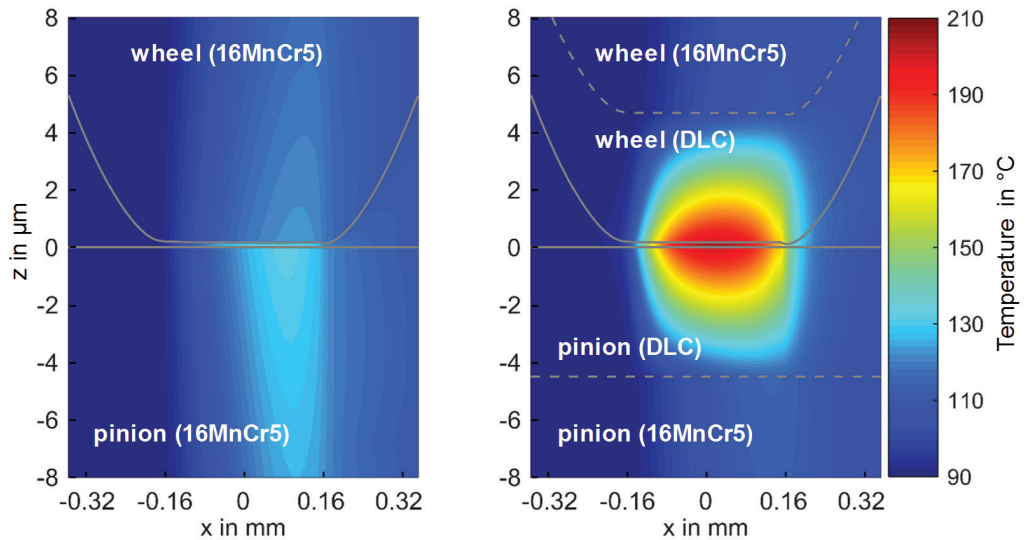

FIGURE 3. TEHL simulation results: temperature distribution of an uncoated (left) and DLC-coated gear pair (right).

could not have proved our hypotheses well without the simulation. We gained a detailed understanding of heat flows in the system and the resulting lubricant behavior,” Lohner said.

⇒ ADVICE FOR OTHERS: START SMALL AND BUILD

For those using multiphysics simulation and apps, Lohner and his team offer sage advice based on their experience. “It is almost impossible for someone who begins to work on very complex systems to begin by doing the whole problem,” he said. “You have to modify your problem to make it as easy as possible in the first step.” In his example, their first cut at the problem modified the Reynolds equation to couple it with simple elasticity equations, ignoring thermal effects. “We then moved on to adding in more complex effects, step by step,” he said. “You have access to all of the complexity you need in COMSOL, so it is easy to program it into

your solution as needed.” He cautioned not to be lulled into thinking accessibility is the same as solving the entire problem well. “You really need to go step by step in a methodical way because the problem is very complex. You must make sure that every step is verified before moving onto the next step,” he said. ❖

REFERENCES

1. W. Habchi, *A full-system finite element approach to elastohydrodynamic lubrication problems: application to ultra-low-viscosity fluids [Dissertation]*, Institut National des Sciences Appliquées de Lyon, Lyon, France, 2008.
2. Thomas Lohner, Andreas Ziegler, Johann-Paul Stemplinger, and Karsten Stahl, *Engineering software solution for thermal elastohydrodynamic lubrication using multiphysics software*, *Advances in Tribology, Volume 2016 (2016)*, Article ID 6507203.
3. Andreas Ziegler, Thomas Lohner, Karsten Stahl, *TEHL simulation on the influence of lubricants on the frictional losses of DLC coated gears, lubricants, Volume 6 (2018)*, doi:10.3390/lubricants6010017.



Members of the research group EHL-Tribological-Contact and Efficiency from the Gear Research Center (FZG) at the Technical University of Munich (TUM), Germany: (left to right) Andreas Ziegler, research associate; Enzo Maier, research associate; Thomas Lohner, department leader; and Karsten Stahl, full professor and director of FZG.

Create
THE
Future

DESIGN CONTEST 2018

15th Anniversary

HOW WILL YOUR DESIGNS CHANGE THE FUTURE?



The world's greatest inventions started with an innovator sharing their idea with the world. **Now it's your turn.**

CALL FOR ENTRIES

WIN \$20,000 & GLOBAL RECOGNITION

Now accepting entries!

For Complete Details VISIT:
CreateTheFutureContest.com

JOIN THE CONVERSATION: #CTF2018   

PRINCIPAL
SPONSORS



IMPROVING EFFICIENCY IN IRON ORE SINTERING

Process engineers are using multiphysics simulation to pave the way for the mass production of steel to be faster, more economical, and environmentally friendly.

by **ZACK CONRAD**

At the heart of manufacturing is a perpetual effort to simultaneously improve both efficiency and quality, and the steel industry is a prime example of this. As steel production entails a lengthy chain of processes, there is ample opportunity for advancements to be made. The VDEh-Betriebsforschungsinstitut (BFI), one of Europe's leading research institutions in the development of iron and steel making technology, is currently using multiphysics simulation to optimize their configurations and achieve these improvements.

⇒ PREPARING THE SINTER FOR THE BLAST FURNACE

A significant step in the steel production line is the sintering process, where a mix of fine iron ore and other materials is prepared for a blast furnace to melt out its base metal, eventually allowing for production of the steel's final form. Sintering involves using high temperatures to bake a powdered mix until it fuses together, creating a porous mass, which is then placed in the blast furnace. As shown in Figure 1, the initial mix, consisting of iron ore fines, coke (fuel), and flux (lime stone), is fed into the plant and ignited, while air is sucked from below the mix to accelerate the coke combustion downward and boost partial ore melting & solidification, calcination, and drying.

Increases in efficiency, especially in manufacturing, often manifest themselves via decreases in completion time. "If we can speed up the process and reduce the time it takes to complete, the efficiency will increase," explains Dr. Yalcin Kaymak, a researcher at BFI. "A higher efficiency will then increase our productivity, conserve energy, and even reduce emissions." In sintering processes, a decrease in completion time is achieved by speeding up the combustion of the mix. The overall efficiency also depends on factors such as the permeability and porosity of the mix, flow rates, temperature field, and overall sinter strength. Dr. Kaymak, Dr. Hauck (BFI), and Dr. Hillers (Shuangliang Clyde Bergemann) study the effects of all of these factors in their numerical simulations.

A possible solution that BFI explored is the aeration of the raw mix during feeding using horizontal and/or vertical permeability bars (Figure 2). As the conveyor belt moves, horizontal permeability bars create a horizontal, oval-shaped locally aerated region. The vertical permeability bars cut the packed bed to create a roughly rectangular aeration region. In this case, the affected region is a vertical plane following

will yield the most substantial increase in porosity.

⇒ MULTIPHYSICS MODELING OF THE SINTERING PROCESS

The mathematical model needed to simulate a combustion process in iron ore sintering is truly multiphysics, consisting of numerous subprocesses that involve heat transfer, chemical reactions like melting and solidification, and porous media flow. To effectively integrate these physics, multiphysics simulation is used. "COMSOL Multiphysics is fast and offers a lot of flexibility," says Dr. Kaymak. "You can edit expressions and control the mesh according to your needs." Full advantage is taken of the flexibility to input custom expressions by manually implementing independently developed porosity distributions into the model, a crucial step

the vertical bar axis. The permeability bars increase the porosity of the bed, thus improving the air supply to the fuel, speeding up combustion and increasing the efficiency. The focus of the simulation was to determine the optimal configuration of the bars that

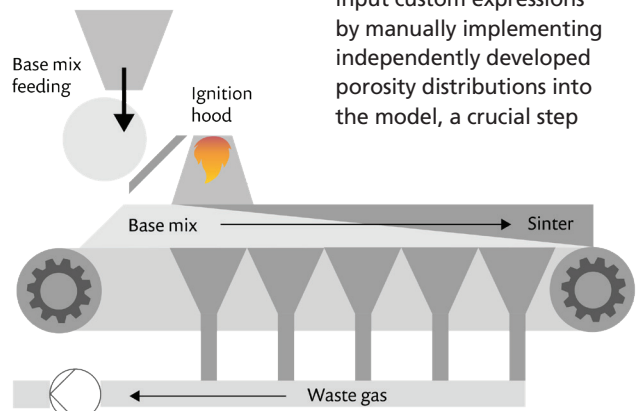

FIGURE 1. Sintering process scheme.

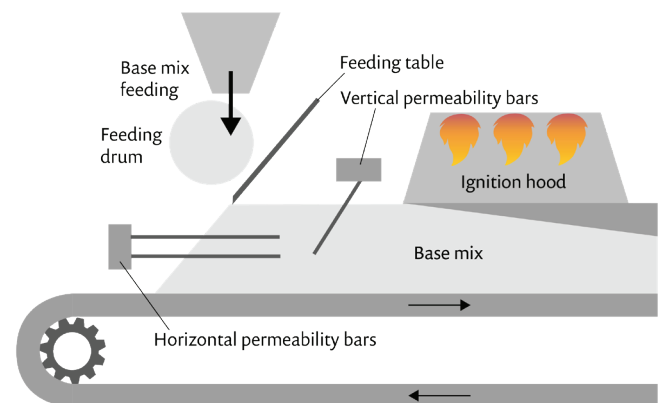

FIGURE 2. Sintering process schematic with permeability bars added.

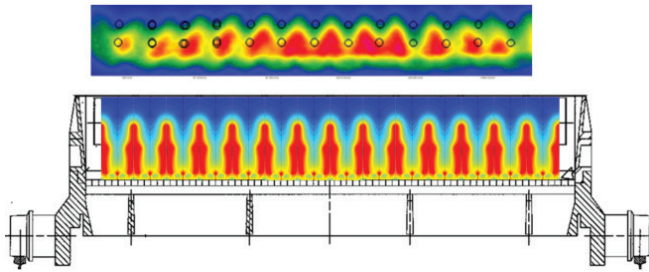

FIGURE 3. Measured (top) and simulated (bottom) high temperature zone at discharge.

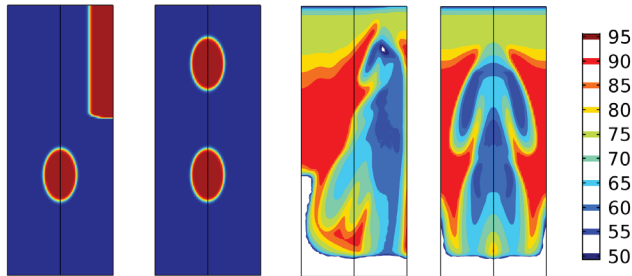

FIGURE 4. Quality estimations for two permeability bar configurations.

in characterizing the local permeability of the base mix. To determine these distributions, experimental air velocity measurements of specific configurations are used. By allowing air to flow through the mix, the resulting air velocities can be measured and the porosity distribution can then be defined and input directly into the software.

After meticulously studying the porosity distribution and implementing it into the overall model, a transient sinter process can subsequently be simulated, yielding a temperature profile definition and a thorough investigation into various configurations. Additionally, the global ordinary differential equations feature for time integral operation is used to compute numerous relevant quantities, yielding a comprehensive characterization of the configurations’ effects on the process. These quantities include the total energy inlet and outlet, moisture content, total inlet substances, total energy inlet at the ignition hood, total outlet substances, and total gas volume.

Because combustion is such a significant part of the sintering process, the temperature profile of a certain configuration has a direct impact on completion time and sinter strength. The cold strength is a key indicator when assessing sinter quality, since high strength for sinter means that it can withstand harsh conditions in the blast furnace process. The sinter strength is measured by tumble tests and usually raises with the time spent above the melting start temperature. Thus, the information about the local time-dependent temperature profiles can be used to estimate the local cold strength. This results in a quality distribution through the cross section, as shown at the top of Figure 3.

To validate the simulation results, temperature profiles were compared with plant discharges observed with infrared thermography and proved to be strongly substantiated. The small circles in the measured thermography in Figure 4 show

the position of horizontal permeability bars. It can be easily recognized that the permeability bar locations coincide with low temperature regions. The same trend is also computed in the simulation models.

⇒ **RESULTS AND FUTURE WORK**

The simulations demonstrated that with the optimal configuration of permeability bars, the sintering speed can be raised by up to 40%. Said optimal configurations consist of either two stacked rows of horizontal bars or vertical bars with horizontal bars in between. The configuration with two rows of horizontal bars can be seen in Figure 5. Now, as BFI seeks to add further complexity and broaden the scope of this model, the next step is to ensure quality and strength is maintained during the sintering process.

To generate additional accuracy and capabilities, plans are in the works to expand the model to encompass phenomena such as diffusion and dispersion in the convection equations and NOx emissions. It is also planned to use the Application Builder tool to create and implement user-friendly simulation apps to aid

the plant operators. Experts can customize the interface and control the inputs and outputs that the app displays, empowering individuals without a simulation background to focus solely on relevant parameters

“COMSOL Multiphysics is fast and offers a lot of flexibility!”

— YALCIN KAYMAK, RESEARCHER AT BFI

when running the apps. These apps can subsequently be deployed with COMSOL Server™ product to people throughout the organization, spreading the power of multiphysics modeling. Of particular interest to them are the specific energy flow, bed temperature, exhaust gas temperature, coke consumption, calcination, sulfation, condensation, and sinter quality. “Operators do not have the simulation experience or know the details of the software,” explains Dr. Kaymak. “But with a user-friendly app, they can be creative with the parameters that are more important specifically to them, model quick changes, and see the effects right away.” ❖



FIGURE 5. Sinter plant feeding system in operation with two rows of horizontal permeability bars.

The Sound of Perfection Thanks to the Modeling of Acoustic Metasurfaces

Acoustic metasurfaces are carefully engineered to control, direct, and manipulate sound waves in order to produce a specific acoustic property (e.g., a negative refractive index) that is not readily available in nature. A research team from the École Polytechnique Fédérale de Lausanne (EPFL) in Switzerland has simulated a novel "active" acoustic metasurface that could be used for enhancing the acoustics of concert halls and soundproof homes or damping irritating engine sounds during a flight.

by **GEMMA CHURCH**

A fundamental constraint of conventional acoustic treatments is that their dimensions limit their use frequency-wise (the thinner, the lesser the performance toward low frequencies), or that they rely on resonances to enhance their acoustic effect and are therefore restricted to a very narrow frequency band. For example, a membrane absorber (bass trap) placed in the corner of a recording studio to absorb low-frequency sounds that build up and interfere with the quality of the audio being produced only affects a limited frequency range around its resonance. However, these nuisance low frequencies usually span the 20 to 200 Hz range and a single acoustic treatment cannot absorb over this range of frequencies.

⇒ DIRECTING WAVEFRONT TRAFFIC

It is not practical to implement a design providing sound absorption at low frequencies, as the resulting structure would be too bulky and too difficult to optimize. Hervé Lissek, head of the acoustics group at the EPFL (École Polytechnique Fédérale de Lausanne), said: "Traditional membrane resonator capabilities are restricted to a range of just a few hertz, a limitation that precludes their mainstream application. Our idea was to develop a design that

was broadband and active in nature." This led to the development of the Active Electroacoustic Resonator (AER) concept, where a conventional loudspeaker is used as a membrane absorber; the acoustic behavior of which can be modified by electric means (Figure 1).

With the knowledge gained from examining AERs, Lissek and his team tackled the concept of acoustic metasurfaces. An acoustic metasurface is basically a surface composed of small acoustic elements (membranes, small perforations, cavities, etc.), which are engineered to provide, as a whole, novel acoustic properties that each individual element does not provide by itself. In the metasurface concept, the assembly confers the acoustic properties down to wavelengths that are much longer than the size of each element (these unit cells are thus qualified as "subwavelength"). The metasurface can then either be engineered to provide sound absorption or direct wavefronts reflected over the metasurface toward a prescribed angle.

⇒ ACTIVE ADAPTION COULD BRING A RAINBOW OF SOUND

In order to model an acoustic metasurface, you must break that surface down into subwavelength unit cells to artificially reshape the acoustic wavefront and produce the desired result. The active



FIGURE 1. Active Electroacoustic Resonator prototype. Image credit: EPFL/Alain Herzog.

acoustic metasurface proposed by Lissek and his team consists of a surface array of subwavelength loudspeaker diaphragms, each with programmable individual active acoustic impedances allowing for local control over the different reflection phases over the metasurface.

An active control framework is used to control the reflection phase over the metasurface. This is derived from the AER concept, where AERs can be tuned or modified through electroacoustic control schemes (Figure 3). Lissek explained: "We can change the way this metasurface reacts to a sound profile by electrically tweaking the membranes. Furthermore, this allows the membranes to actively adapt to the incoming sound. For example, if you are trying to mask the engine noise of an aircraft, the active nature of the active acoustic metasurface means it will change as the frequency of the engine changes during the different phases of flight, which could be in the range of some hundreds up to a few thousands of hertz." In an AER, the controller is known to achieve a wide variety of acoustic impedances on a single loudspeaker diaphragm used as an acoustic resonator, with the possibility to shift its resonance frequency by more than one octave.

You could even take this concept to reflect sound waves in a prescribed manner. Lissek added: "If broadband

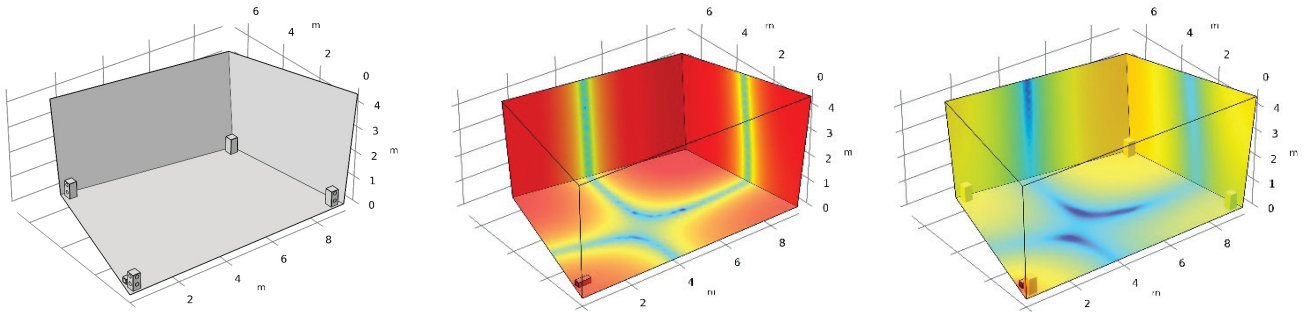

FIGURE 2. Left: Geometry of the reverberant chamber with four AER prototypes at the 4 corners. Middle and right: Sound pressure level distribution in the chamber excited on mode 110 at 35.3 Hz without and with absorbers, respectively.

noise (the acoustic counterpart of white light) is incident on an acoustic metasurface, then the acoustic metasurface could split noise, acting as an acoustic prism where you direct each constitutive frequency toward different directions. From an artistic perspective, there are many fascinating implications, as you would unleash a rainbow of sound, but the most forthcoming applications are primarily in noise reduction.”

⇒ NUMERICAL SIMULATION INFORMS ACOUSTIC DESIGN

There are many complex phenomena that must be taken into account when simulating an acoustic metasurface and the surrounding acoustic environment. Lissek says “COMSOL Multiphysics gives us the ability to assess the sound performance of the devices that we design. What’s more, it gives us a precise insight into the physics of the

“COMSOL Multiphysics gives us the ability to assess the sound performance of the devices that we design. What’s more, it gives us a precise insight into the physics of phenomena and devices that we may not be able to experimentally assess.”

— HERVÉ LISSEK, HEAD OF THE ACOUSTIC GROUP AT THE EPFL

devices that we may not be able to experimentally assess.”

Let’s go back to our previous example of a recording studio and extend it so we now have four small active absorbers (Figure 2) sitting in the corner of a room to absorb low-frequency sounds. To simulate how these devices will absorb and affect the sound within the room, you need to know the sound pressure in the room at different points. Lissek explained: “With multiphysics simulation, we can instantly get the frequency distribution in the room with and without the presence of the active absorbers. We can then model the distribution of the sound in the room to learn important parameters such as the modal decay time for the sound to dissipate in the room at its resonance frequencies.”

“We can do this all in just ten seconds using the software. We do not need to have acoustic measurements at every point in the space. We can easily map the sound pressure distribution as we move the absorbers to different positions around the room and extrapolate how this changes the sound pressure distribution,” Lissek added.

⇒ FINDING THE RIGHT DIRECTIVITY WITH THE RIGHT METASURFACE DESIGN

Many different types of acoustic metasurfaces have been proposed and simulated by Lissek and his team. These include spiral acoustic unit cells, Helmholtz resonators, and active acoustic metasurfaces.

The reflection properties were first set to define individual control laws to assign to each AER unit cell. The identified control settings were then applied to an AER unit cell based on a

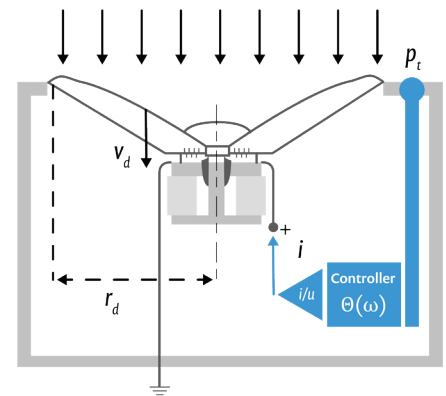

FIGURE 3. Illustration depicting the Active Electroacoustic Resonators (AER) concept.

commercially available “off-the-shelf” electrodynamic loudspeaker in order to experimentally assess the feasibility of the targeted reflection phases along a metasurface of 32 elements (Figure 4). Once the target reflection coefficients were verified, the metasurface was numerically modeled where a full-wave simulation was performed. “The individual elements move like pistons. They are not governed by complex structural dynamics, so we simply assigned the achievable acoustic impedance of each membrane of the model,” Lissek explained.

Two cases were simulated with a plane wave background pressure with an incident angle of -45° . The desired angle for the wave reflected over the metasurface was set to 60° and 0° , breaking the Snell-Descartes’s law of reflection. The simulation results in Figures 5 and 6 represent the reflected sound pressure level maps over the xz-plane for the two studied angles at $f =$

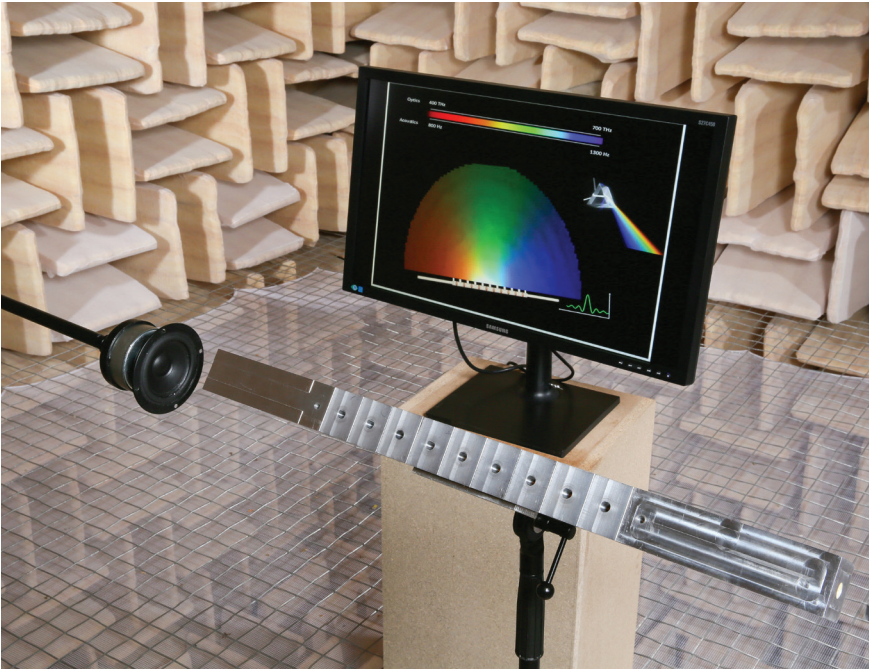

FIGURE 4. Acoustic dispersive prism prototype. Image credit: EPFL/Alain Herzog.

350 Hz. It can be seen that the acoustic impedance imposed on the metasurface unit cells actually allows the wavefronts to be steered toward the prescribed angle.

Figures 5 and 6 demonstrate that there is good agreement between the achieved directivities and the targeted reflected angles, which confirms the effectiveness of the AER to achieve coherent steering over a relatively wide frequency band (almost one octave around 350 Hz). Having shown the

effectiveness of the active acoustic metasurfaces over a greater range of frequencies, the researchers were able to further their design and experimental investigations thanks to simulation. Lissek added: "I don't consider myself an expert in FEM modeling. So, one of the greatest benefits for me of COMSOL Multiphysics, is that it provides a simple and user-friendly, yet powerful, set of tools that are easily accessible."

⇒ FURTHERING METASURFACES RESEARCH

The researchers want to move to a full 3D simulation of the acoustic metasurface. Lissek said: "For the purposes of this preliminary research, we used a simplified 1D model (assuming the metasurface has an infinite size towards the y-axis) allowing for faster computation. But a model accounting for the real 2D metasurface in a full 3D acoustic domain should provide more information on the reflected wave properties (e.g., the truncature of the metasurface over the x- and y-axes should increase the directionality of the reflected wave)." They are also integrating lumped circuit modeling into their work to get better insight into the coupling between the acoustic domain and the electrical quantities used in the active control, such as electrical current flowing into the individual AERs. This could also help them develop advanced control strategies; for example, where all the AERs are electrically interconnected.

To further extend their work, Lissek and his team would like to investigate how to integrate such acoustic metasurfaces into a room design. "For example, imagine the possibilities of a theater or a concert hall fitted with acoustic metasurfaces, where the sound reflections can be spatially controlled to create a consistent sound quality. If we could electrically control sound propagation in a room, that would be the Holy Grail for any acoustic professional," Lissek concluded. ✨

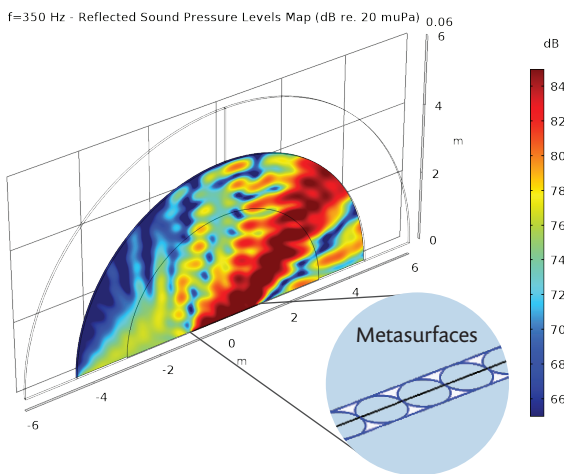

FIGURE 5. Reflected sound pressure levels with 32x32 unit cells at $f = 350$ Hz, for a prescribed reflected angle of 60° .

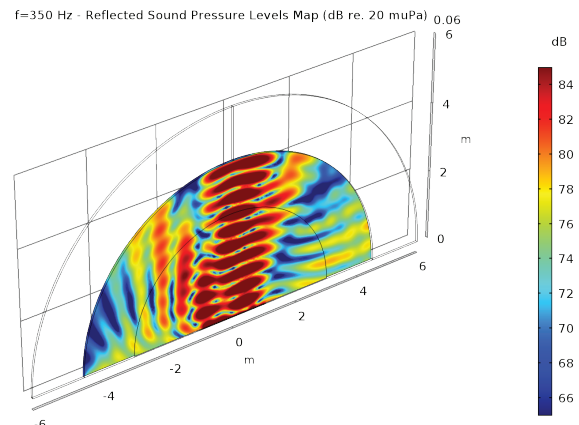

FIGURE 6. Reflected sound pressure levels with 32x32 unit cells, at $f = 350$ Hz, for a prescribed reflected angle of 0° .

OPTIMIZING PASSENGER VEHICLE DESIGN WITH SIMULATION APPS

The team at Mahindra turned to simulation apps to accelerate their product design process and foster a culture of collaboration.

by **ADITI KARANDIKAR**

Product design for modern-day automotive manufacturers is an iterative process that requires collaboration between computer-aided engineering (CAE) analysts, design engineers, the manufacturing team, and the suppliers. As new vehicles are introduced at an accelerated pace, efficient collaboration is needed to streamline the iteration process and maintain a competitive edge in today's consumer landscape. One of the main efforts for a company like Mahindra is to renovate their processes while ensuring the quality, safety, and reliability their customers have come to expect. Instrumental to the team's success are simulation apps used to make the design process more inclusive and robust.

⇒ CHALLENGES DURING PRODUCT DESIGN

Collaboration can be a time-consuming process that requires different teams to consolidate their expertise in a meaningful and efficient manner. Design engineers demand evaluations of new concepts or adjustments to existing designs, which can be hard due to the complexity of the physics involved. CAE analysts, however, have the simulation expertise to manage high levels of complexity. They can provide assistance with concept evaluations through detailed CAE analysis. But with a limited number of analysts and an increasing volume of requests, these evaluations can be difficult to obtain in a timely manner.

The design lead time for a particular vehicle component varies with the number of back-and-forth iterations required

FIGURE 1. A typical stabilizer or antiroll bar.

to finalize it and can take months in some cases. Depending on the design complexity of the proposal submitted, the CAE analysis alone can take weeks or months to complete. Based on the simulation results, the design team makes certain modifications and again awaits validation of the design by the CAE team. These iterations are crucial to the safety and reliability of the vehicle.

To overcome the race against time, the methods team at Mahindra has explored the Application Builder tool available in the COMSOL Multiphysics® software. The team looked at various options for the stabilizer bar and chassis designs via simulation apps. The adoption of apps resulted in substantial reductions in iteration times compared to the conventional approach.

“The adoption of apps resulted in substantial reductions in iteration times compared to the conventional approach.”

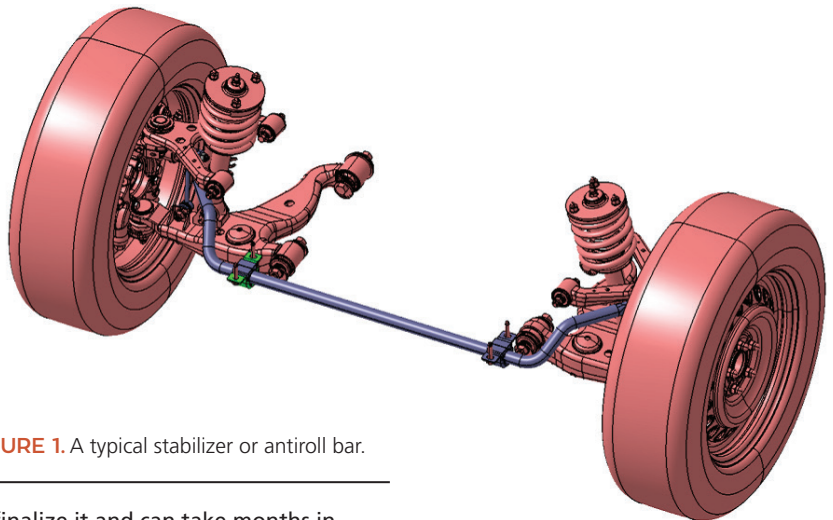

⇒ AN INNOVATIVE APPROACH FOR DESIGNING THE STABILIZER BAR

A critical component of suspension used to limit the roll of a vehicle is the stabilizer bar, shown in Figure 1. The design is typically either a hollow or solid beam with multiple bends. To accurately model the deformations and stresses in such a component, the design team must ensure the appropriate stiffness and stress levels are met, either by collaborating with the CAE analysts or requesting validation from their suppliers. Once the model was validated and the results were in good agreement with the experiments, a simulation app was created.

The simulation app of the stabilizer bar can accommodate a large variety of design configurations with up to fifteen bends and the option of exploring either hollow or solid bars, with an example shown in Figure 2. The end user, typically a member of the design team, enters the coordinates of the bends to represent the geometry of the stabilizer bar and provides bearing location, bushing stiffness, and cross

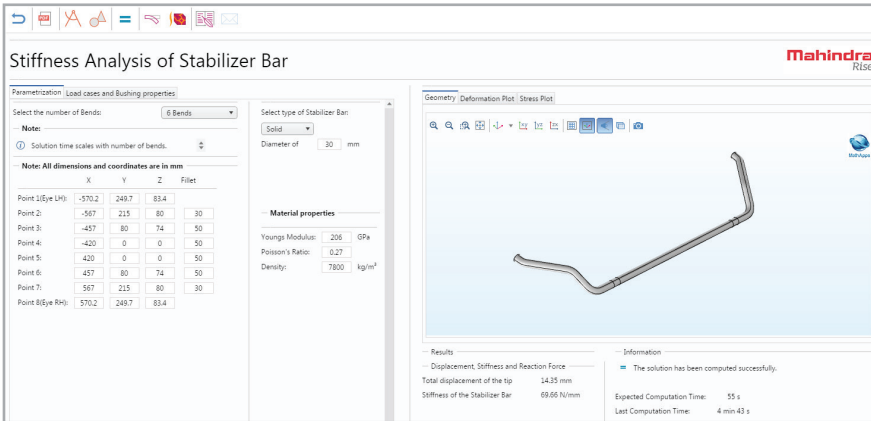

FIGURE 2. Simulation app that lets you create the geometry and calculate the stiffness and displacement of a stabilizer bar.

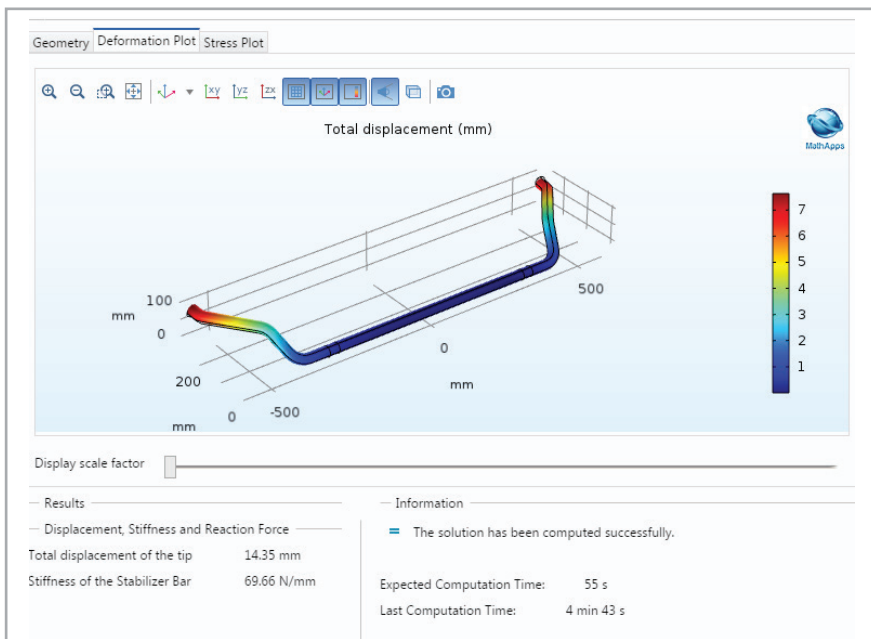

FIGURE 3. The results obtained from an app that calculates the stiffness of a particular configuration of a stabilizer bar.

section parameters. The CAE analyst predefines the constraints within the app, making it simple and quick for the designer to run accurate simulations; compute the stiffness of the bar; and model the stresses for standard load cases, which can be seen in Figure 3. The typical runtime of the application takes minutes, empowering the design team to run successive iterations and get immediate feedback on their designs. Knowing that the simulation app is based on a validated multiphysics model, the design team is confident in the results without requiring additional

training in simulation. The team at Mahindra has found that the apps save significant amounts of time and encourage collaboration. Additionally, the new culture of collaboration has fostered a greater sense of ownership of the end product, as the design can be generated in one or two days, reducing the dependence on the supplier.

⇒ REDUCING THE ITERATIONS IN CHASSIS DESIGN

The chassis is another important load-bearing component that provides stiffness to the vehicle and acts as a base for mounting other components, such as the engine and transmission. One of the common architectures is a ladder frame with two long side members and a number of cross members (Figure 3). The number, size, position, and shape of the cross members are important parameters that are decided early in the design process.

The load carried by the chassis results in combined bending and torsional loads for which no simple analytical solutions are available. The conventional approach to addressing this entails the evaluation of multiple chassis configurations based on the packaging requirements followed by numerous CAE iterations to finalize the design. The right packaging makes sure that all of the parts work together without any interference and with proper access for assembly and disassembly. The best design needs to be structurally sound and satisfy

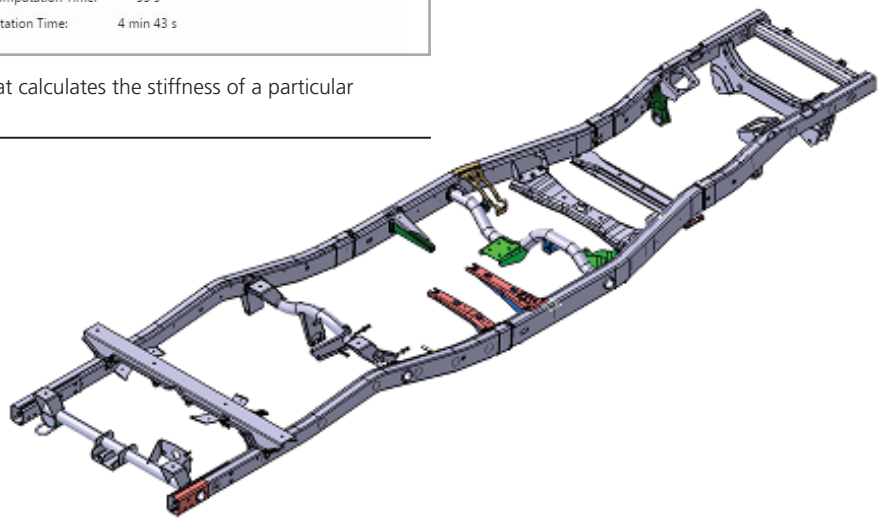

FIGURE 4. Geometry created in CATIA® software representing the structure of a typical utility vehicle chassis.

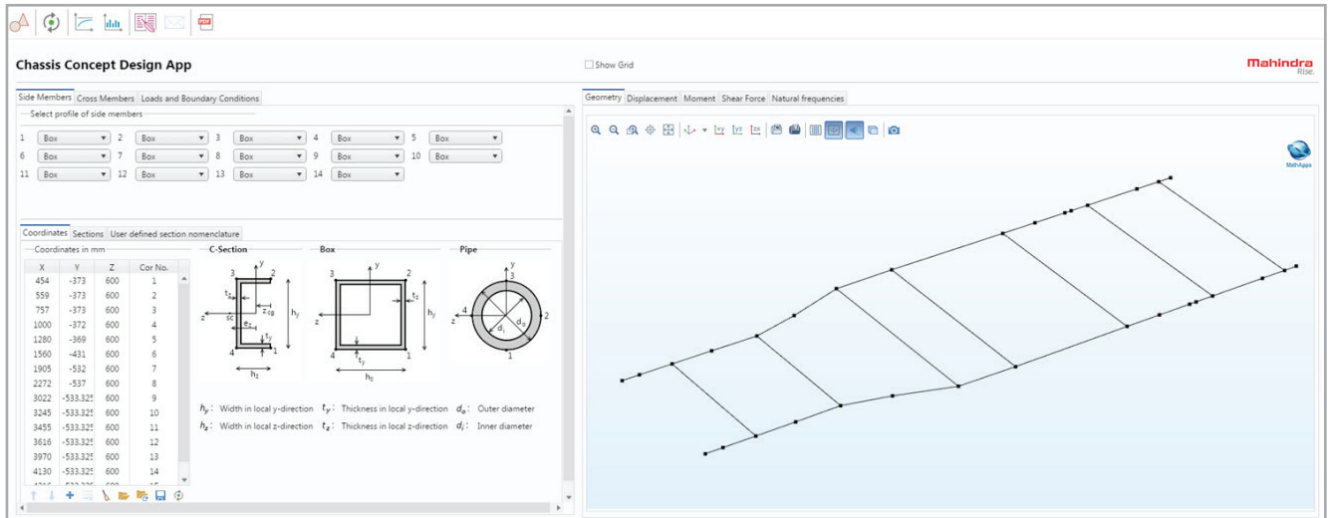

FIGURE 5. The user interface of the chassis simulation app available on Mahindra's internal portal, called MathApps.

packaging requirements at the same time. While taking packaging considerations into account, each full CAE iteration involves three separate analyses: bending stiffness, torsional stiffness, and modal. This approach requires three to four full CAE iterations, each one typically taking two to three weeks.

Using COMSOL Multiphysics, the team was able to combine the three separate analyses, resulting in only one or two full CAE iterations, saving precious time. They then went on to create a simulation app for the chassis design featuring a 1D beam model (Figure 5) based on the Timoshenko beam theory. The end user doesn't need to know the underlying mathematical model to benefit from the results offered by the app. The simulation can be completed in a matter of seconds, even for a complicated chassis design with various cross sections and members. The beam analysis provides fast and reliable results for a wide range of configurations and computes both torsional and bending stiffness and displacement, shown in Figure 6. The simulation app is used by the drive away chassis (DAC) suspension team, responsible for the design of the chassis and the stabilizer bar. The app offers the convenience of evaluating various design parameters through simple text fields rather than creating a CAD model for each configuration, which is a time saver for both the CAE analyst and the DAC suspension team.

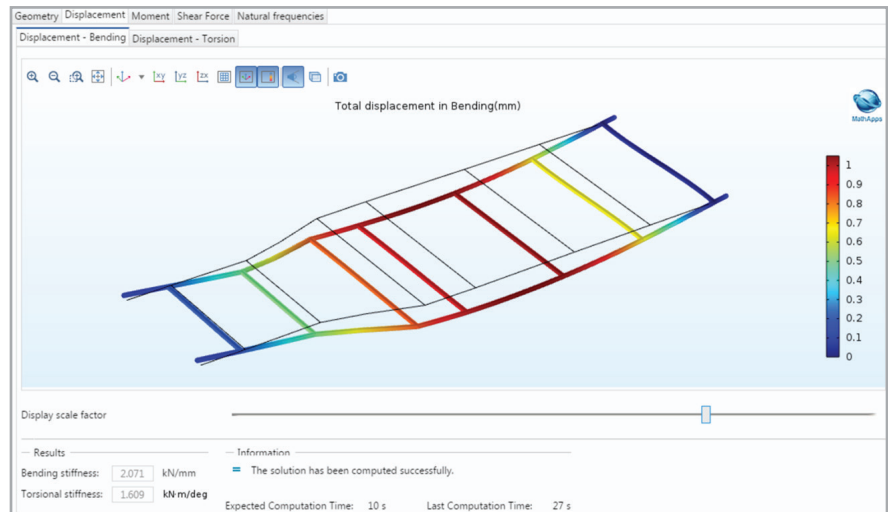

FIGURE 6. Simulation results obtained from the chassis app for a particular configuration.

⇒ SIMULATION APPS AND THE ROAD AHEAD

The uniqueness of the apps used at Mahindra lies in their ability to handle a wide range of parametric variations, physics, and boundary conditions. This enabled the designers to explore various design options early into the product development phase, without the need to rely on the CAE analysts or obtain additional training in numerical modeling. The results of the parametric studies are presented within the design guidelines, enabling efficient and cost-effective products.

The simulation apps were developed based on detailed discussions with designers and CAE analysts before being deployed across various teams at Mahindra via a local installation of the COMSOL Server™ product. Complex design configurations that were previously under the guard of the CAE analysts became accessible to the designers in a convenient and easy-to-use platform. Multiphysics simulation and apps enabled Mahindra to expand their analysis capabilities to also include vibro-acoustics and thermo-structural analyses in their future simulation work. ❖

MULTIPHYSICS PROTECTS WIND TURBINES WHEN LIGHTNING STRIKES

Multiphysics simulations help NTS engineers understand what happens when lightning strikes a wind turbine.

by **GARY DAGASTINE**

As the world moves to reduce its dependence on fossil fuels, the global market for wind turbines is growing, projected to reach around \$70 billion dollars annually in the next few years. While wind power on such a scale is a great achievement, another powerful force of nature is preventing the industry from reaching its full potential: lightning.

Lightning strikes are the single largest cause of unplanned downtime in wind turbines, responsible not only for the loss of untold megawatts of power but also for huge operation and maintenance costs.

Wind turbines are particularly susceptible to lightning strikes because of their great heights, exposed locations, and large rotating blades. Lightning can wreak havoc, both directly and

indirectly, on virtually all wind turbine components, including blades, control systems, and other electrical components. Repair is not only expensive but also physically challenging given the logistical constraints.



FIGURE 1. High-voltage generator (2.4 MV Marx generator) operated by NTS.

Lightning Technologies, an NTS company, is a world leader in the design and validation of sophisticated lightning protection systems for the aerospace industry, including aircraft, space vehicles, and launch facilities. They also developed systems for wind turbine farms, industrial complexes, golf courses, theme parks, and other high-risk locations.

Engineers at NTS are actively involved in the committees that form the International Electrotechnical Commission (IEC), which define the lightning levels and situations that blades must endure. Industry regulations such as IEC 62305 require wind turbine manufacturers to incorporate lightning protection designs into their blades. For maximum protection, it's essential to know how much lightning current is likely to flow through a blade following a lightning strike and precisely where it will flow. The problem is that simple assumptions about the behavior of lightning current often lead to inaccurate conclusions.

⇒ DEEP INSIGHTS INTO LIGHTNING CURRENT

NTS operates one of the most complete lightning simulation laboratories in the world from an 18,000 ft² facility in Pittsfield, MA, USA, featuring 14- and 25-foot tall lightning generators capable of generating as much as 2.4 MV (Figure 1).

NTS has been involved in the research and development of protection designs for wind turbine blades for decades. Because wind turbine blades are airfoils, the company's deep knowledge base of aerospace applications is directly transferrable.

Justin McKennon, who leads the Modeling and Analytical Team at NTS Pittsfield, said that traditional wind turbine protection schemes consist of a surface protection layer (SPL) covering the lightweight, high-strength carbon fiber composite blades. Often, the SPL consists of a conductive mesh meant to safely carry lightning current from the point where it "attached to"

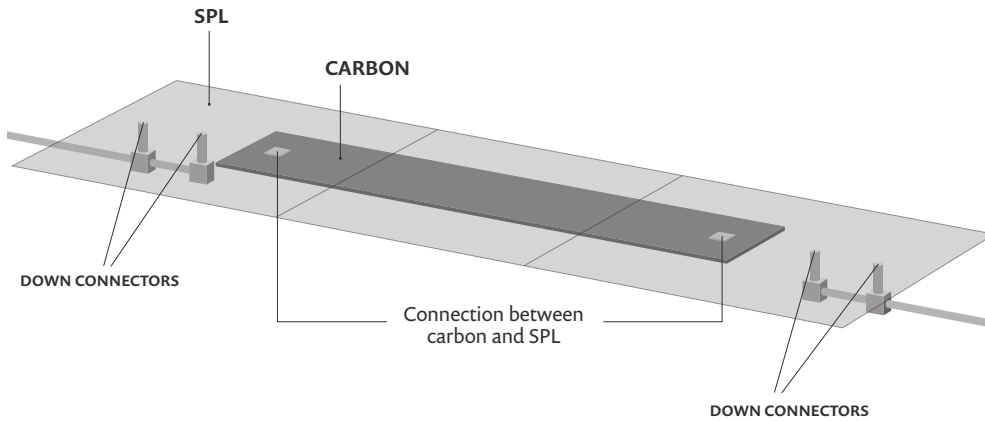

FIGURE 2. Geometry of the thin aluminum surface layer protection (SPL) placed on top of a carbon stack.

(e.g., hit) the blade and then from the root to the ground. “Many blade architectures feature stacked carbon fiber structural layers running parallel to the SPL, with periodic electrical connections between the stack and the SPL all along the blade’s length,” McKennon explains. “This is done to prevent a high voltage potential from developing between the two, because if that should happen, arcing could occur and damage the blade. However, while these electrical connections can reduce voltage, they also allow current to flow in the carbon, which creates additional design considerations.”

Understanding a carbon stack’s ability to carry various amounts of current, along with other factors such as likely attachment points and puncture possibilities, isn’t trivial. McKennon said that given the cost to physically test these blades, some of which are 70 or more meters long, the numerical modeling of lightning effects has become a crucial part of the design process.

“Because of the complexity of the physics involved, though, it’s easy to make improper assumptions that can have a large effect on the accuracy of the models,” McKennon says.

⇒ **SIMULATION REDUCES OVERENGINEERING**

“Our ability to rapidly simulate and turn around models greatly reduces program risk, and allows for engineering level data to be obtained almost in an on-demand fashion.”

One common but improper assumption is to assume that the carbon stack’s conductivity is the same in all directions, even though in reality there could be significant differences in carbon’s conductivity along different directions. Figure 2 shows the geometry of a carbon stack placed 5 mm

below a 500- μ m-thick SPL mesh made from an aluminum sheet, whose conductivity is set according to experimental measurements. The carbon’s conductivity is also set according to experimental values, both its idealized isotropic and realistic

anisotropic behavior have been considered in the COMSOL model. An analytical representation of an IEC-standard current waveform is used to inject

current into one end of the SPL. The current exits at the opposite end through a down conductor, which is made of copper, as are all of the connections to the carbon.

To investigate his designs and model the propagation of electromagnetic pulses, McKennon solved a time-domain wave equation for the magnetic vector potential in the COMSOL Multiphysics® software. The results enabled him to determine the associated currents, electric fields, and other values at those points, providing insight into the current’s overall behavior throughout the entire structure.

The isotropic case underestimates the amount of current traveling through

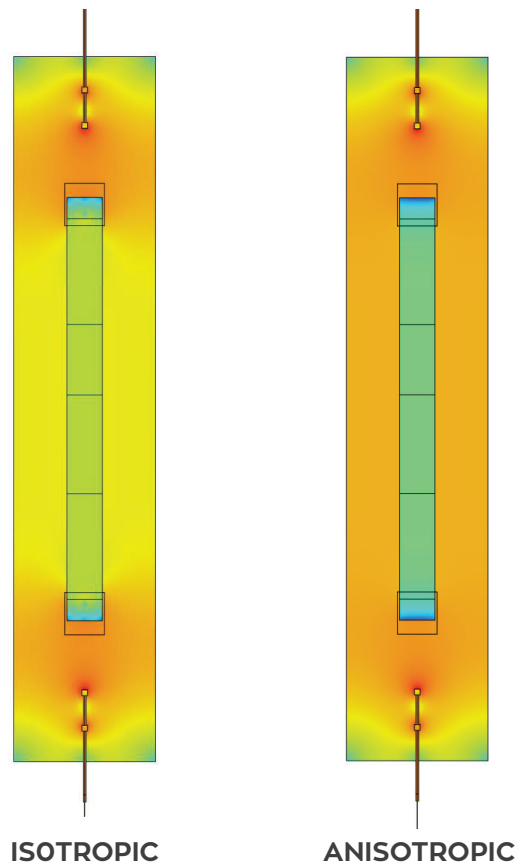

FIGURE 3. Simulation results showing that the amount of current in the SPL in the idealized isotropic case is significantly less than the realistic anisotropic case.

the SPL, implying that more current is traveling in the carbon and not in the SPL (Figure 3). Carbon is made up of many layers of individual fibers. It is very conductive in the fiber direction, but getting current into and out of the carbon is very challenging. If too much current has to pass through an interface between the carbon and something else, many of the individual fibers in the carbon can be burned away through heating and/or arcing (Figure 4). Carbon bears the primary structural loads, and damage here greatly reduces the lifetime of the blade and, in some cases, can lead to catastrophic loss of the blade. More current in the carbon is something engineers want to seriously avoid.

The isotropic case grossly overestimates the amount of current in the carbon because it ignores the very real orientation-dependent resistances in the carbon (Figure 5). Thus, given its large volume and comparable length, the carbon seems to be a more preferred current path than the SPL, even though it isn't in reality. Such an overestimate would introduce additional challenges that are not present, thus slowing down the development process and leading to an overengineered product.

McKennon says, "In modeling such complex physics, you really have to know what's important and what's just noise, and you must build your model carefully in a step-by-step fashion so that no errors or false assumptions are introduced that can significantly affect your results."

⇒ RELIABLE RESULTS FOR BUSINESS DECISIONS

"Our ability to rapidly simulate and turn around models greatly reduces program risk and allows for engineering level data to be obtained almost in an on-demand fashion," says McKennon. "Rather than spending considerable amounts of time and money fabricating complex test articles, we can use COMSOL to simulate the physical phenomena and drastically reduce the problem scope for these projects. In many cases, critical data simply cannot be measured on real test articles, which requires simulation and analysis to fill in these holes."

"Time is money in our industry, and our customers are very pleased with the service we're able to provide thanks to these capabilities. In fact, some customers are so confident in the validity of our simulations that they've begun to make wholesale business decisions based solely on our results, with little experimental verification. With that much at stake we simply can't afford to make mistakes, and COMSOL is a valuable tool that we trust to deliver real-world accuracy." ❖

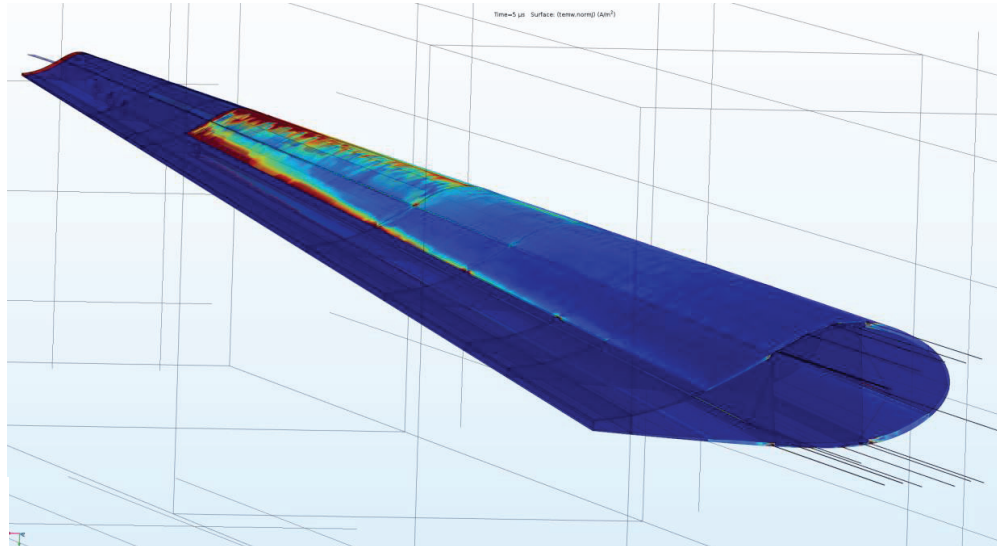

FIGURE 4. Simulation results showing the current density on a sample wind turbine blade made of several carbon stacks.

Current flowing through carbon

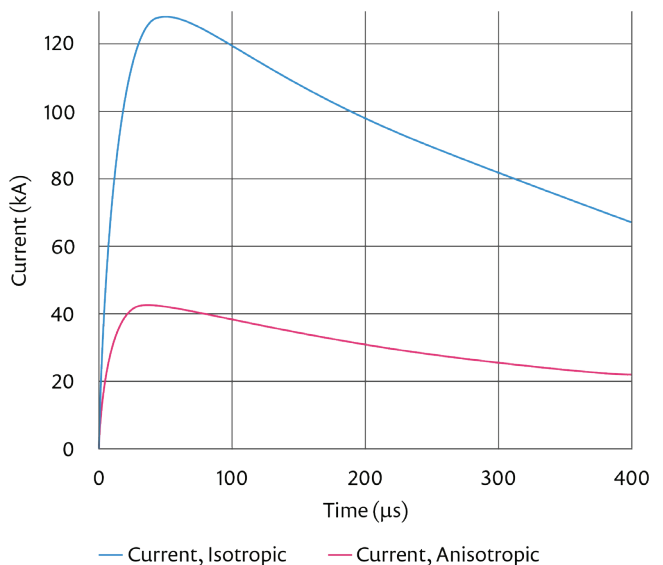

FIGURE 5. A plot demonstrating the current levels in the isotropic and anisotropic carbon cases.



Justin McKennon, leader of the Modeling and Analytical Team, NTS.

COMSOL CONFERENCE 2018

AUGUST 9-10
BANGALORE, INDIA

OCTOBER 3-5
BOSTON,
UNITED STATES

OCTOBER 22-24
LAUSANNE,
SWITZERLAND

NOVEMBER 1-2
SHANGHAI, CHINA

NOVEMBER 9
TAIPEI, TAIWAN

NOVEMBER 23
SEOUL,
SOUTH KOREA

DECEMBER 7
TOKYO, JAPAN

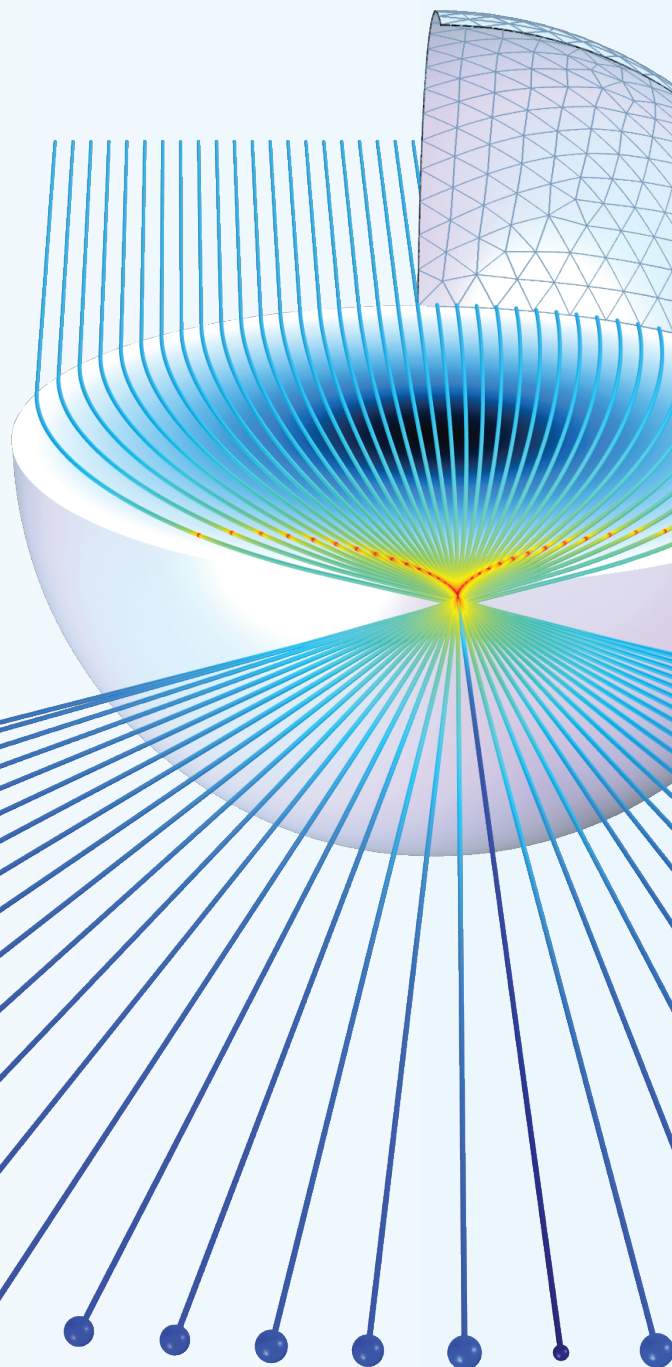

Experience the premier event for
multiphysics simulation.

Register today at:
comsol.com/conference

 COMSOL

STEM Education: Simulation Apps Prepare Students for Life Beyond the Classroom

by **IVANA MILANOVIC, UNIVERSITY OF HARTFORD**

Once upon a time, teaching was easy — we had chalk and boards, practice problems, and homework assignments. Not much changed for many decades, regardless of the tools we worked with: pencil, slide-rule, or calculator. Undergraduate engineering curricula used electives and graduate-level courses to address hot topics and the latest must-know skills. Professors lectured (with or without Socratic discussions) and did a lot of derivations.

Our desire and need to improve student learning and better prepare graduates for a successful career led us to explore various pedagogical models such as problem-, project-, and inquiry-based learning (IBL). However, inquiry requires a significant time-investment, both inside and outside the classroom.

And who has time for that within lecture-based courses, where coverage of the material does not allow for much else? How can we increase the quality of undergraduate science, technology, engineering, and mathematics (STEM) education?

“Our experience has found that the integration of mathematical modeling, numerical simulation, and visualization techniques profoundly impacted our students’ performance inside the classroom and, furthermore, inspired their futures beyond academia.”

Our approach combines problem- and inquiry-based learning, numerical simulations and apps with the COMSOL Multiphysics® software, and emphasizes the importance of outside-of-class learning supported by effective reference materials and faculty mentoring. We also shifted away from focusing on the standard delivery of material and covered what is crucial for our students’ success, which has resulted in more engaged students who, in turn, perform better academically.

At the University of Hartford, we embedded simulation-based design and IBL in two successive junior-year courses: fluid mechanics and heat transfer. Both courses were modified to contain scaffolded and contextualized simulations with application building that develop technical competency in modeling, a deeper understanding of thermofluids concepts by solving realistic technological problems, and writing skills by generating technical reports for each simulation. Apps involve creating a simplified interface that contains the full efficacy of the underlying model without exposing the end user to its complexity. In order to accomplish this, we decided to move away from graded and weighted homework assignments. The

mastery of theory and analytical problems is accomplished by in-class discussions and self-study, while the assessment of theoretical knowledge and analytical skills is based on major exams over the semester.

Accreditation requirements and economic restrictions result in undergraduate engineering curricula that typically do not contain computational fluid dynamics (CFD) courses. However, our experience has found that the integration of mathematical modeling, numerical simulation, and visualization techniques profoundly impacted our students’ performance inside the classroom and, furthermore, inspired their futures beyond academia.

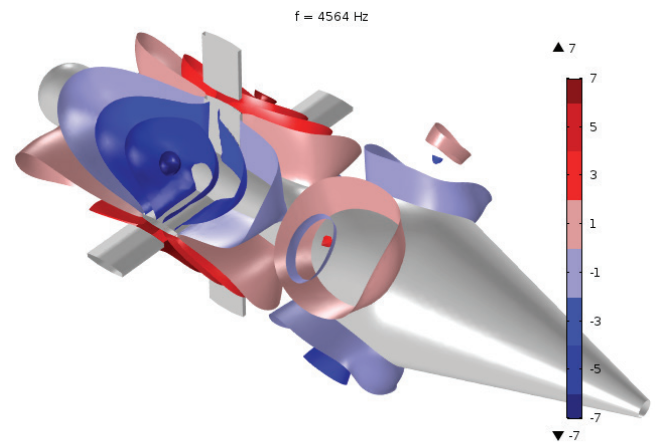

Pressure isosurfaces in a typical multistream nozzle of a jet engine. Image courtesy of Prof. Ivana Milanovic, University of Hartford, Khairul Zaman and Christopher Miller, NASA Glenn Research Center, "Resonance & Tones in Multi-Stream Nozzle Flows", NASA Report 2017. Undergraduate students Iliana Albion-Poles and Jeffrey Severino are continuing this work supported by the Connecticut Space Grant for Faculty Research.



ABOUT THE AUTHOR

Ivana Milanovic is a professor of mechanical engineering at the University of Hartford. She is a contributing author for more than 90 journal articles, NASA reports, conference papers, and software releases. Dr. Milanovic is a member of the Connecticut Academy of Science and Engineering, a body of scientists and engineers in the state that provides support and insight to state agencies and legislature. She received her PhD in mechanical engineering from the Tandon School of Engineering, New York University, and MS and BS from the University of Belgrade, Serbia.